



Aluminium Fabrication Products

Door & Window System Technical Catalog

کاتالوگ فنی سیستم های در و پنجره





EXALCO
Aluminium Fabrication Products

 Made

 in

 IRAN

سیستم EX 55

EX55

درو پنجره (سیستم لولایی) Door & Window

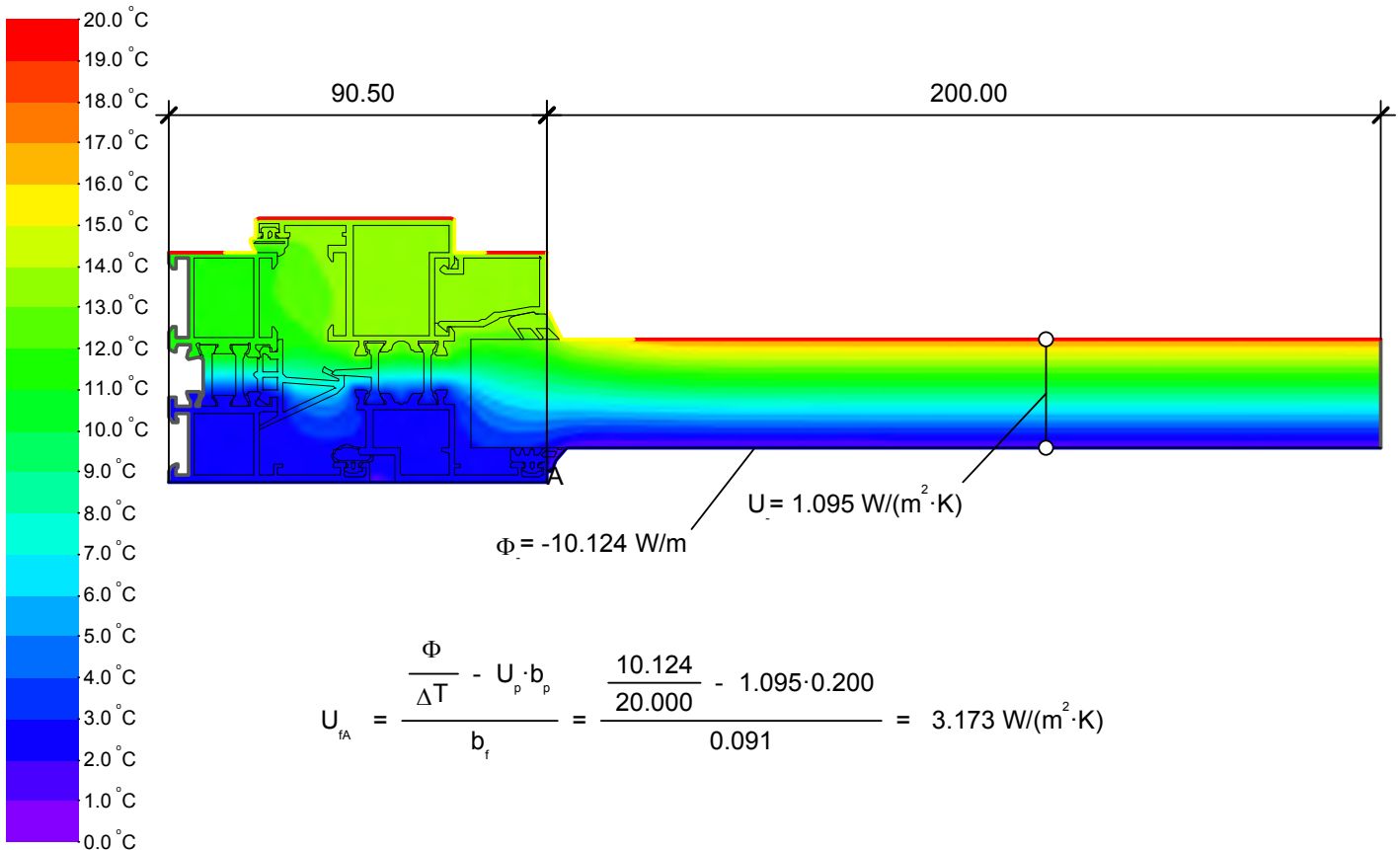
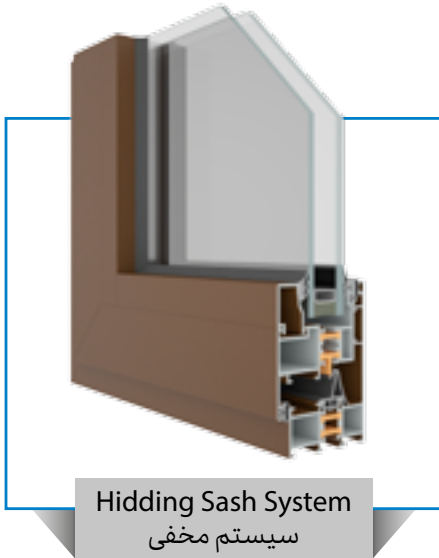

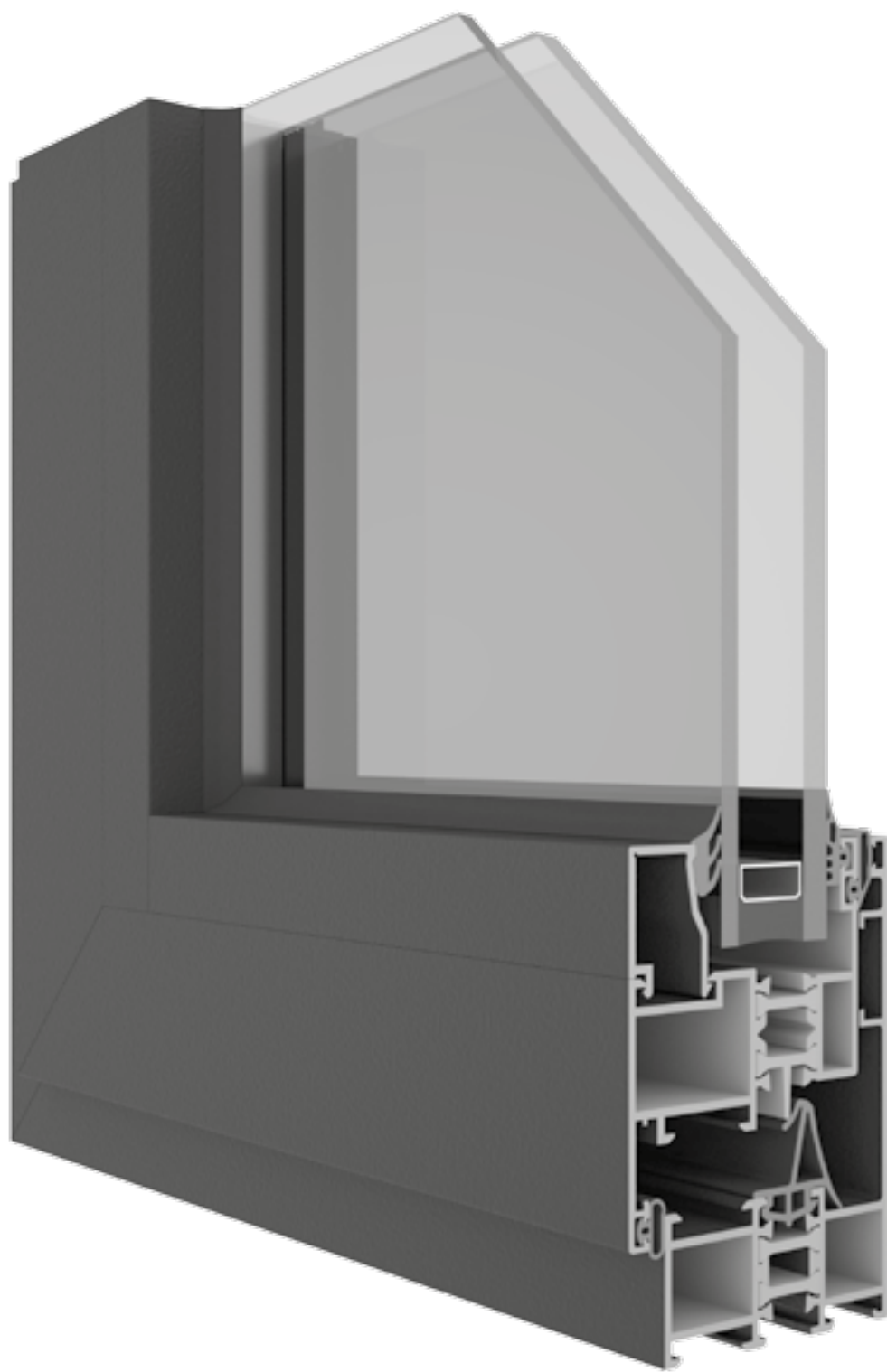

Profile No.	Weight (kg/m)	Static Value
کد پروفیل	وزن پروفیل	Jx (cm ⁴) Jy (cm ⁴)
EX-55 10048-15	1.146 kg/m	13.89 / 4.27
EX-55 10058-15	1.322 kg/m	16.85 / 8.66
EX-55 10078-15	1.647 kg/m	18.78 / 29.47
EX-55 15058-15	1.439 kg/m	23.59 / 9.58

پروفیل‌های چهارچوب

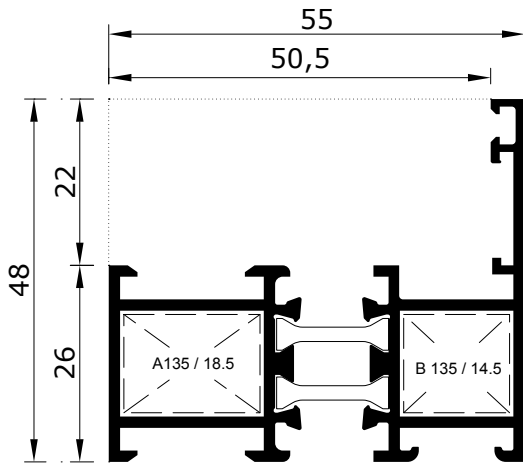

EX-55 10048-15

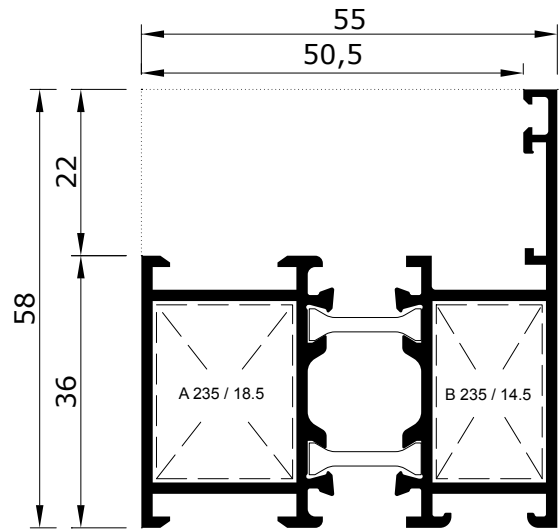

EX-55 10058-15

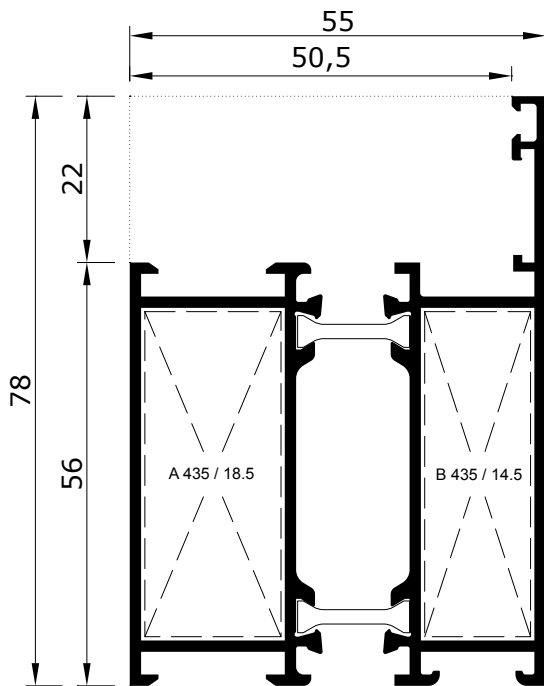

EX-55 10078-15

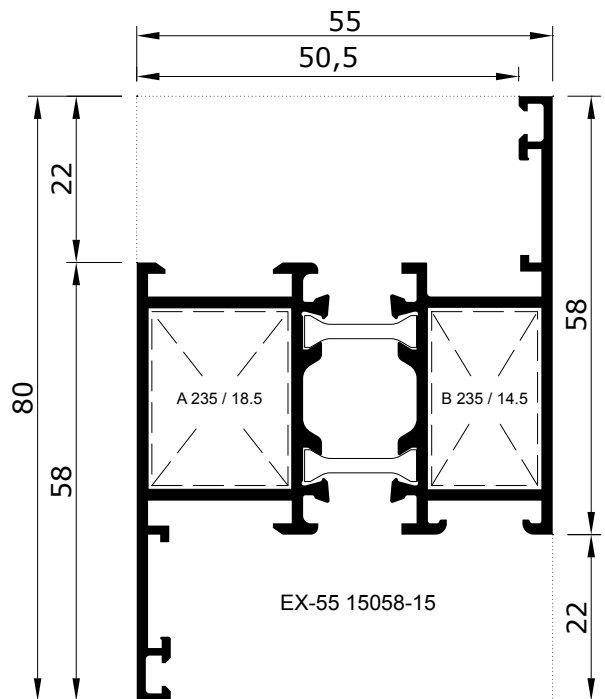

EX-55 15058-15

Profile No. کد پروفیل	Weight (kg/m) وزن پروفیل	Static Value Jx (cm ⁴) Jy (cm ⁴)
EX-55 14048-15	1.409 kg/m	26.16 / 6.47
EX-55 14058-15	1.585 kg/m	31.02 / 12.22
EX-55 14078-15	1.911 kg/m	44.72 / 29.3

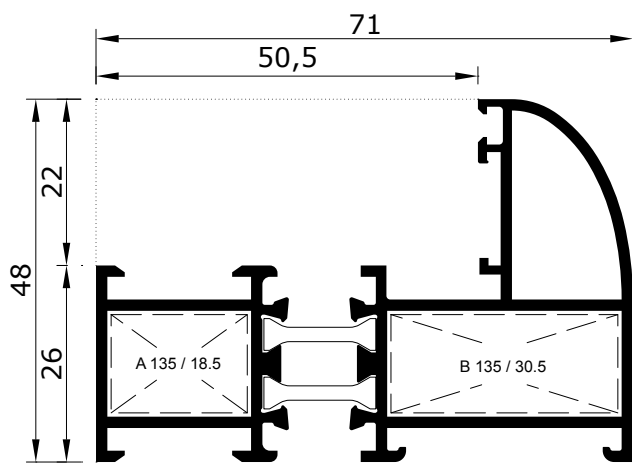

EX-55 14048-15

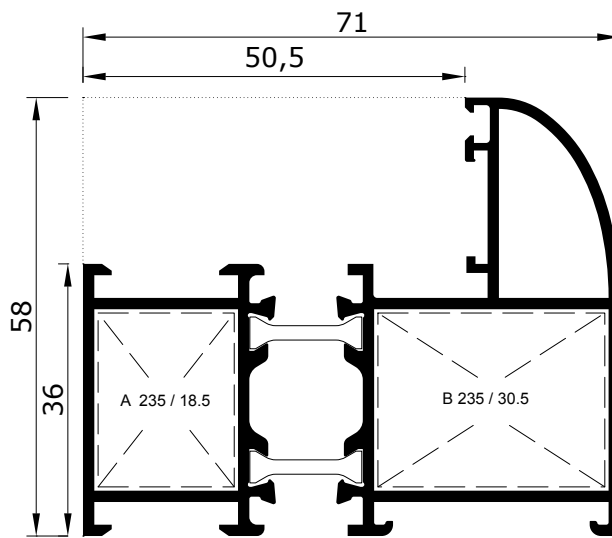

EX-55 14058-15

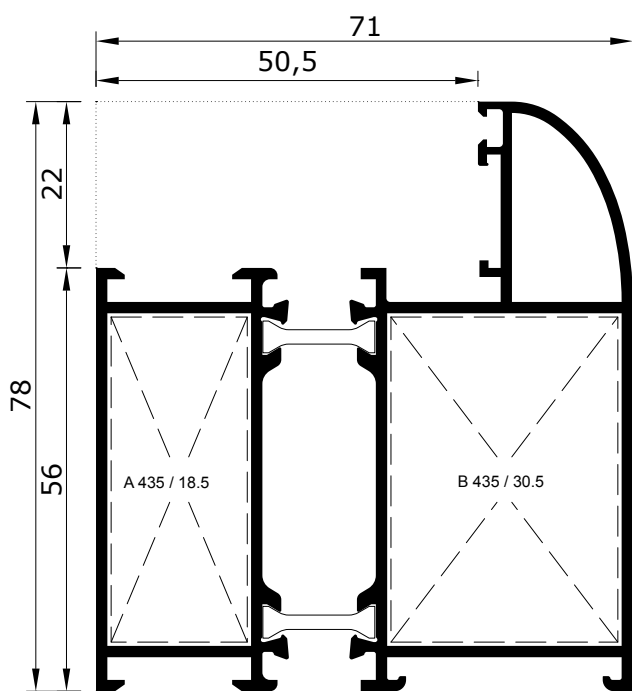

EX-55 14078-15

Profile No.	Weight (kg/m)	Static Value
کد پروفیل	وزن پروفیل	Jx (cm ⁴) Jy (cm ⁴)
EX-55 20070-15	1.249kg/m	15.27 / 7.90
EX-55 20080-15	1.425 kg/m	17.75 / 14.00
EX-55 20100-15	1.750 kg/m	22.59 / 34.88

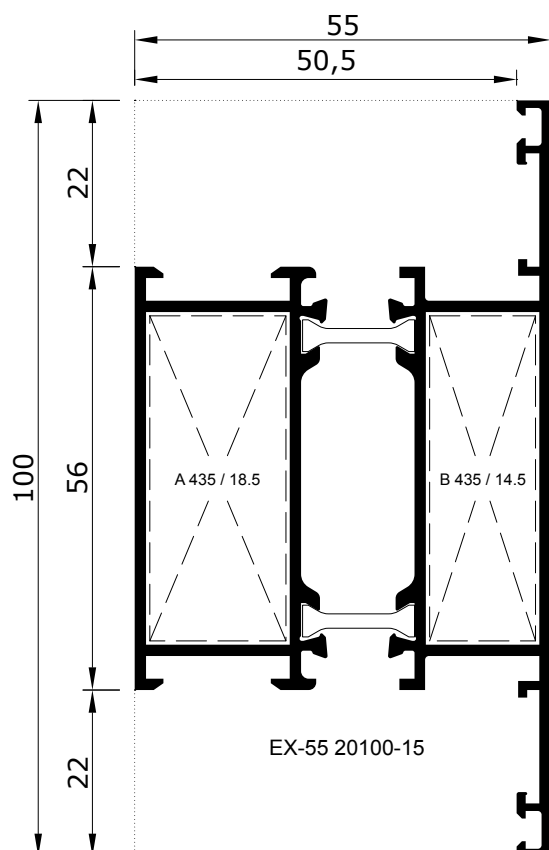
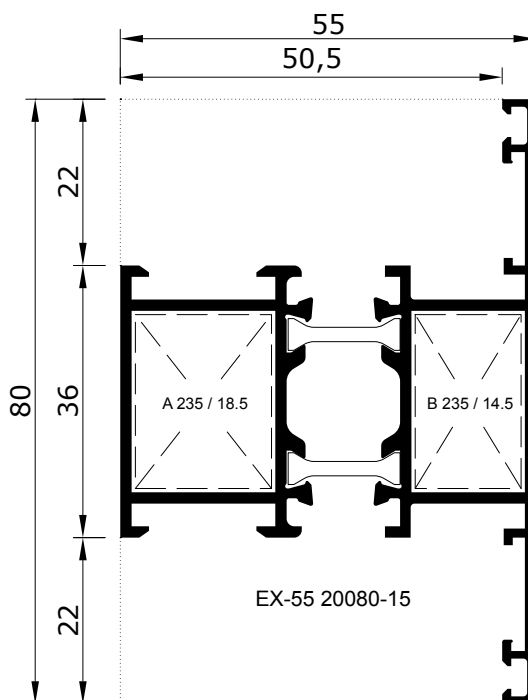
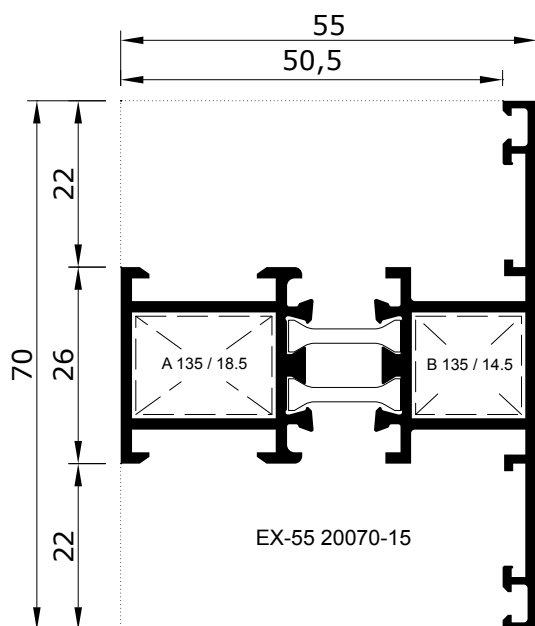

Profile No.	Weight (kg/m)	Static Value
کد پروفیل	وزن پروفیل	Jx (cm ⁴) Jy (cm ⁴)
EX-55 20135-15	2.319 kg/m	30.99 / 105.52
EX-55 60135-15	2.436 kg/m	

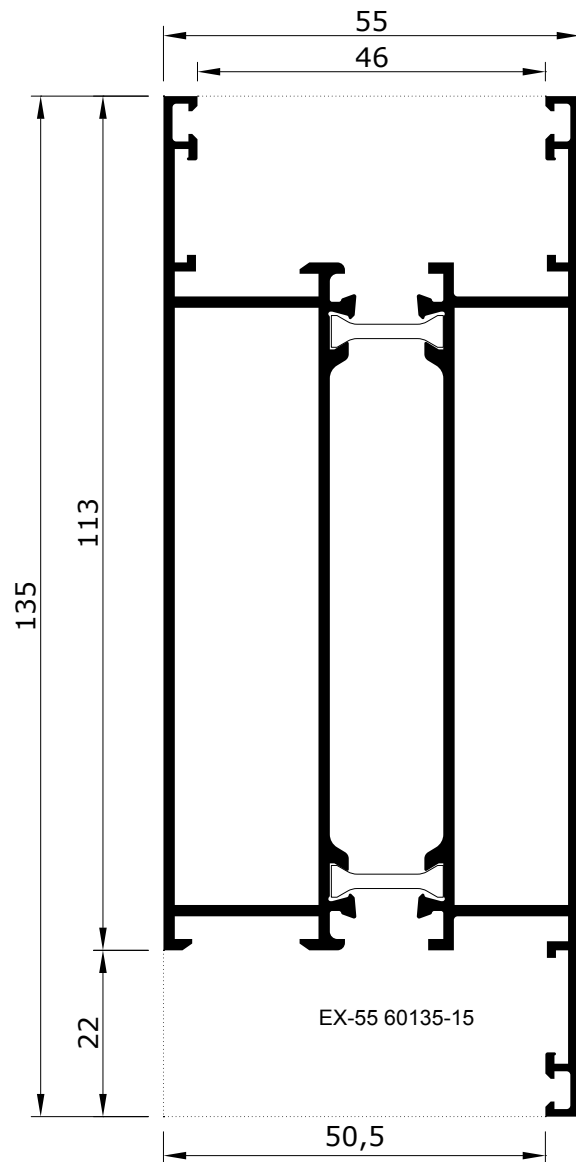
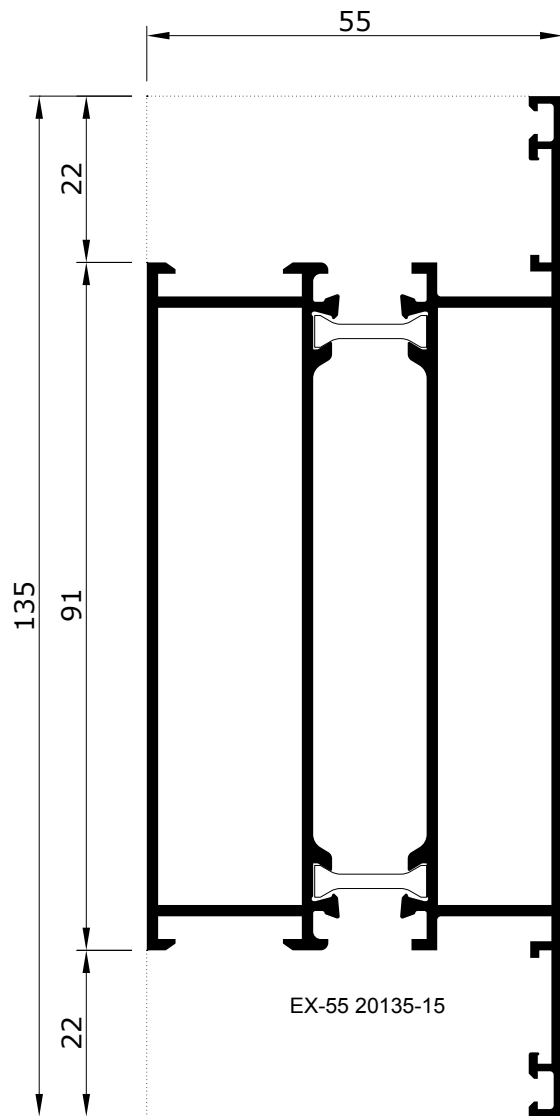

Profile No.	Weight (kg/m)	Static Value
کد پروفیل	وزن پروفیل	Jx (cm ⁴) Jy (cm ⁴)
EX-55 30080-15	1.496 kg/m	
EX-55 30070-15	1.334 kg/m	
EX-55 30100-15	1.822 kg/m	

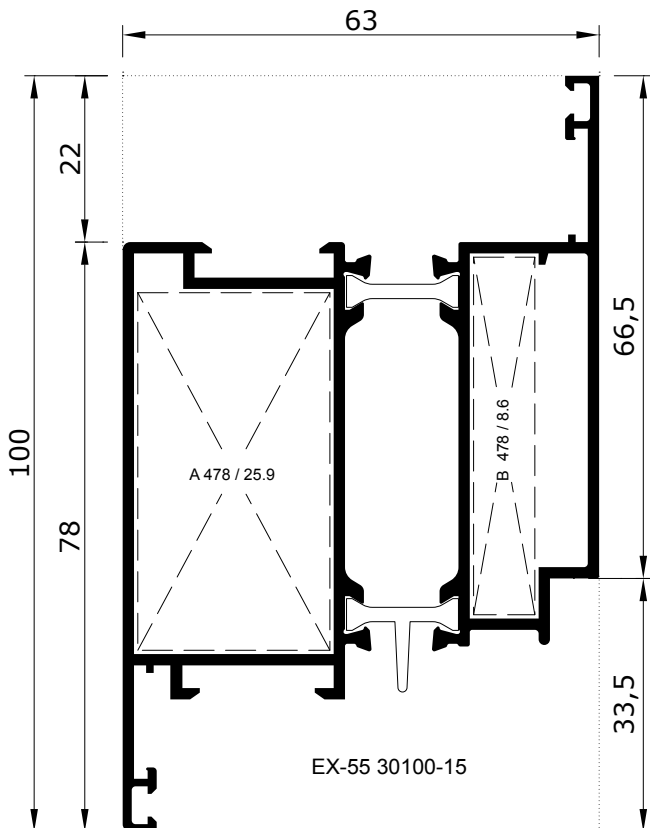
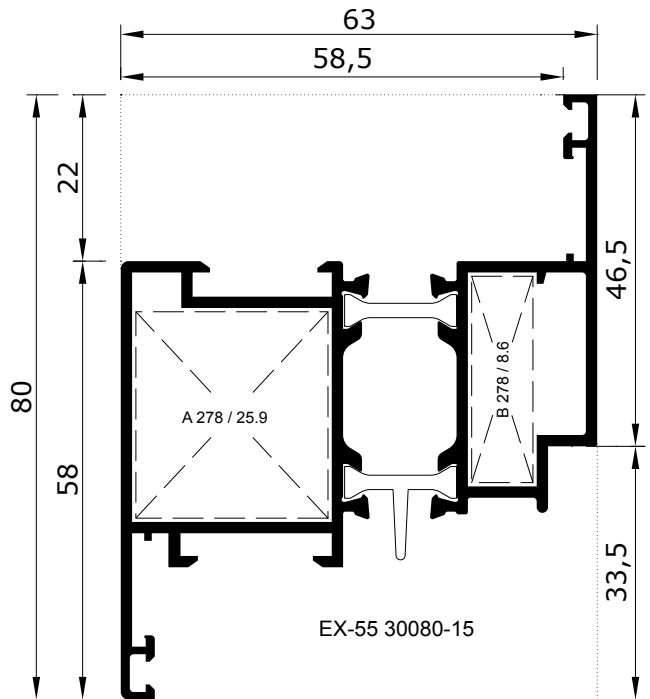
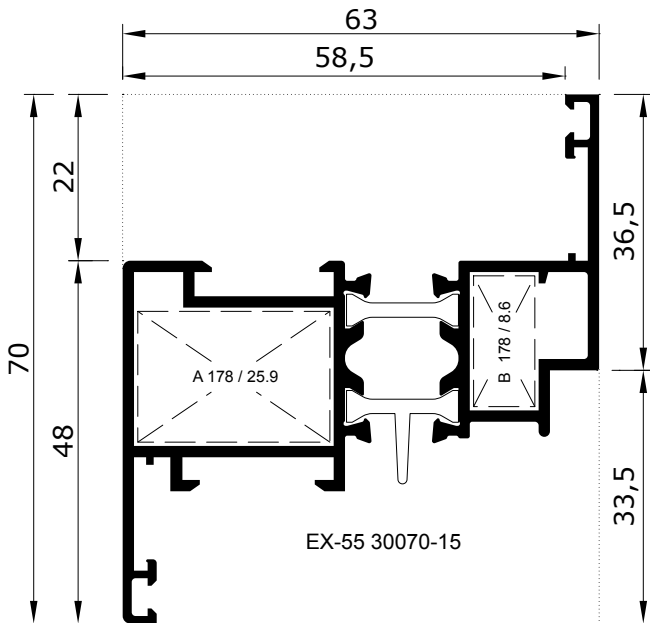

Profile No. کد پروفیل	Weight (kg/m) وزن پروفیل	Static Value Jx (cm ⁴) Jy (cm ⁴)
EX-55 34070-15	1.484 kg/m	
EX-55 34080-15	1.646 kg/m	
EX-55 34100-15	1.972 kg/m	

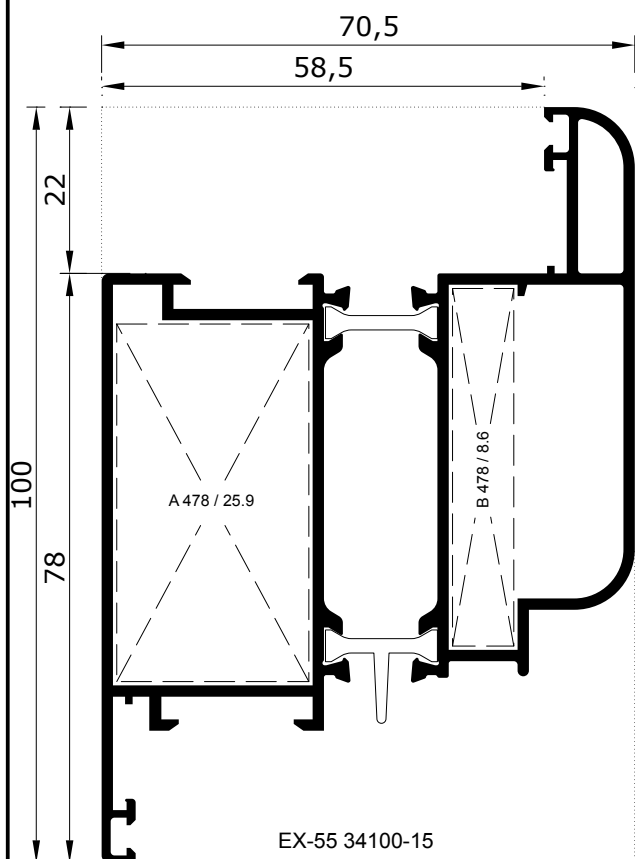
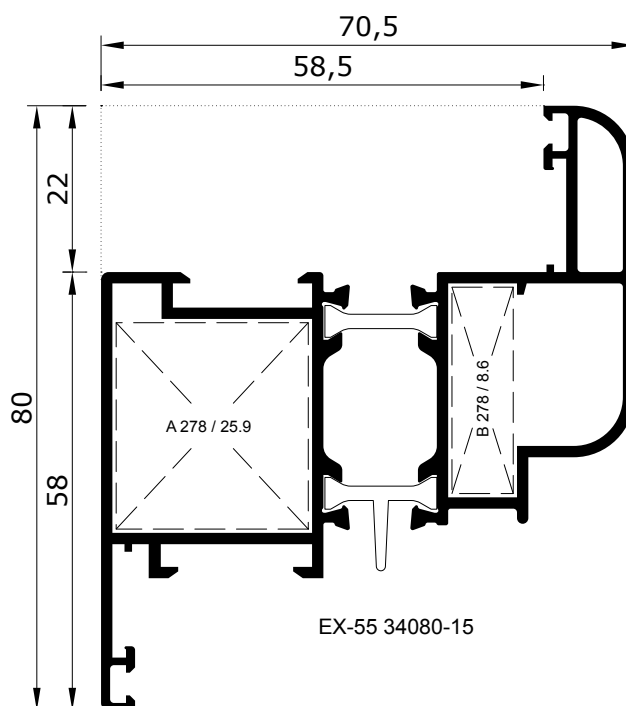
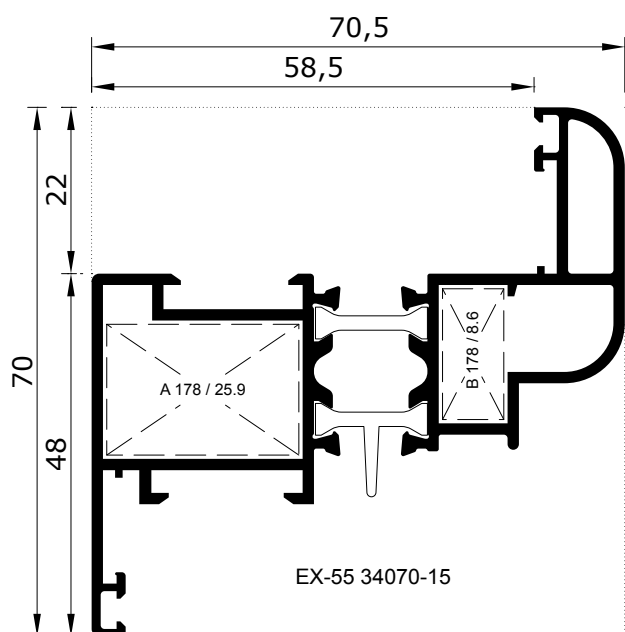

Profile No.	Weight (kg/m)	Static Value
کد پروفیل	وزن پروفیل	Jx (cm ⁴) Jy (cm ⁴)
EX-55 39100-15	1.913 kg/m	
EX-55 49050-15	1.200 kg/m	
EX-55 40061-15	1.255 kg/m	
EX-55 Panel	0.625 kg/m	

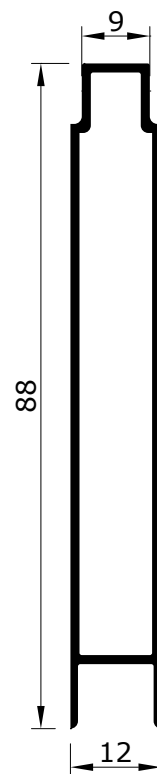
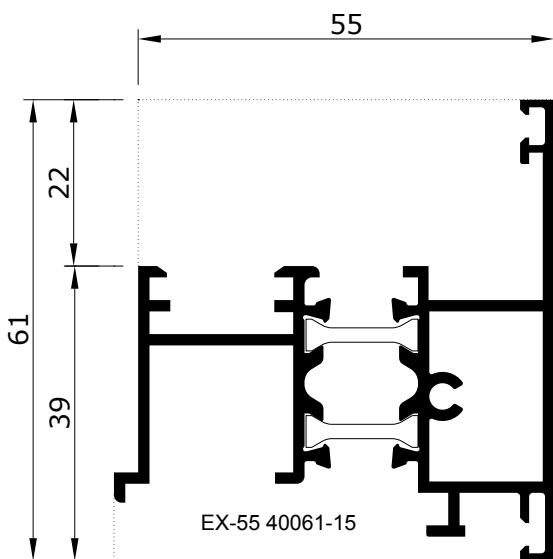
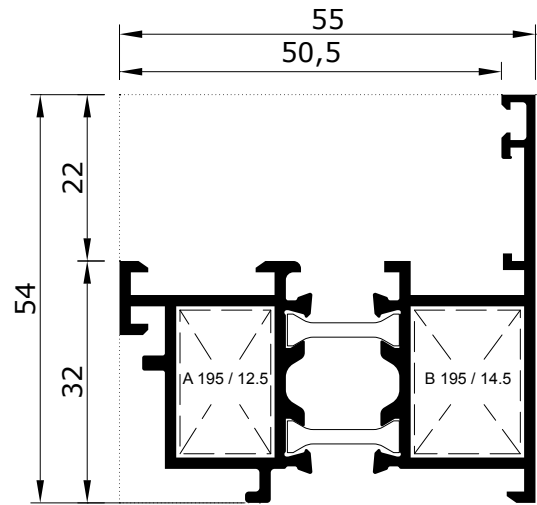
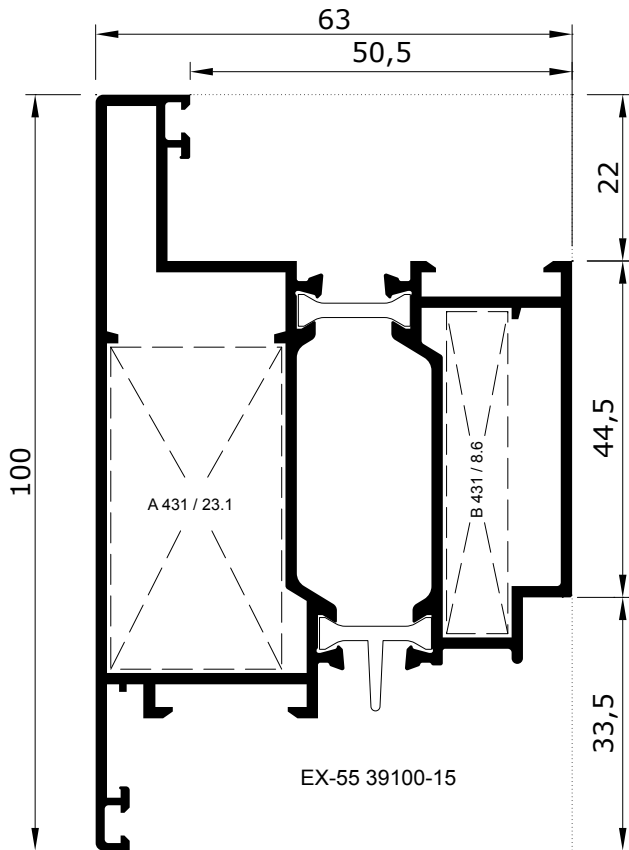

Profile No.	Weight (kg/m)	Static Value
کد پروفیل	وزن پروفیل	Jx (cm ⁴) Jy (cm ⁴)
EX-55 40100-15	1.125 kg/m	
EX-55 40100-15-C	0.865 kg/m	
EX-55 40075-15	1.376 kg/m	
EX-55 40077-15	1.117 kg/m	
EX-55 40076-15	0.161 kg/m	
EX-55 45055-15	0.383 kg/m	

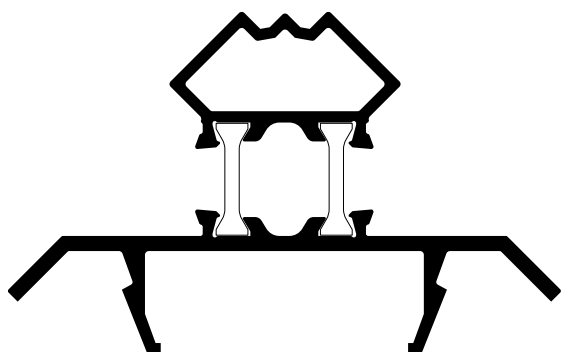

EX-55 40100-15

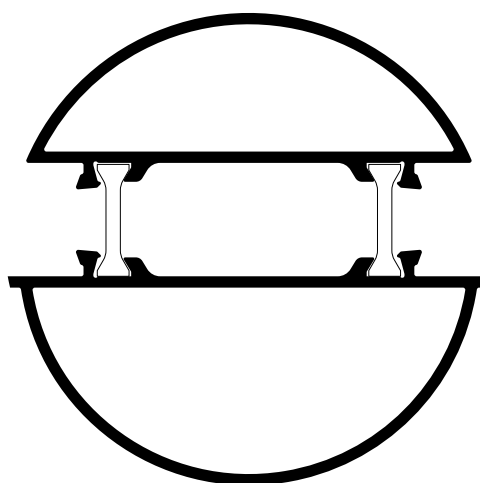

EX-55 40075-15

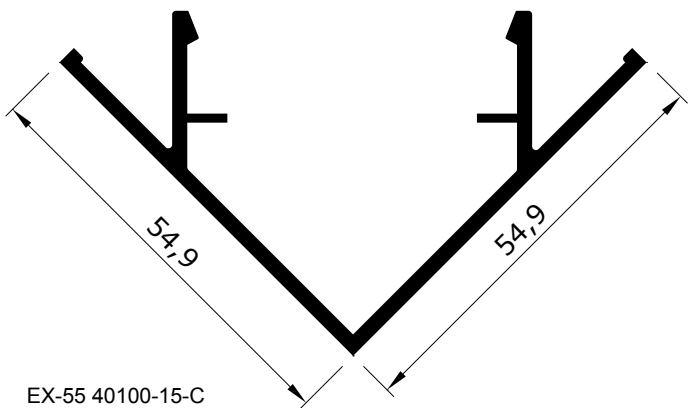

EX-55 40100-15-C

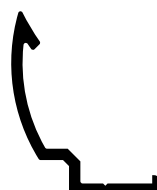

EX-55 40076-15



EX-55 40077-15

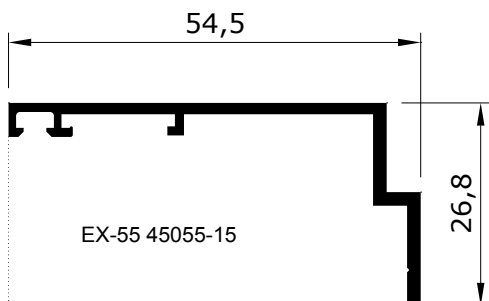

EX-55 45055-15

Profile No.	Weight (kg/m)	Static Value
کد پروفیل	وزن پروفیل	Jx (cm ⁴) Jy (cm ⁴)
EX-55 12088-15	1.349 kg/m	9.68 / 33.63
EX-55 22110-15	1.452 kg/m	14.29 / 35.51
EX-55 32070-15	1.220 kg/m	
EX-55 42040-15	0.526 kg/m	

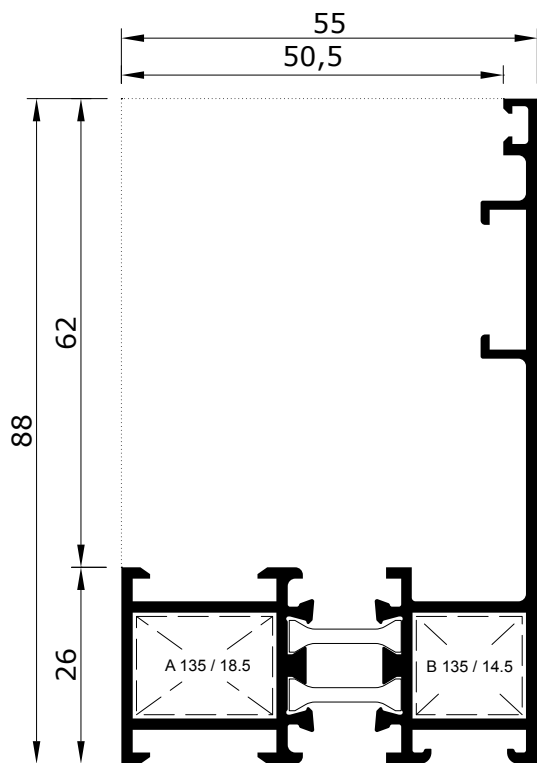

EX-55 12088-15

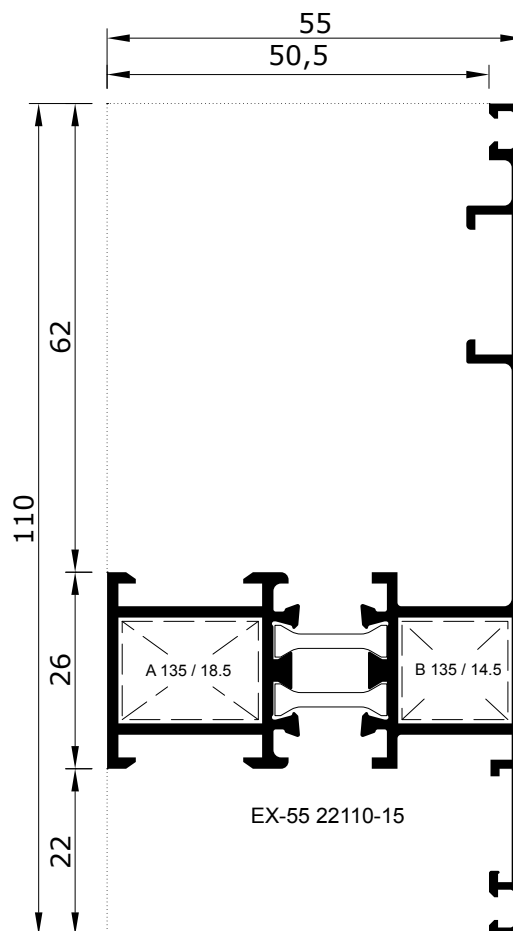

EX-55 22110-15

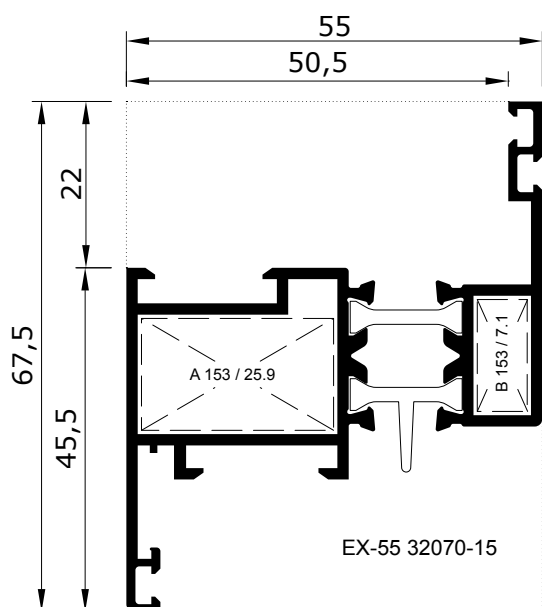

EX-55 32070-15

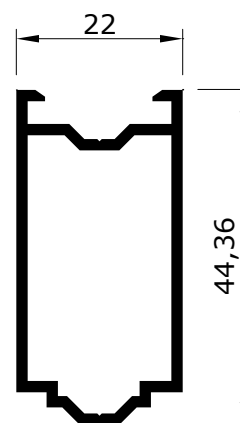

EX-55 42040-15

Profile No.	Weight (kg/m)	Static Value
کد پروفیل	وزن پروفیل	Jx (cm ⁴) Jy (cm ⁴)
EX-55 22150-15	1.655 kg/m	20.29 / 62.81
EX-55 42150-15	1.704 kg/m	

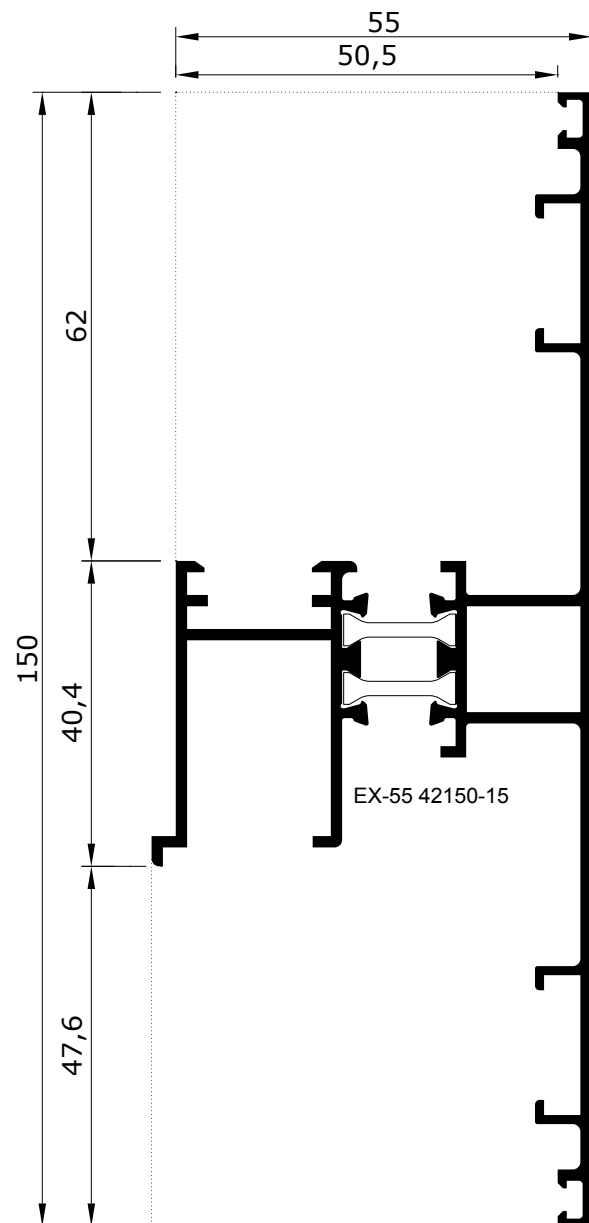
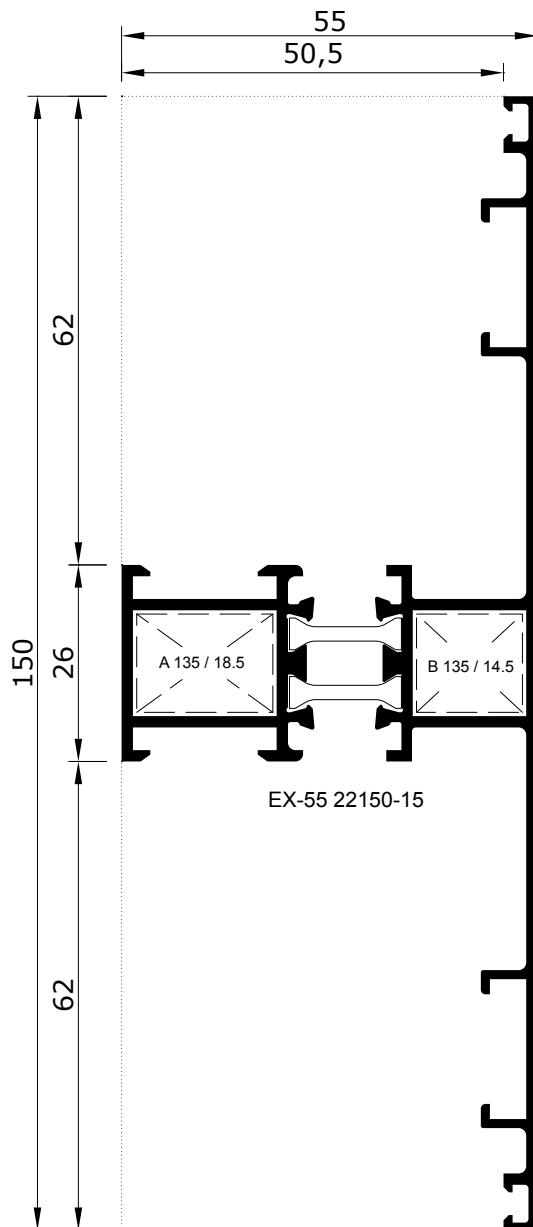

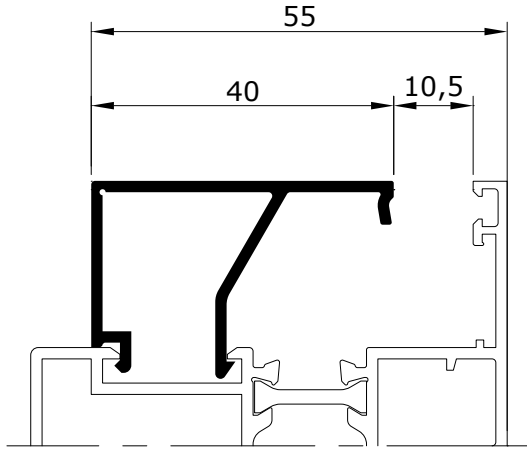

EX 50040-15
0.407 kg/m

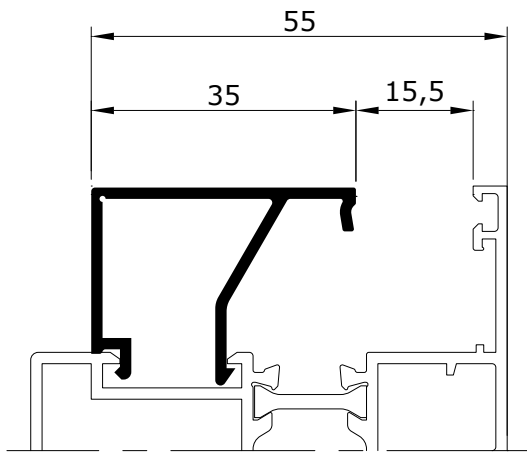
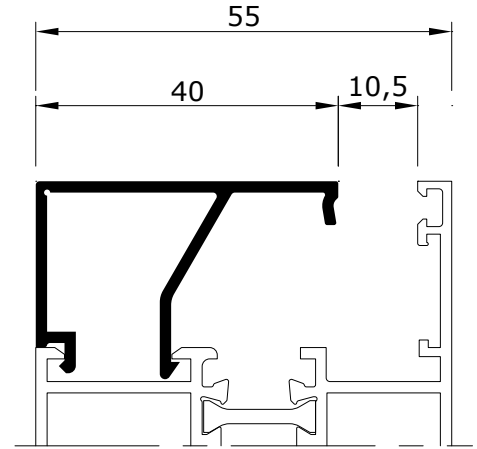

EX 50035-15
0.387 kg/m

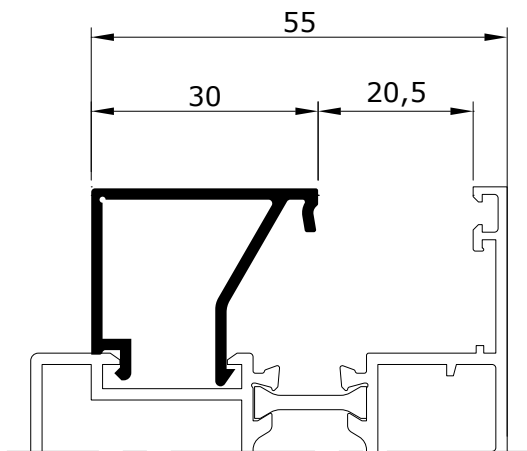
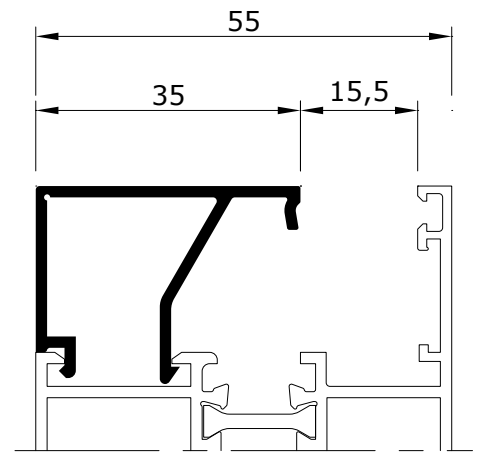

EX 50030-15
0.367 kg/m

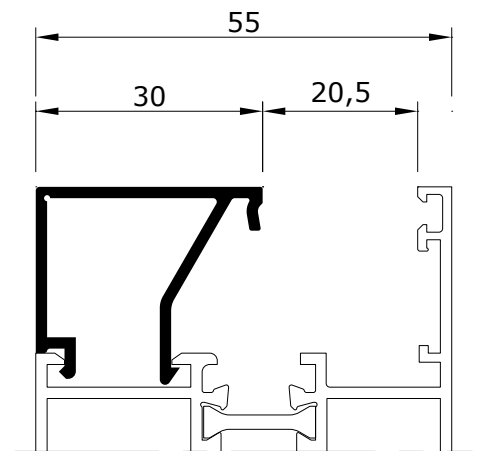

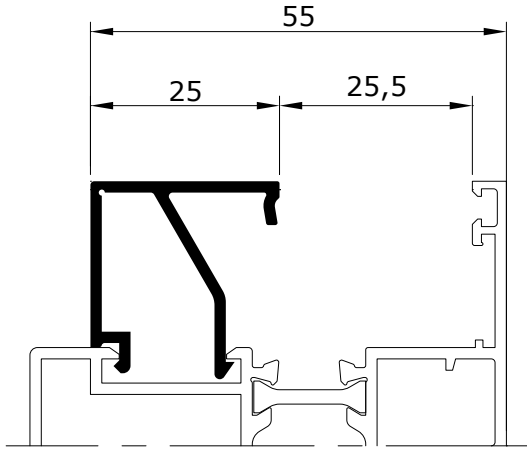

EX 50025-15
0.346 kg/m

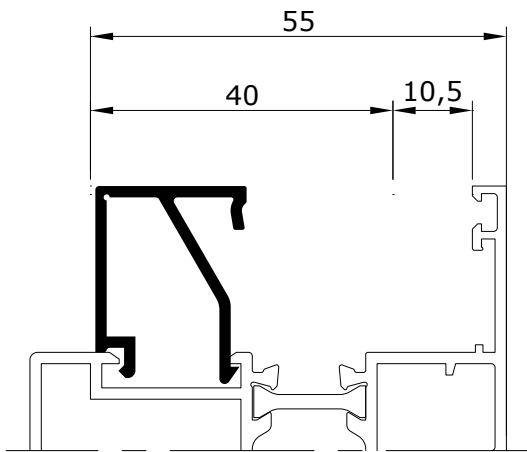
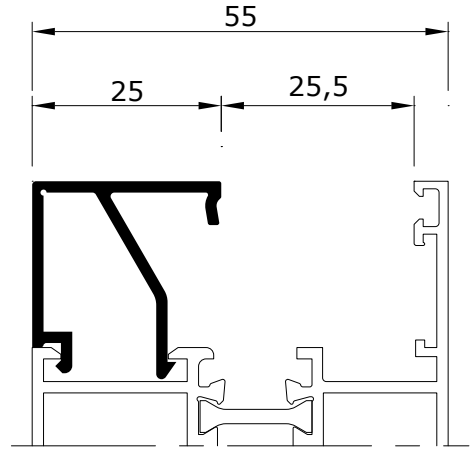

EX 50020-15
0.326 kg/m

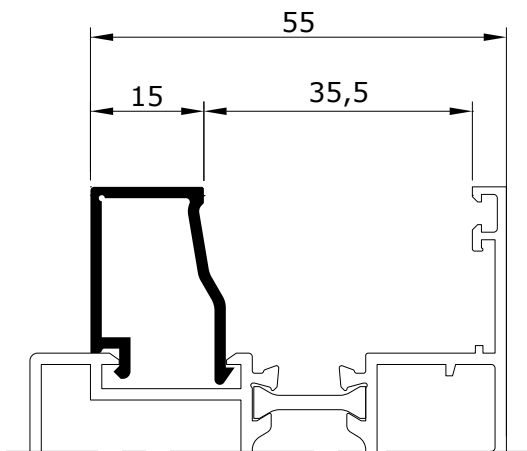
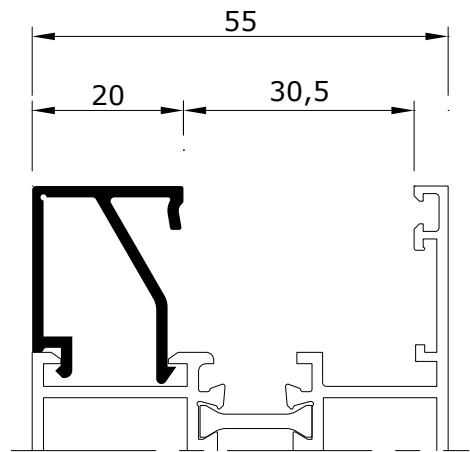

EX 50015-15
0.282 kg/m

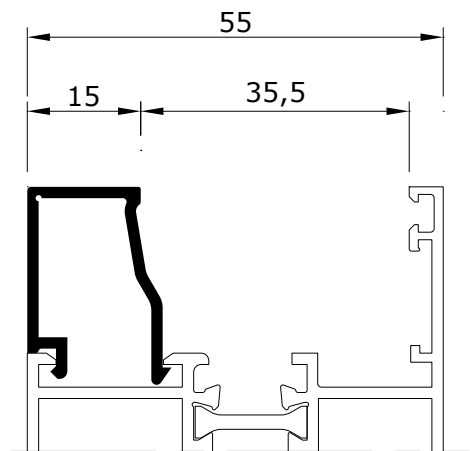

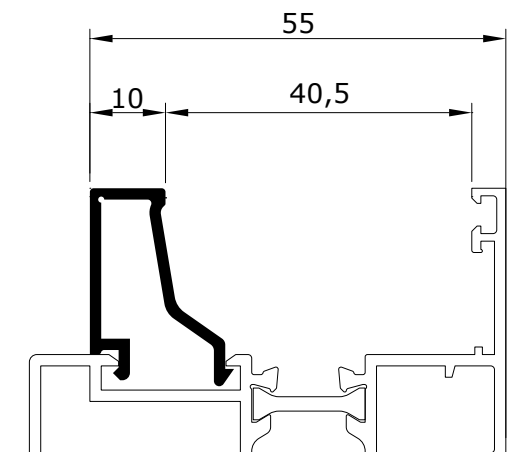

EX 50010-15
0.273 kg/m

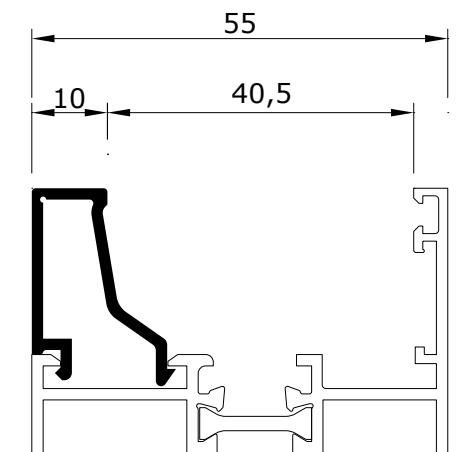

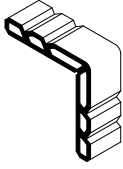
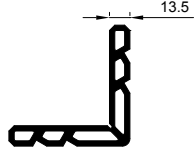
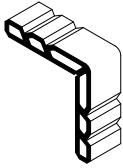
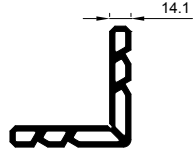
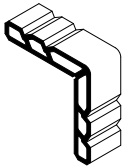
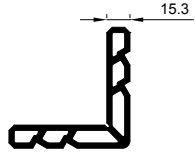
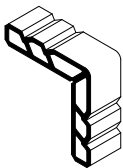
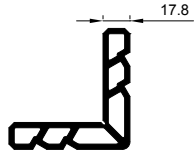
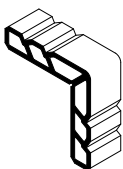
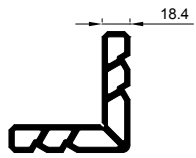
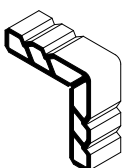
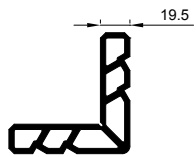
3D Picture تصوير سه بعدی	2D Picture تصوير محصول	Features مشخصات فنی	Used Profiles پروفیل مصرفی
		PC-135 3.256 Kg/m	EX-55 10048-15 EX-55 14048-15 EX-55 20070-15 EX-55 22110-15 EX-55 12088-15 EX-55 22150-15
		PC-141 3.307 Kg/m	EX-55 10048-12 EX-55 14048-12 EX-55 20070-12
		PC-153 3.344 Kg/m	EX-55 32070-15
		PC-178 3.507 Kg/m	EX-55 30070-15 EX-55 34070-15
		PC-184 3.546 Kg/m	EX-55 30070-12 EX-55 34070-12
		PC-195 3.618 Kg/m	EX-55 49050-15

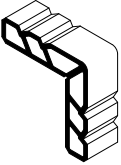
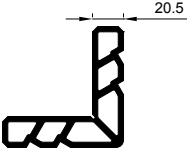
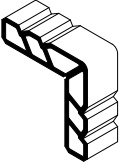
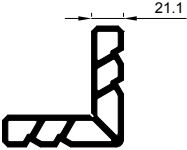
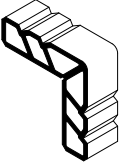
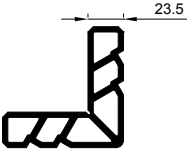
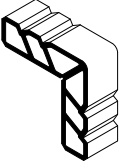
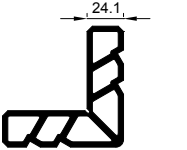
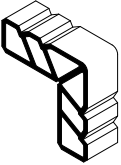
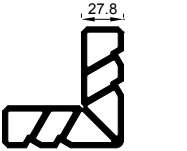
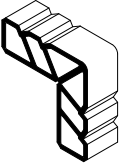
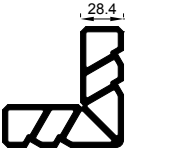
3D Picture تصویر سه بعدی	2D Picture تصویر محصول	Features مشخصات فنی	Used Profiles پروفیل مصرفی
		PC-205 3.684 Kg/m	EX-55 35080-15
		PC-211 3.723 Kg/m	EX-55 35080-12 EX-55 35480-12
		PC-325 3.880 Kg/m	EX-55 10058-15 EX-55 14058-15 EX-55 15058-15 EX-55 20080-15
		PC-241 3.919 Kg/m	EX-55 10058-15 EX-55 14058-12 EX-55 20080-12
		PC-278 4.162 Kg/m	EX-55 30080-15 EX-55 34080-15 EX-55 35480-15 EX-55 35080-15
		PC-284 4.202 Kg/m	EX-55 30080-12 EX-55 35080-12 EX-55 34080-12 EX-55 35480-12

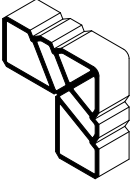
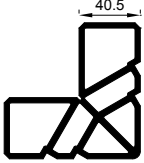
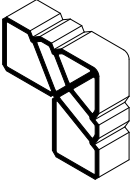
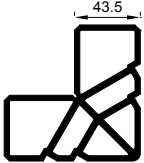
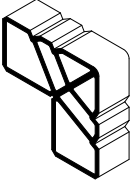
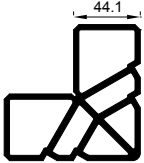
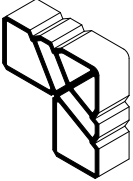
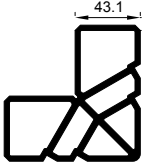
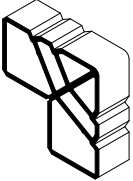
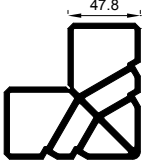
3D Picture تصویر سه بعدی	2D Picture تصویر محصول	Features مشخصات فنی	Used Profiles پروفیل مصرفی
		<p>PC-405</p> <p>5.101 Kg/m</p>	<p>EX-55 35499-15</p> <p>EX-55 35100-15</p>
		<p>PC-435</p> <p>5.196 Kg/m</p>	<p>EX-55 10078-15</p> <p>EX-55 14078-15</p> <p>EX-55 20100-15</p>
		<p>PC-441</p> <p>5.217 Kg/m</p>	<p>EX-55 10078-12</p> <p>EX-55 14078-12</p> <p>EX-55 20100-12</p>
		<p>PC-431</p> <p>5.191Kg/m</p>	<p>EX-55 39100-15</p>
		<p>PC-478</p> <p>5.260 Kg/m</p>	<p>EX-55 30100-15</p> <p>EX-55 34100-15</p> <p>EX-55 35499-15</p> <p>EX-55 35100-15</p>

3D Picture تصویر سه بعدی	2D Picture تصویر محصول	Features مشخصات فنی	Used Profiles پروفیل مصرفی
		GC-135 1.712 Kg/m	EX-55 10048-15 EX-55 14048-15 EX-55 20070-15 EX-55 22110-15 EX-55 12088-15 EX-55 22150-15
		GC-141 1.748 Kg/m	EX-55 10048-12 EX-55 14048-12 EX-55 20070-12
		GC-153 1.830 Kg/m	EX-55 32070-15
		GC-178 2.044 Kg/m	EX-55 30070-15 EX-55 34070-15
		GC-184 2.053 Kg/m	EX-55 30070-12 EX-55 34070-12
		GC-195 2.069 Kg/m	EX-55 49050-15

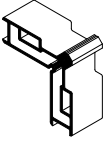
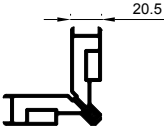
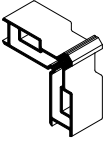
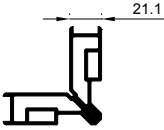
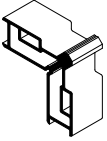
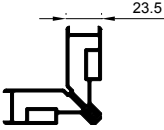
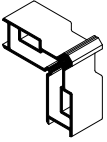
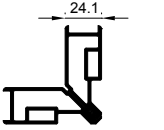
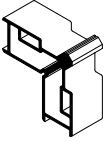
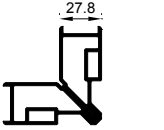
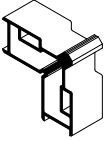
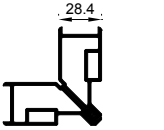
3D Picture تصویر سه بعدی	2D Picture تصویر محصول	Features مشخصات فنی	Used Profiles پروفیل مصرفی
		GC-205 2.084 Kg/m	EX-55 35080-15
		GC-211 2.093 Kg/m	EX-55 35080-12 EX-55 35480-12
		GC-235 2.128 Kg/m	EX-55 10058-15 EX-55 14058-15 EX-55 15058-15 EX-55 20080-15
		GC-241 2.137 Kg/m	EX-55 10058-15 EX-55 14058-12 EX-55 20080-12
		GC-278 2.191 Kg/m	EX-55 30080-15 EX-55 34080-15 EX-55 35480-15 EX-55 35080-15
		GC-284 2.199 Kg/m	EX-55 30080-12 EX-55 35080-12 EX-55 34080-12 EX-55 35480-12

تصویر محصول Picture	کد محصول Piece No.	نوع متریال Material	مشخصات فنی Description
	GP-200	TPV/NBR	لاستیک ۲ میل داخلی Interior Glazing Gasket 2 mm
	GP-300		لاستیک ۳/۵ میل داخلی Interior Glazing Gasket 3.5 mm
	GP-400		لاستیک ۵ میل داخلی Interior Glazing Gasket 5 mm
	GP500		لاستیک ۶/۵ میل داخلی Interior Glazing Gasket 6.5 mm
	GP-100		لاستیک لنگه داخلی Interior Overlap Gasket
	GP-550		لاستیک کله غازی Central Gasket
	GP600		لاستیک پشت شیشه Exterior Glazing Gasket
	GH-100		لاستیک سیستم لنگه مخفی Exterior Glazing Gasket For Hidden Sash
	GP-150		لاستیک خارجی لنگه Exterior Overlap Gasket

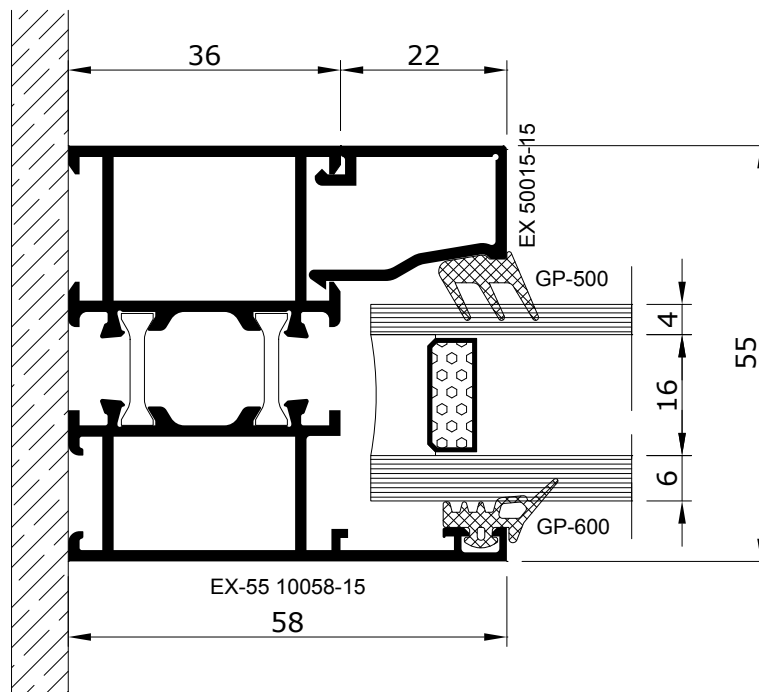
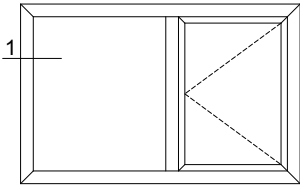

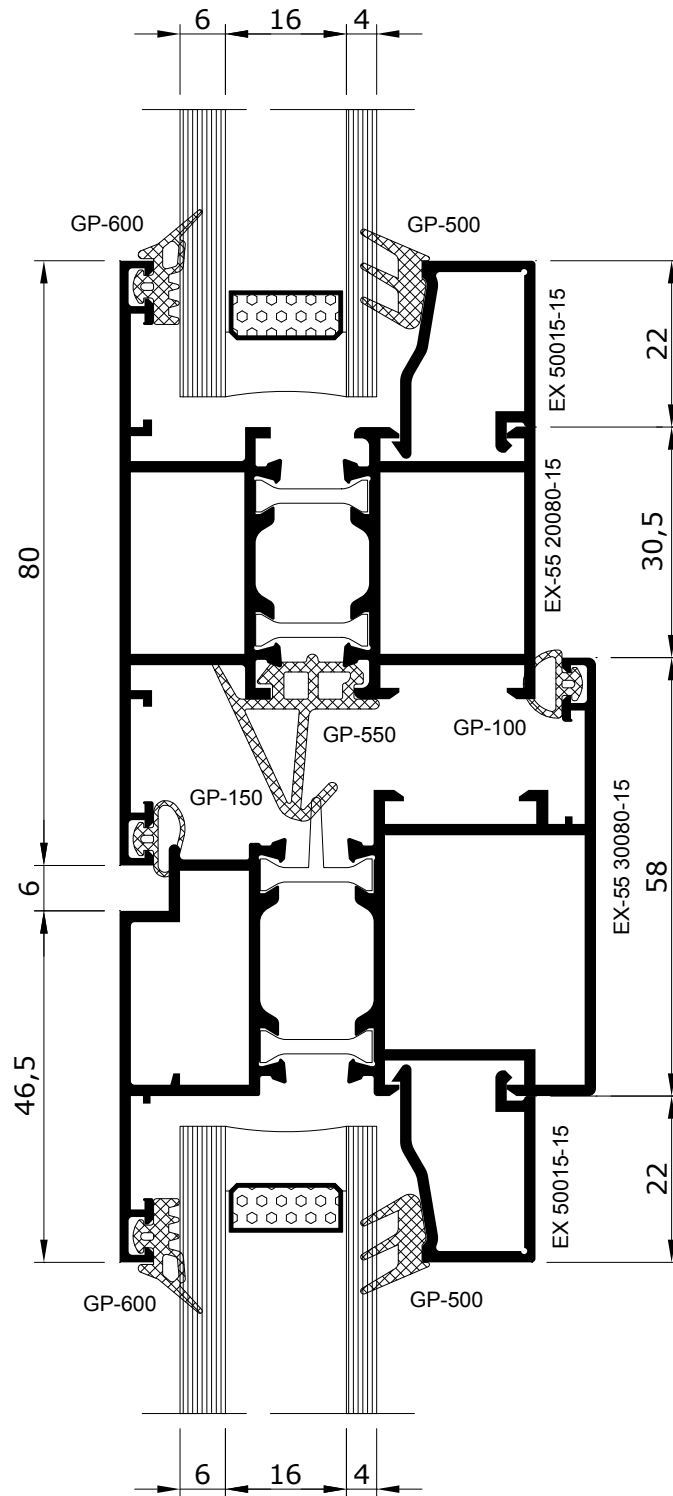
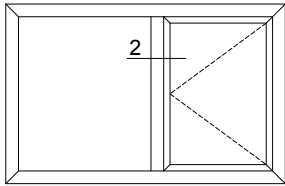

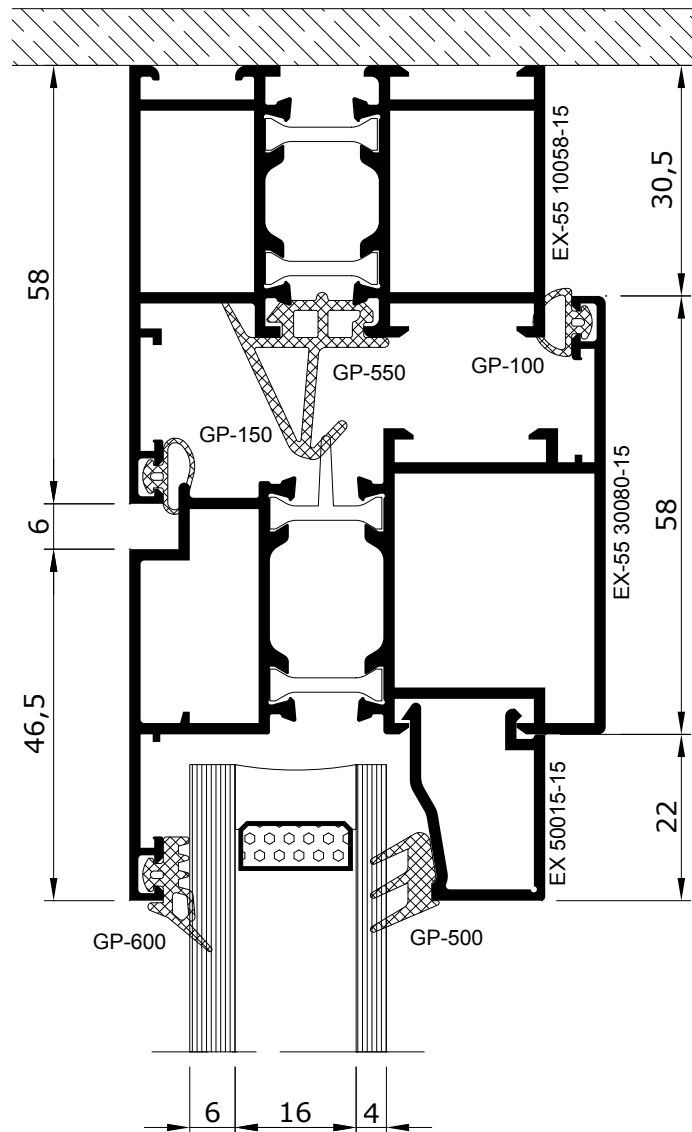
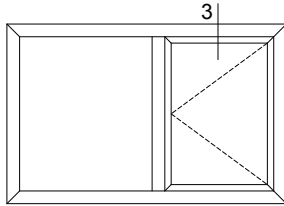

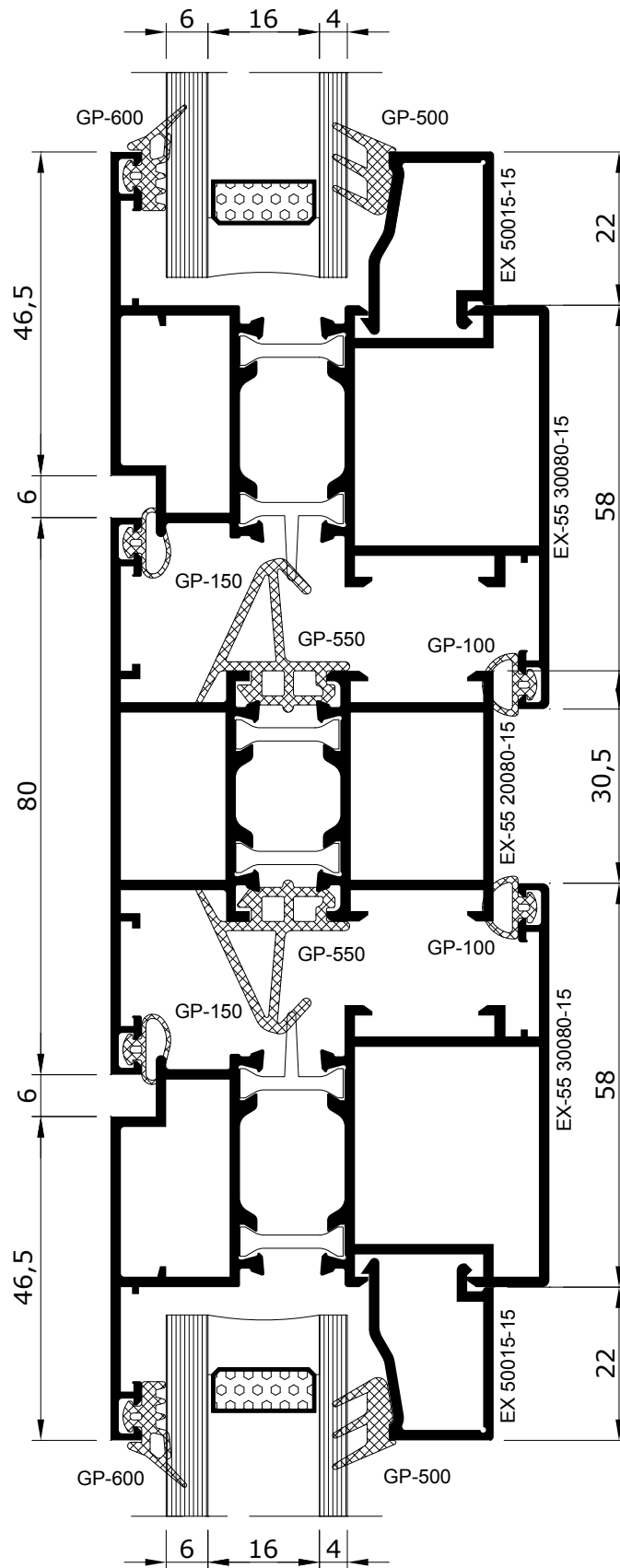
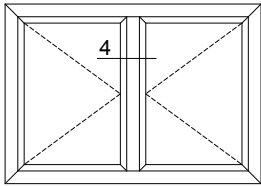

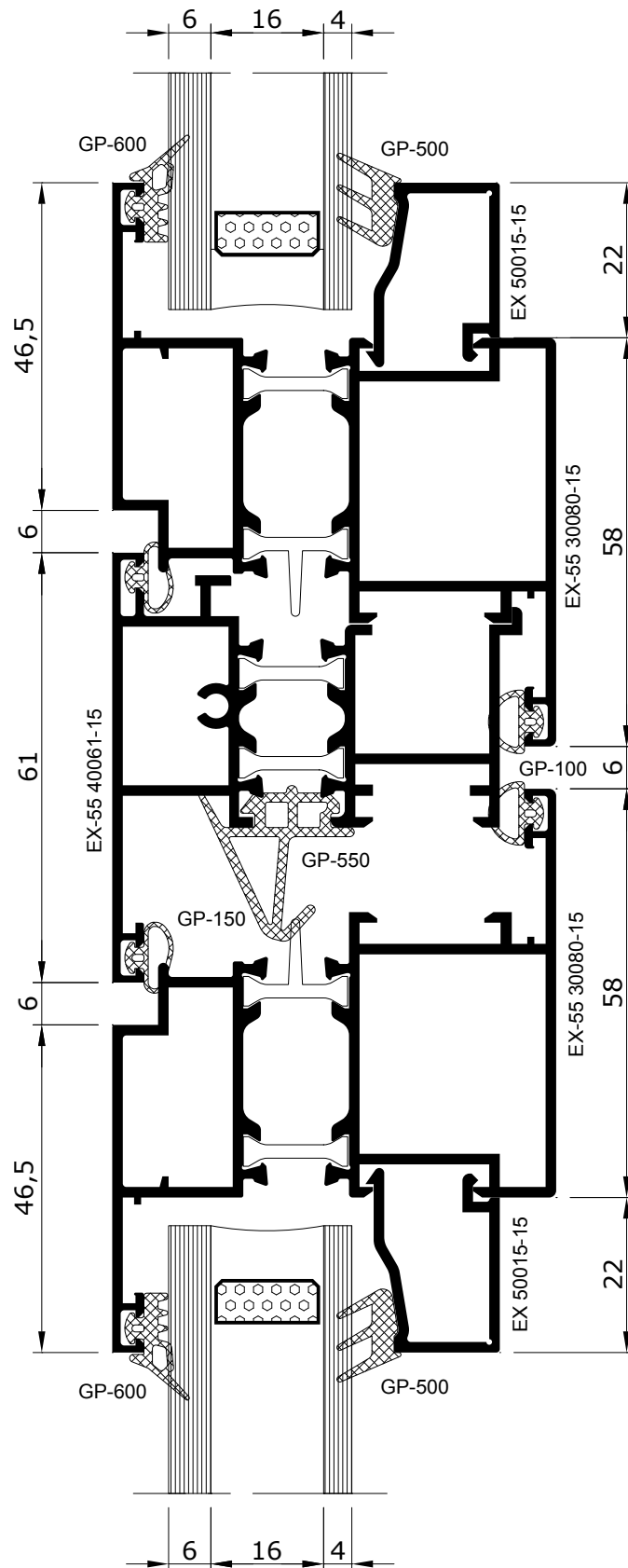
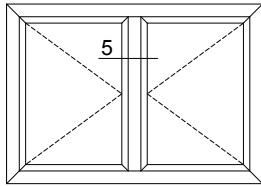

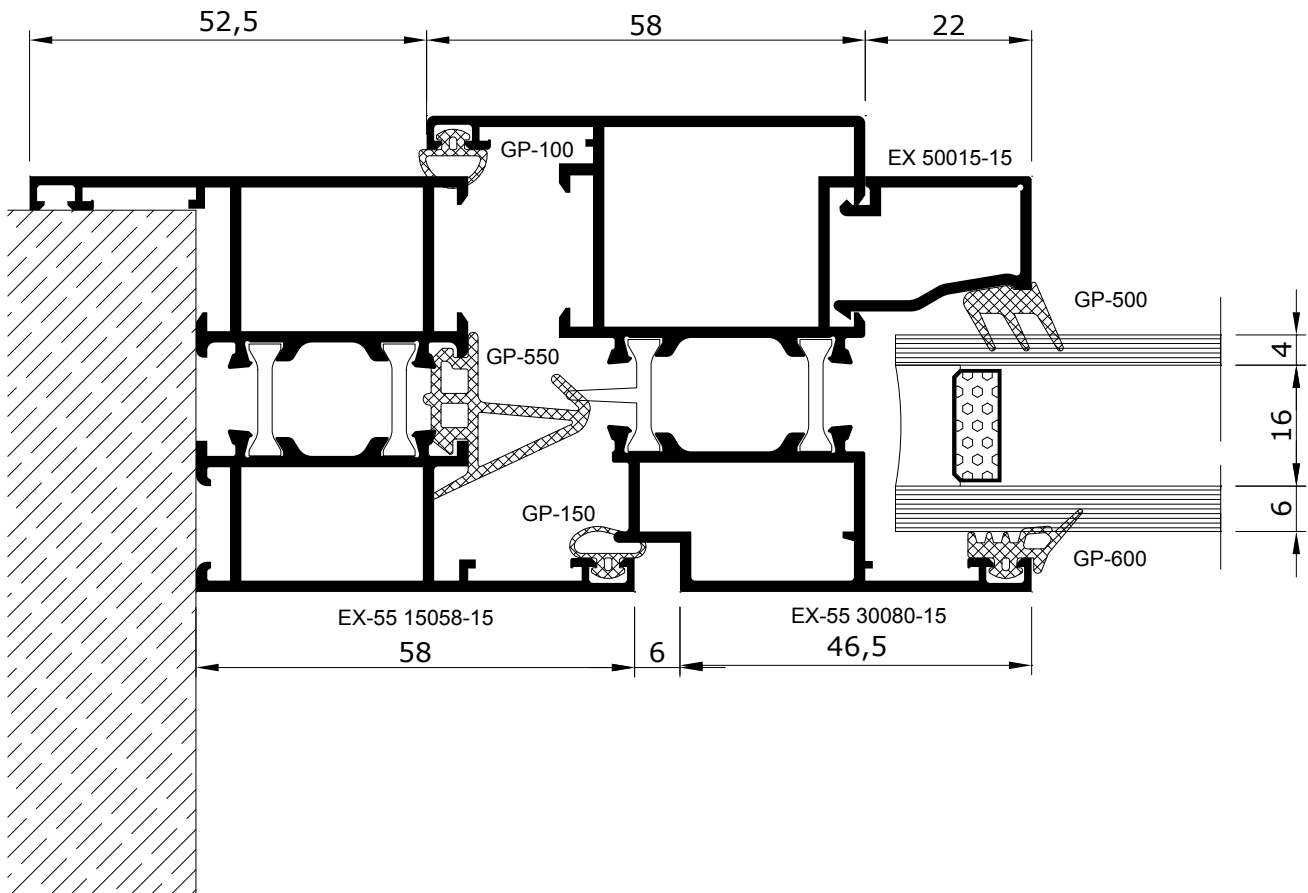
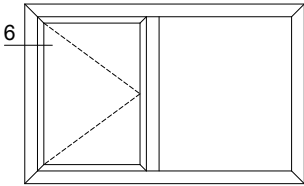

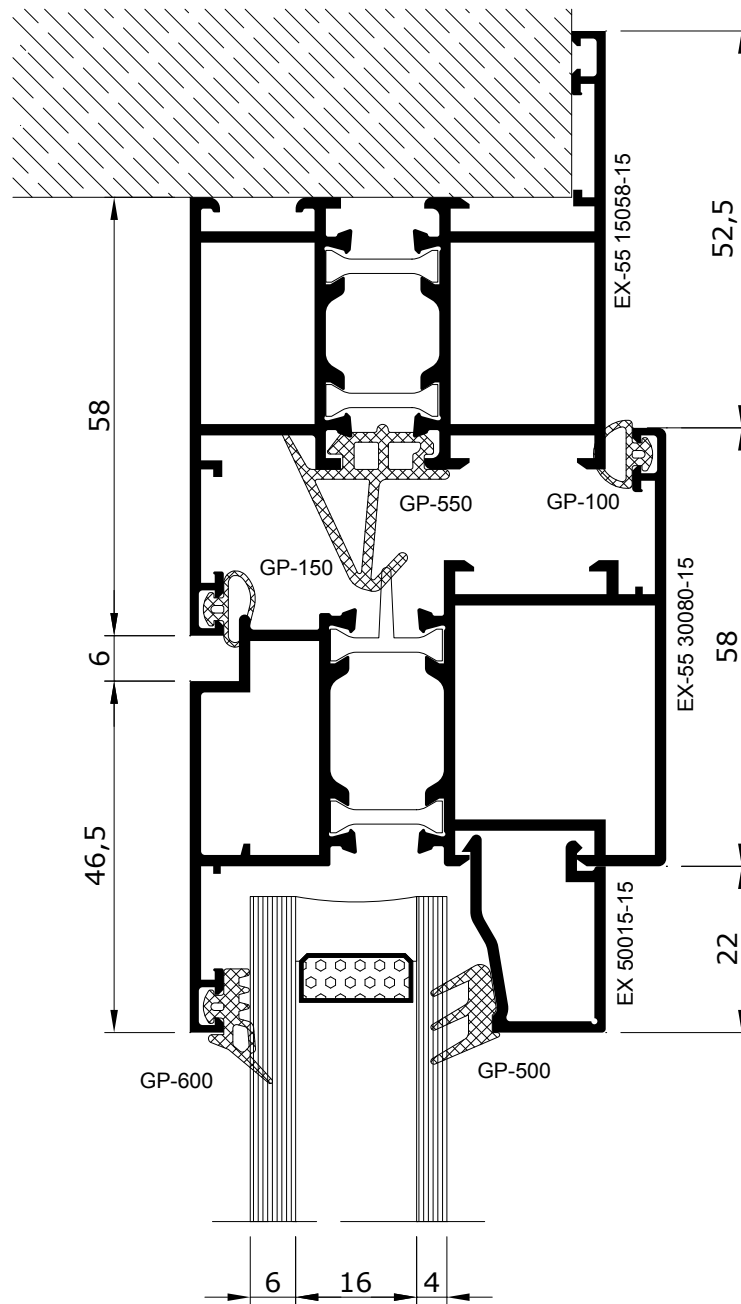
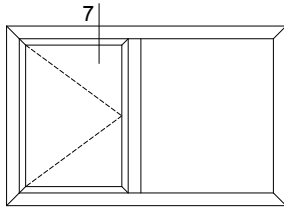

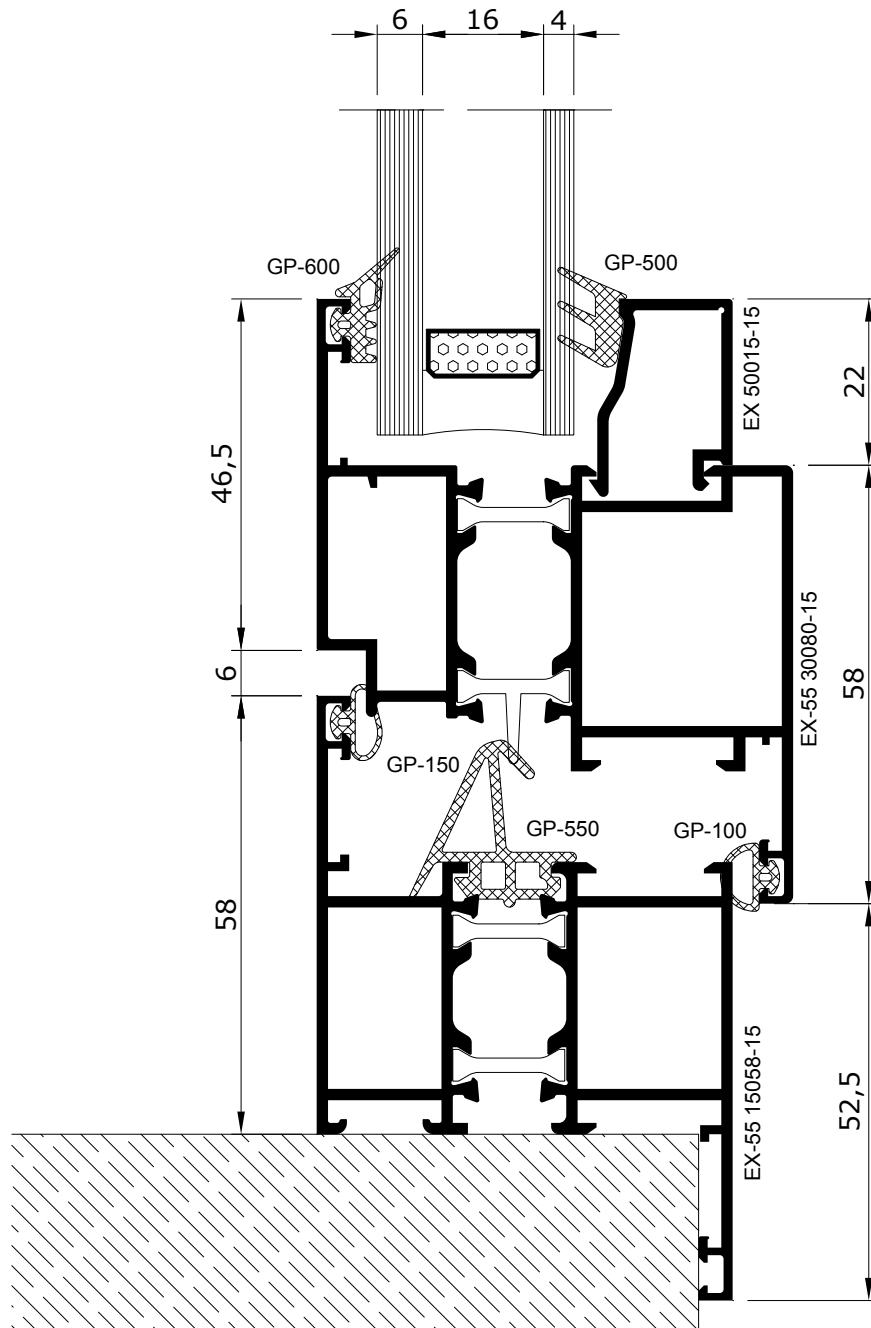
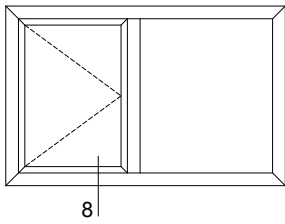

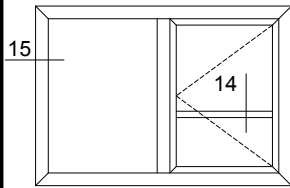

14

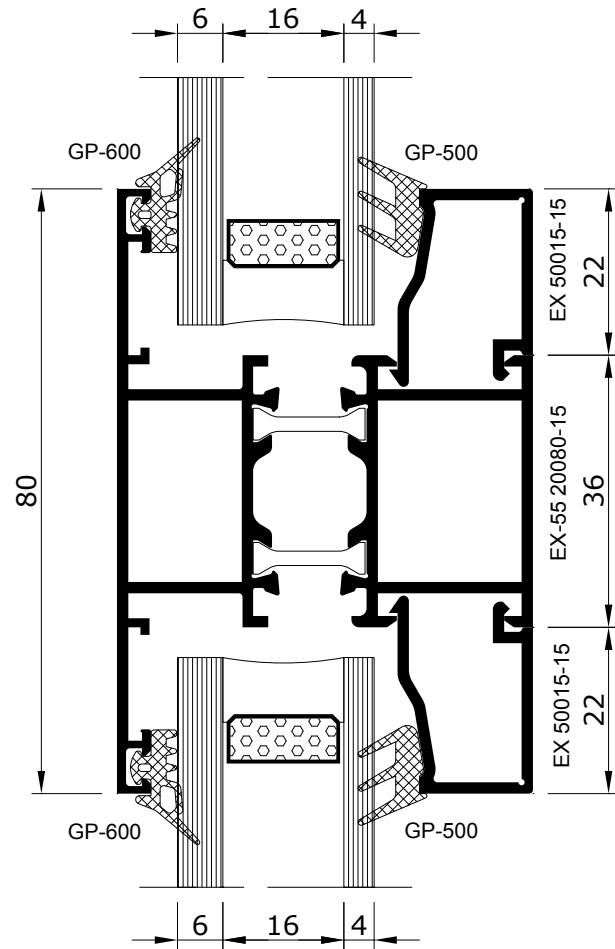

15

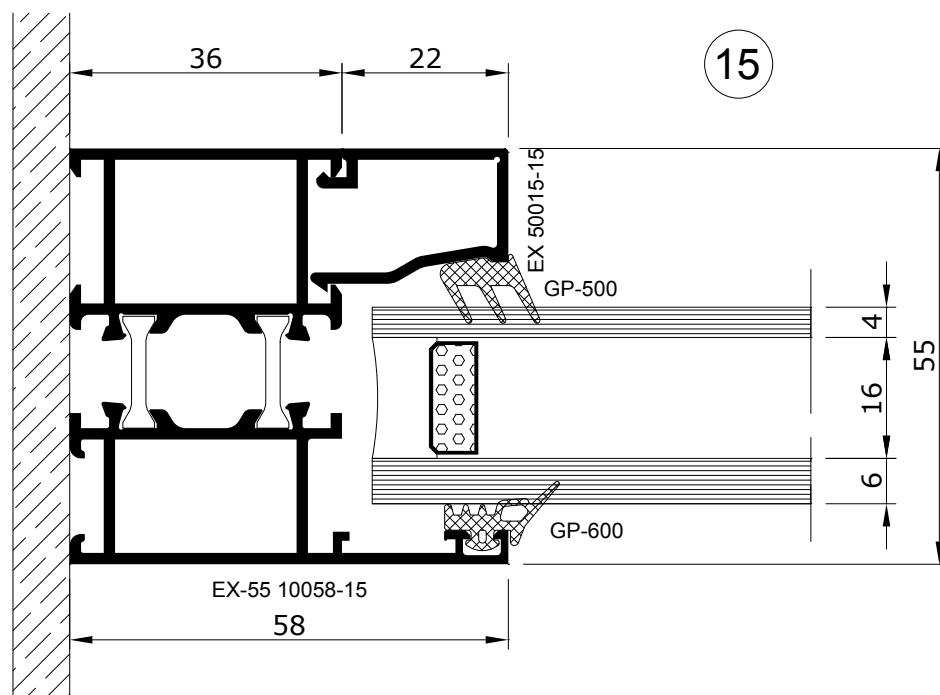

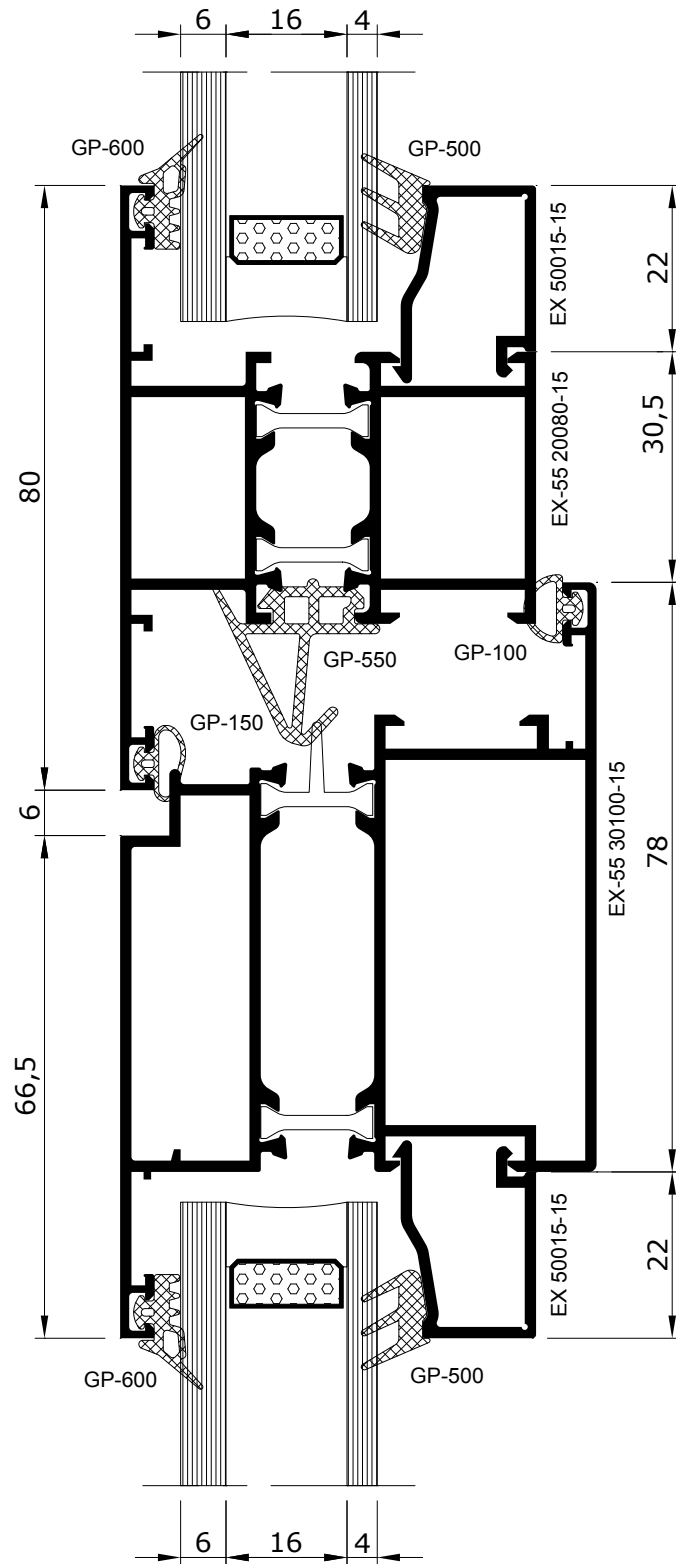
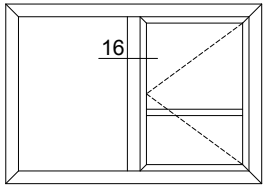

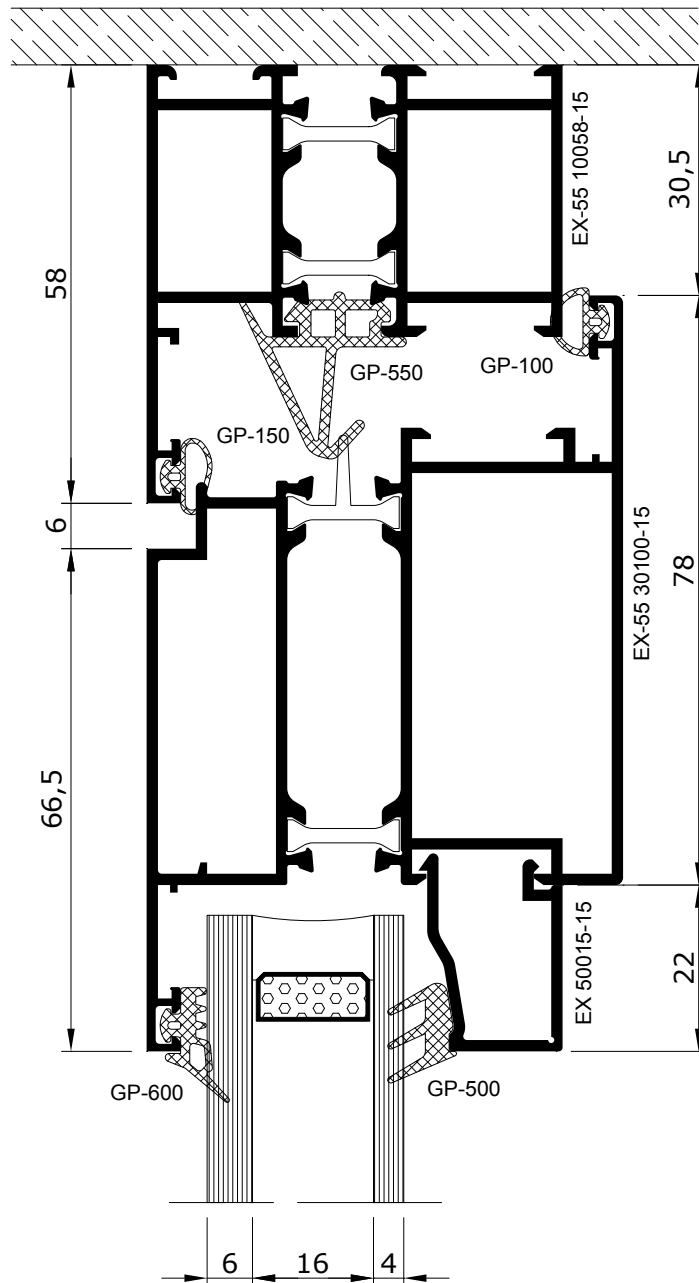
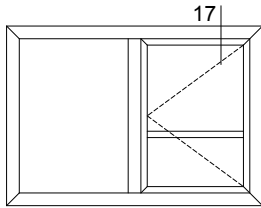

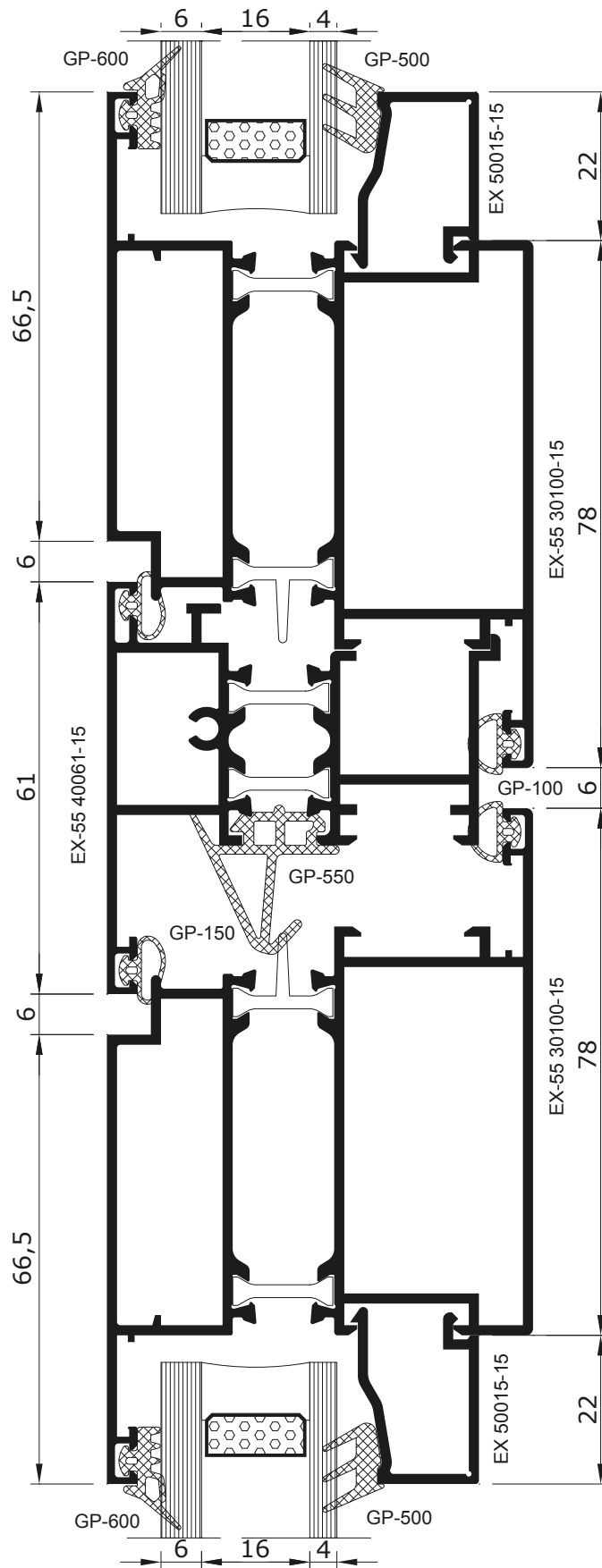
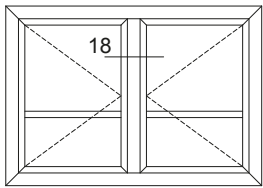

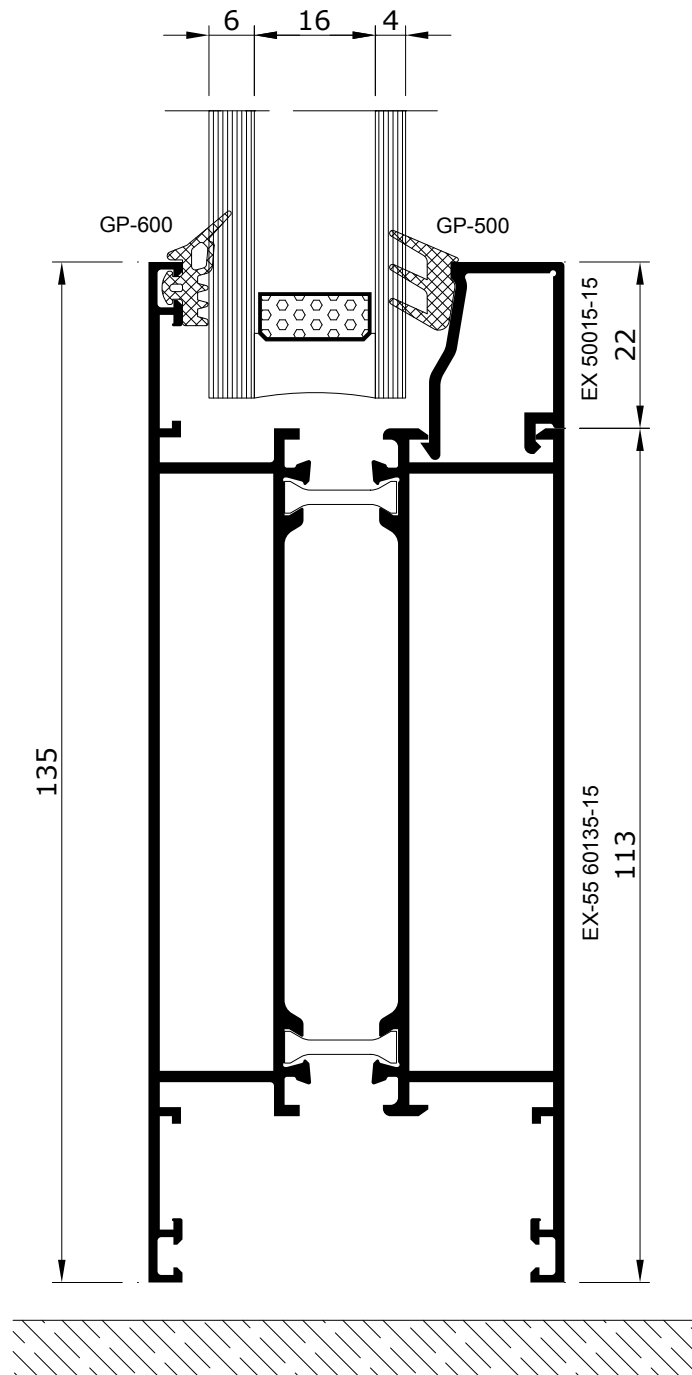
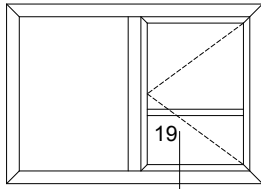

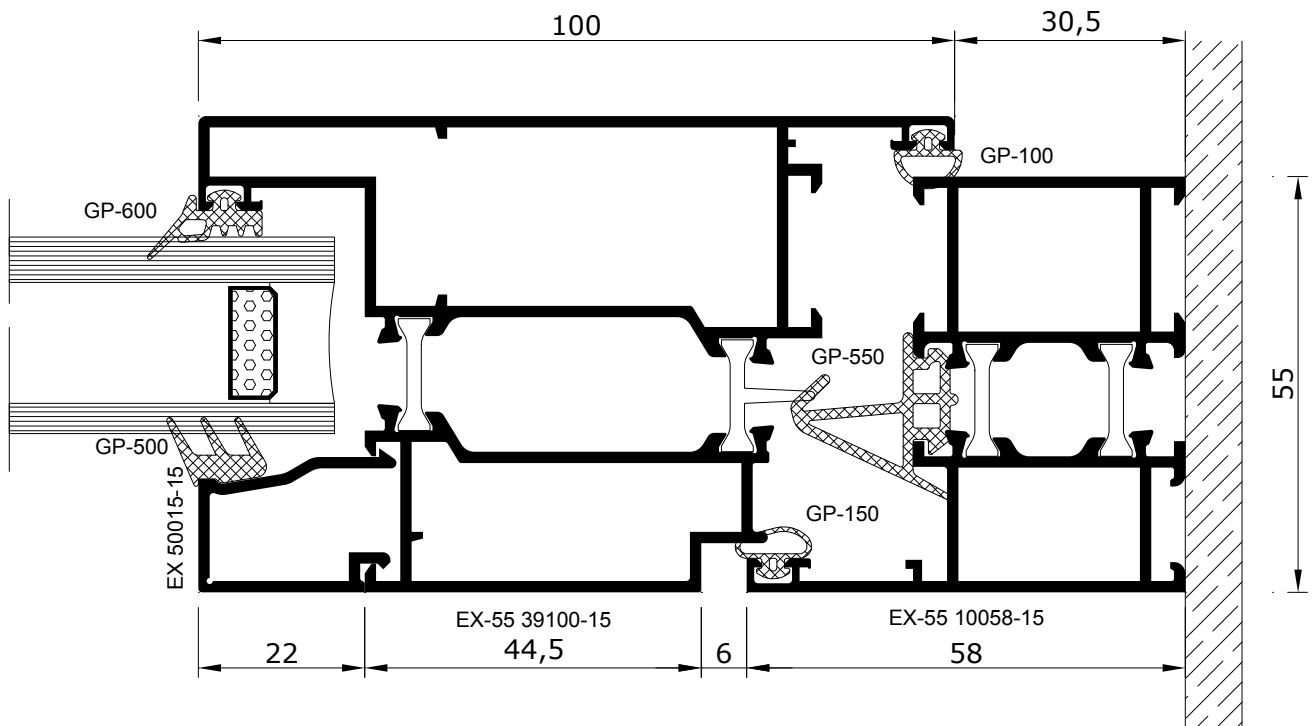
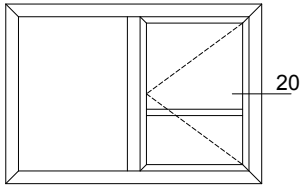

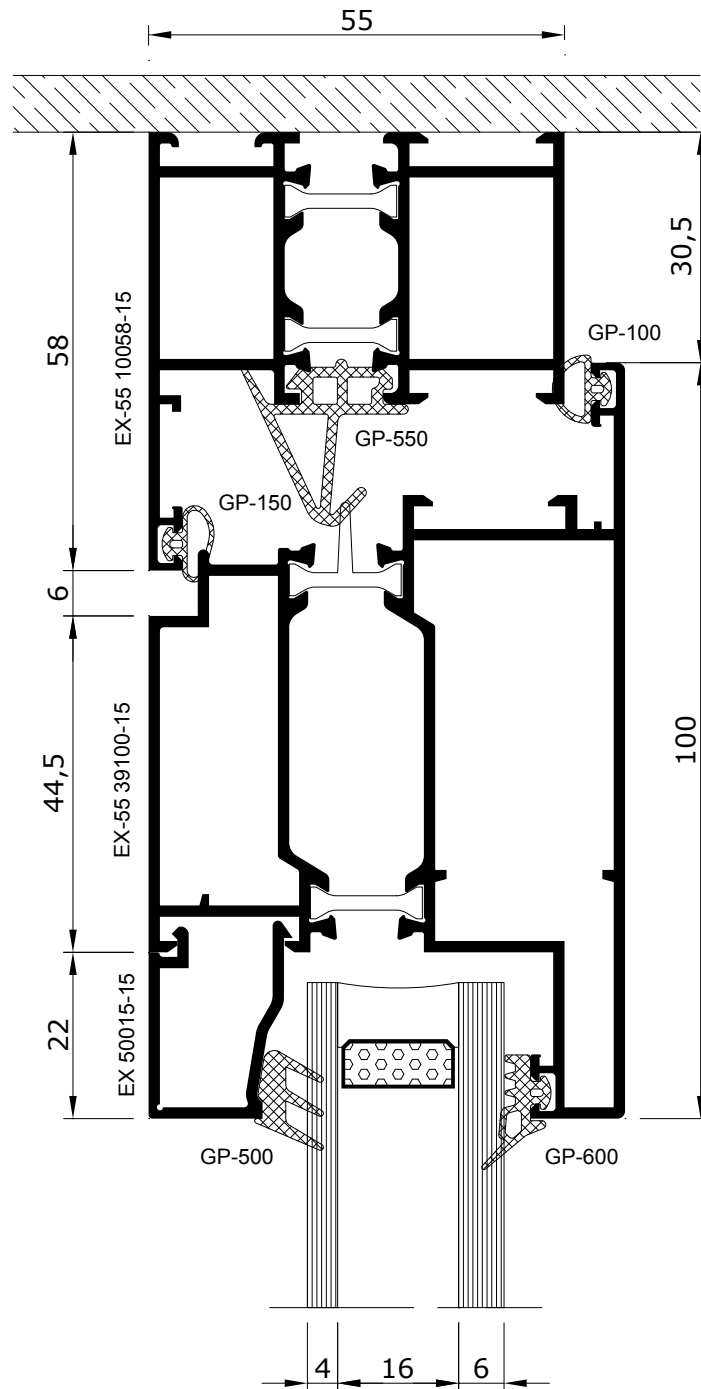
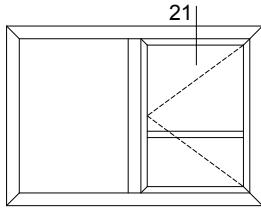

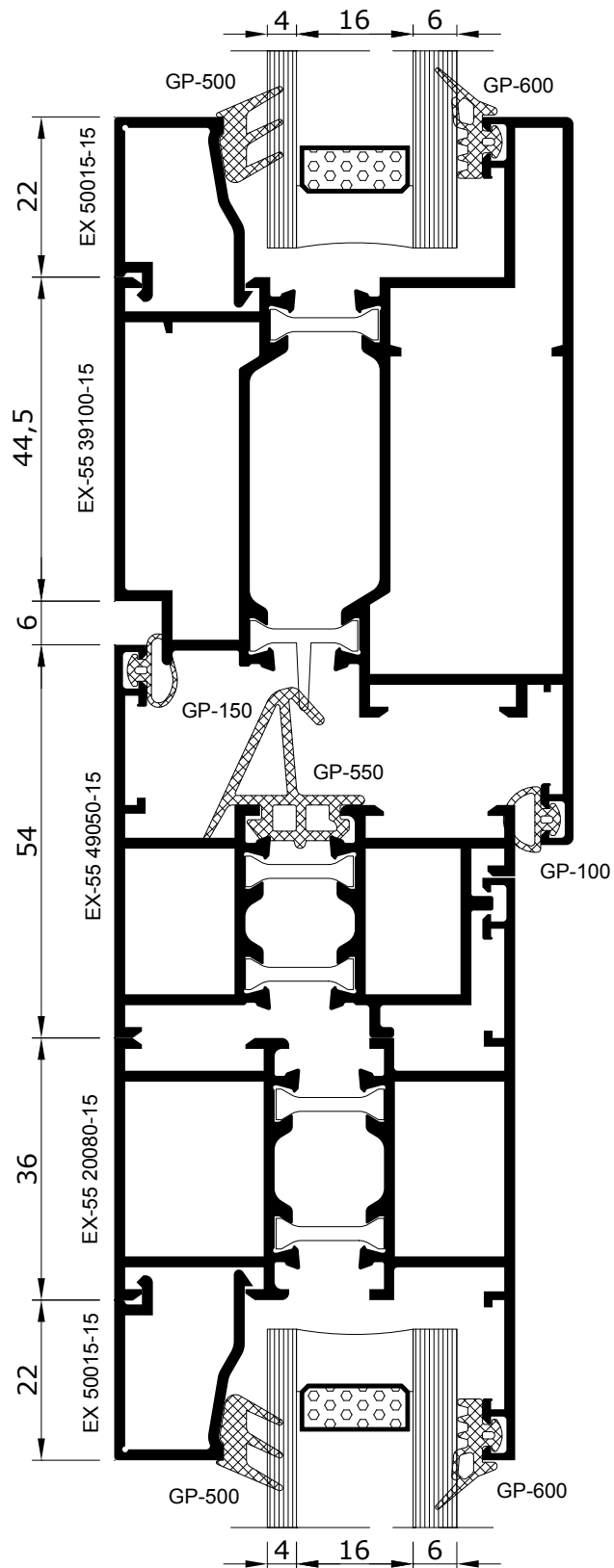
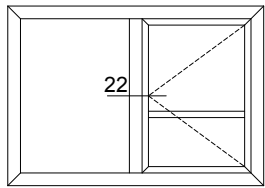

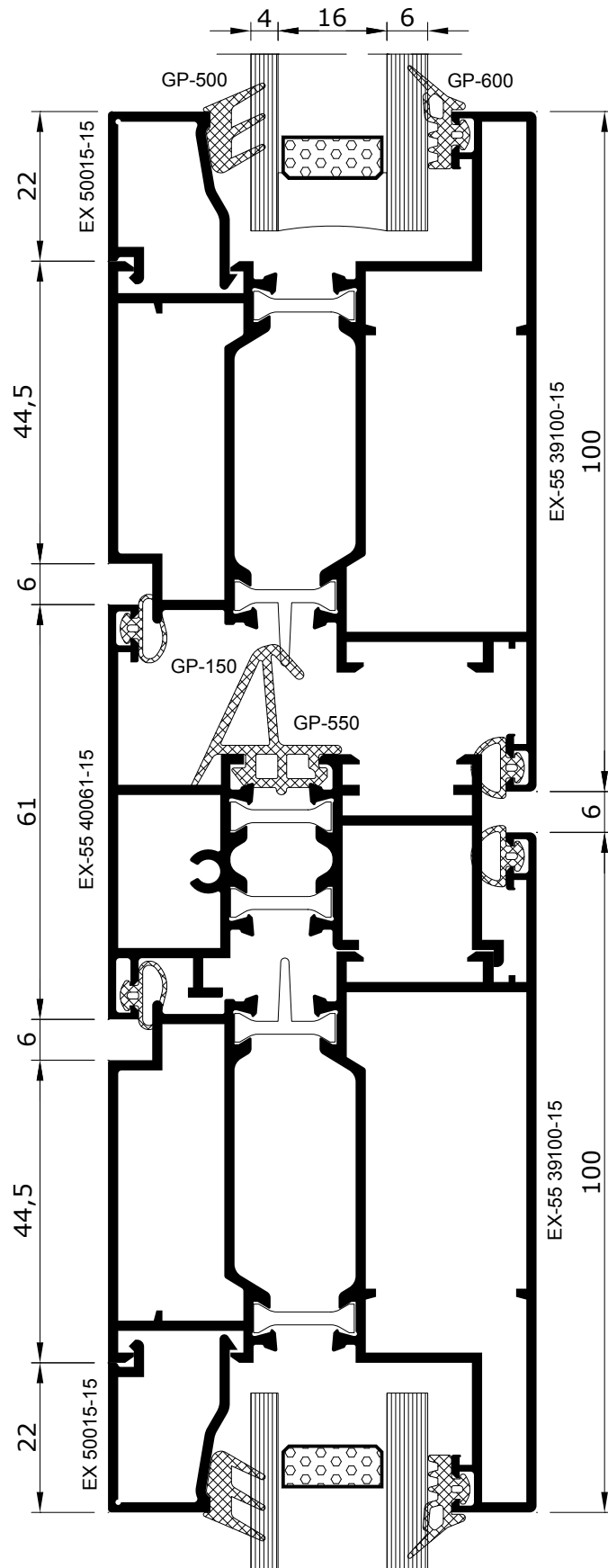
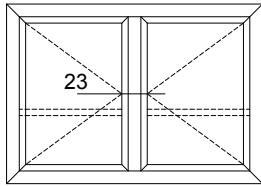

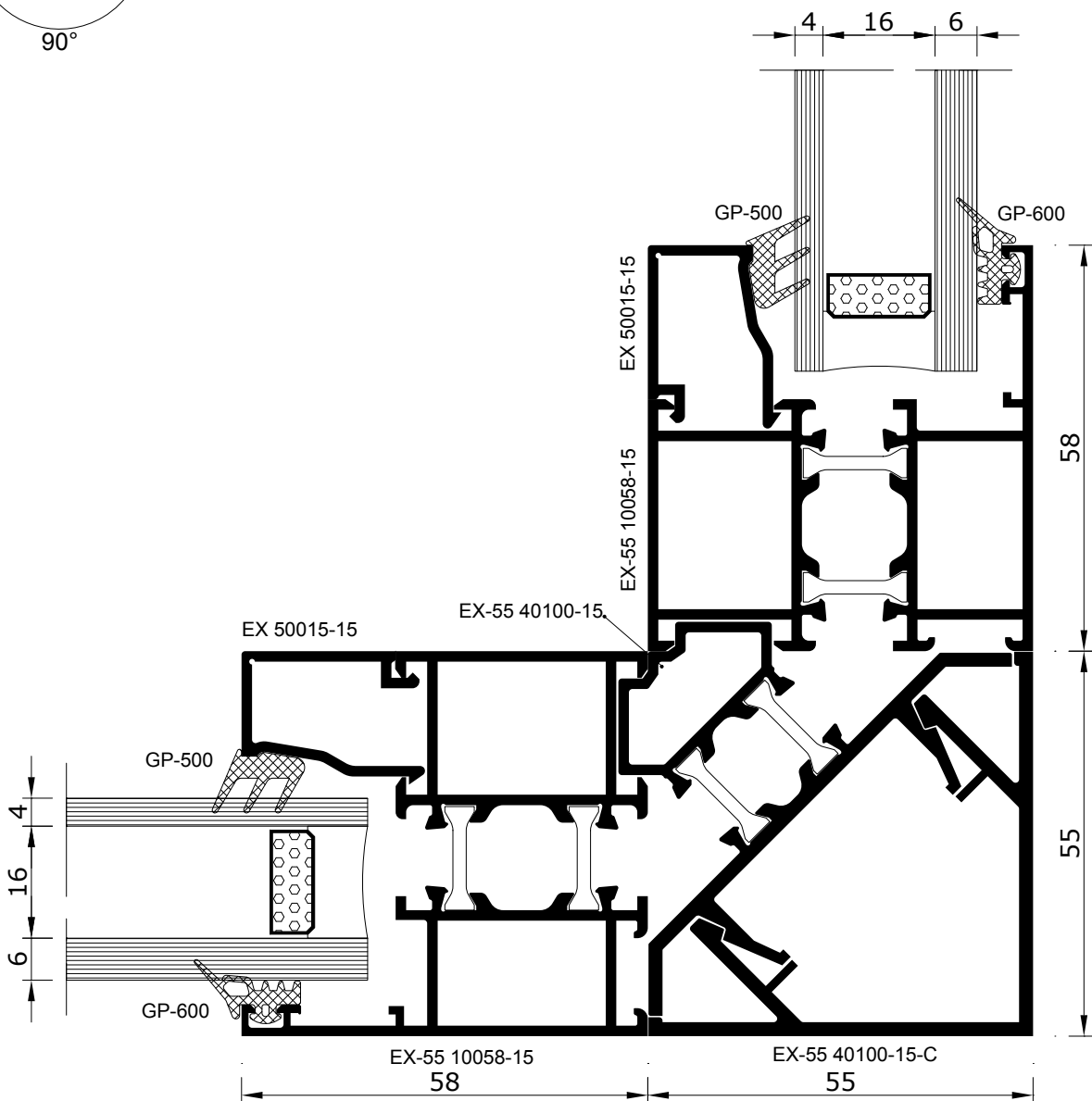
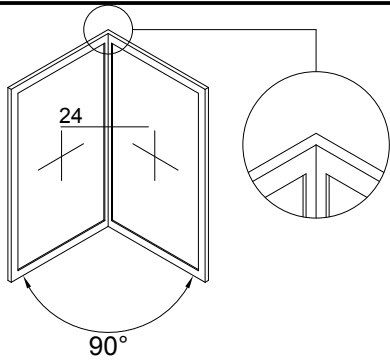

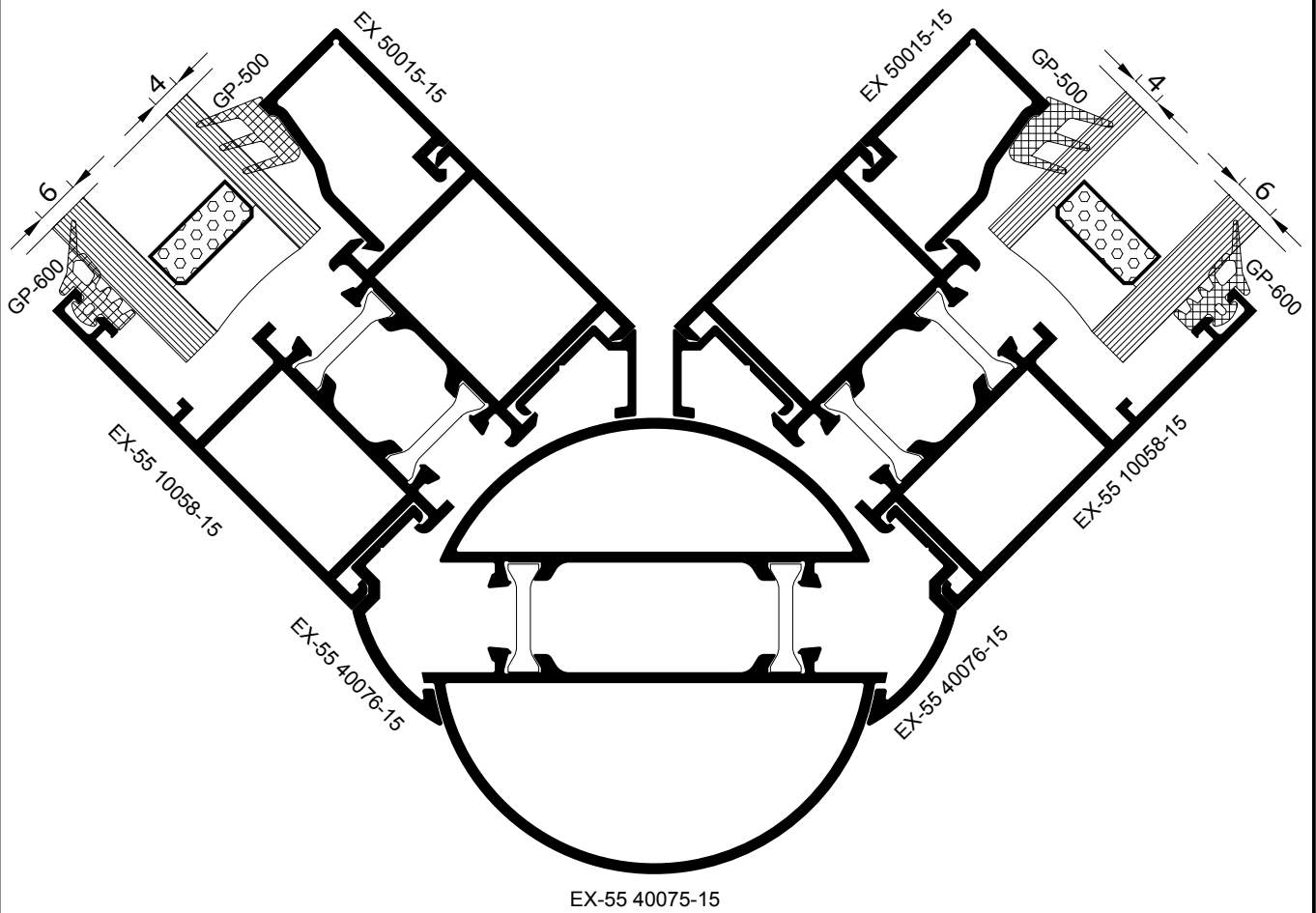
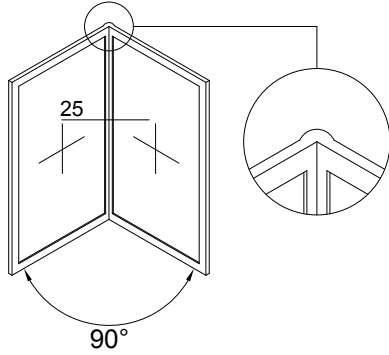

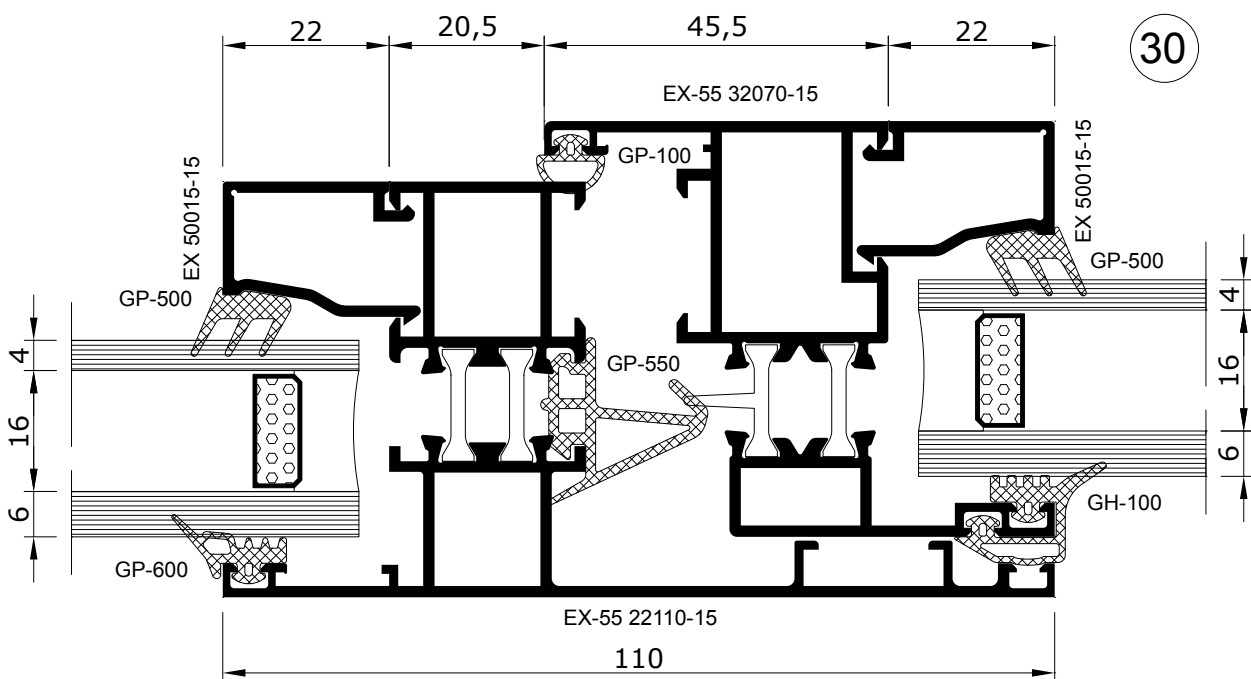
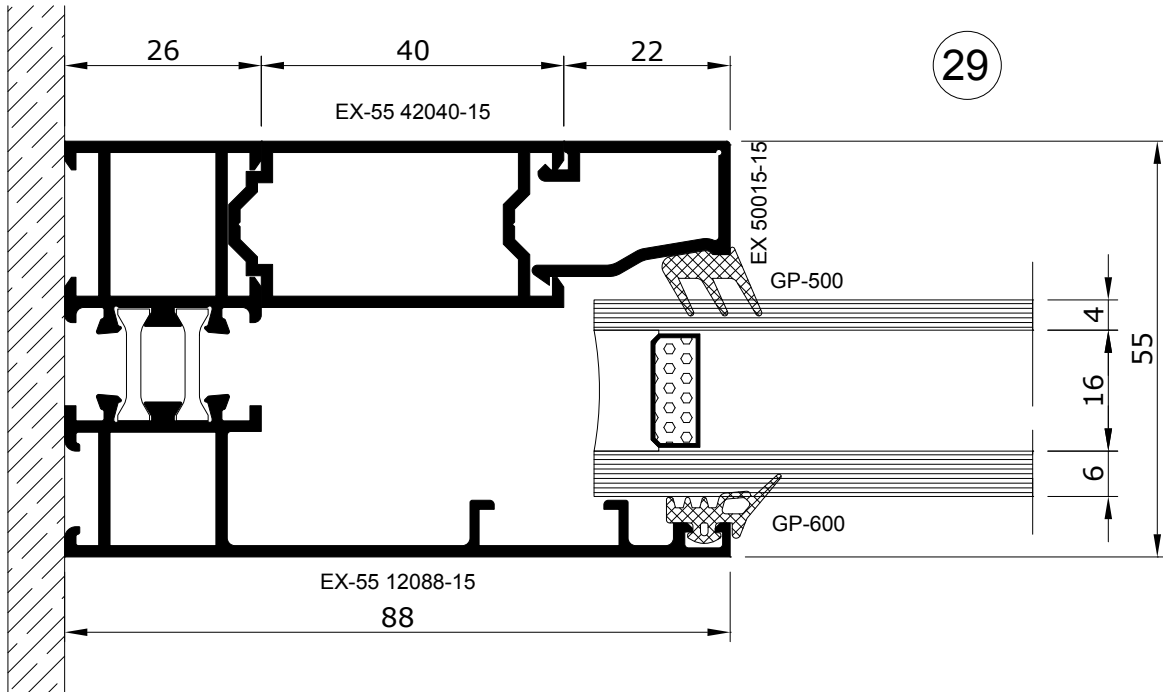
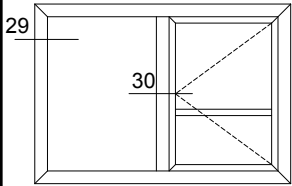

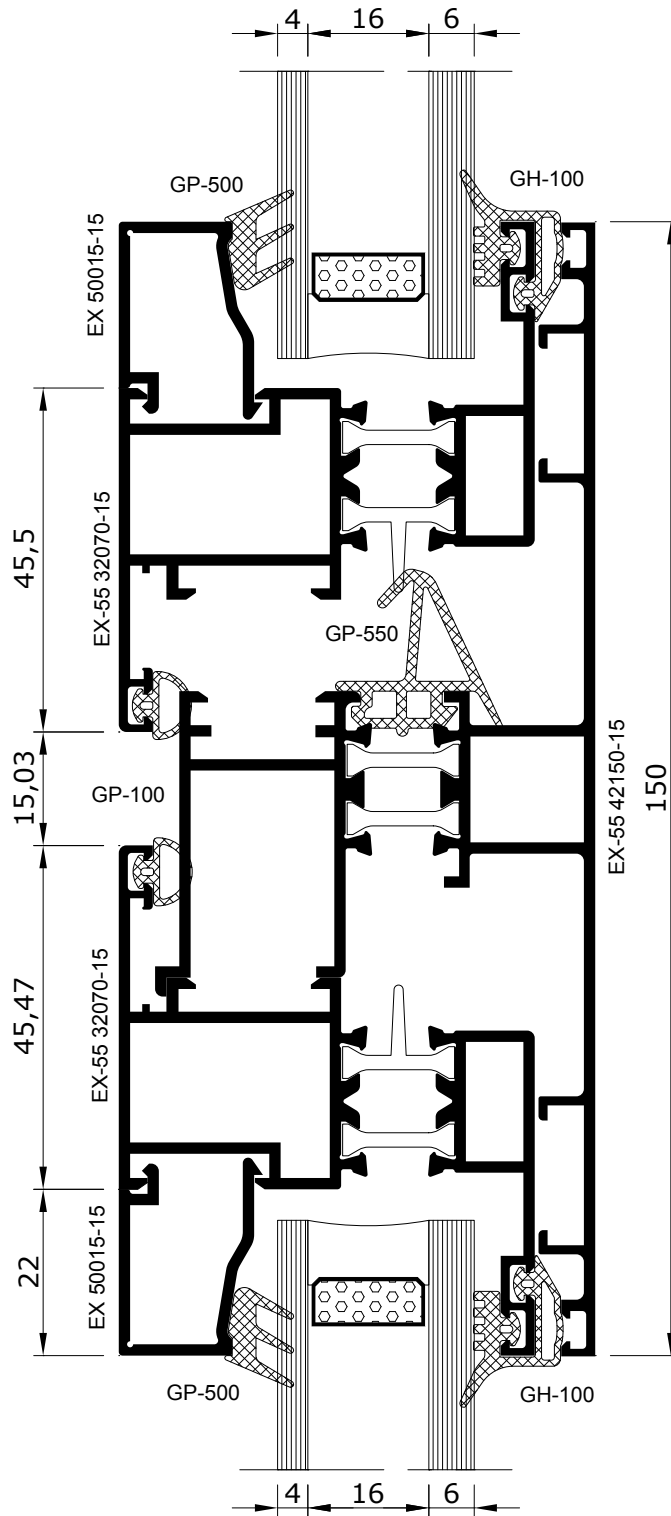
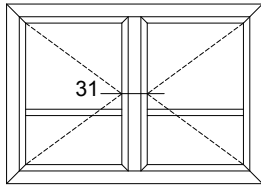

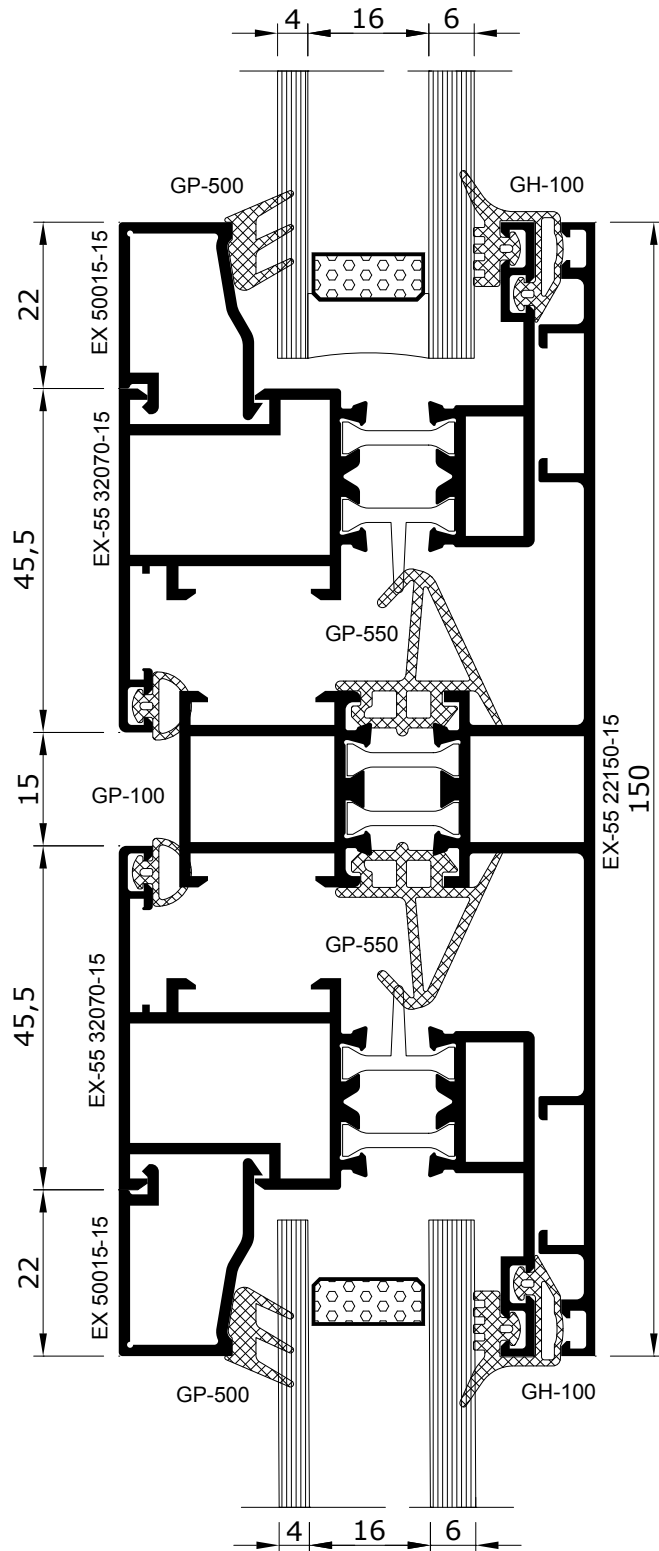
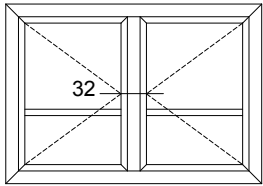

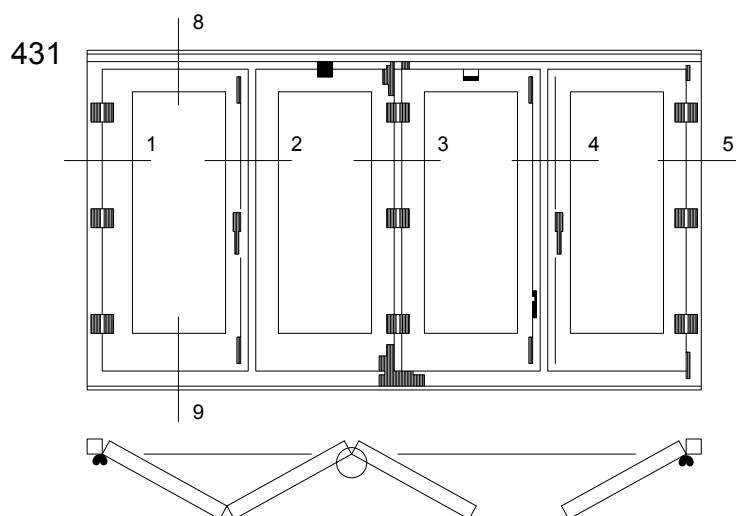
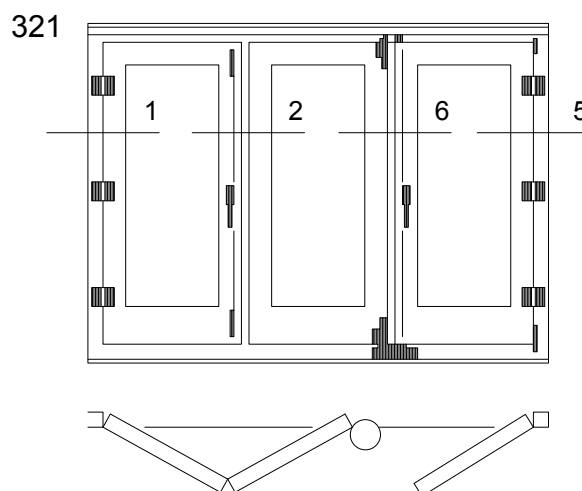
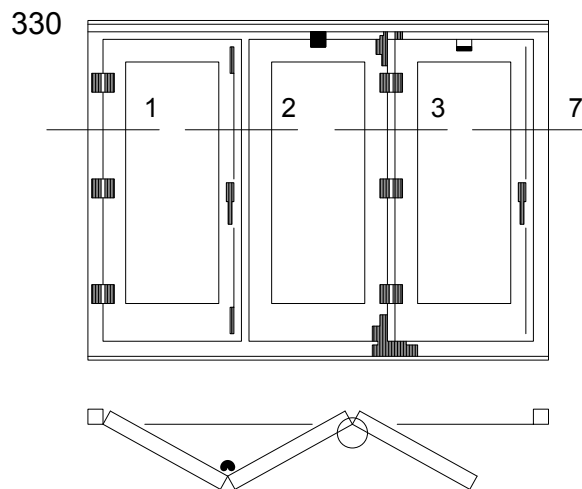

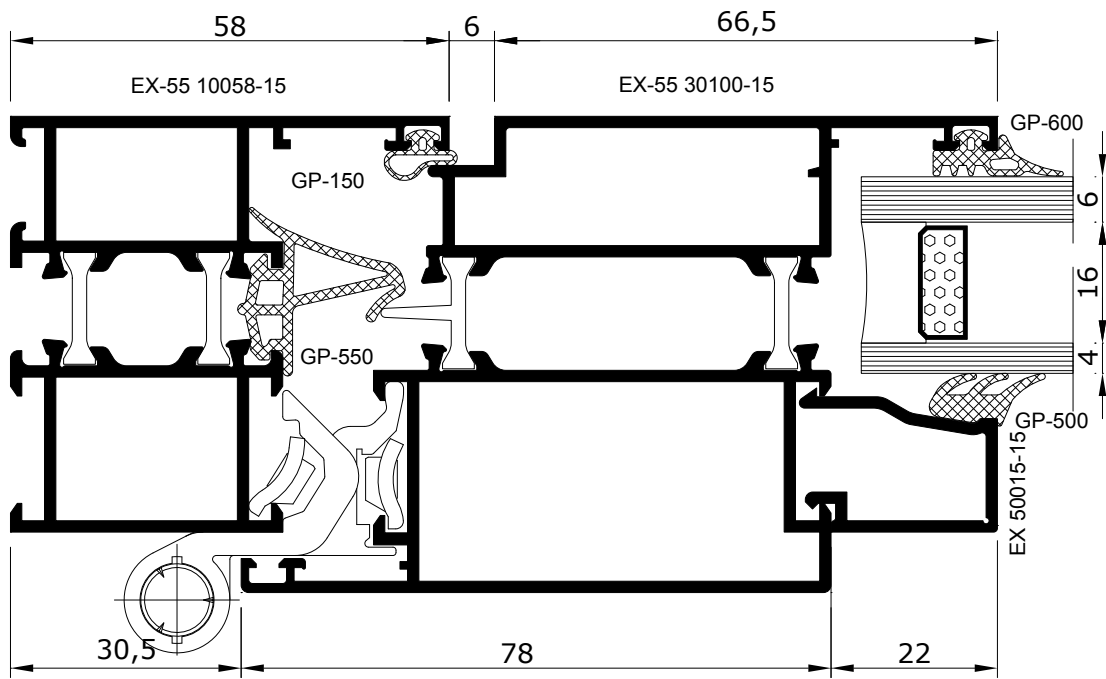

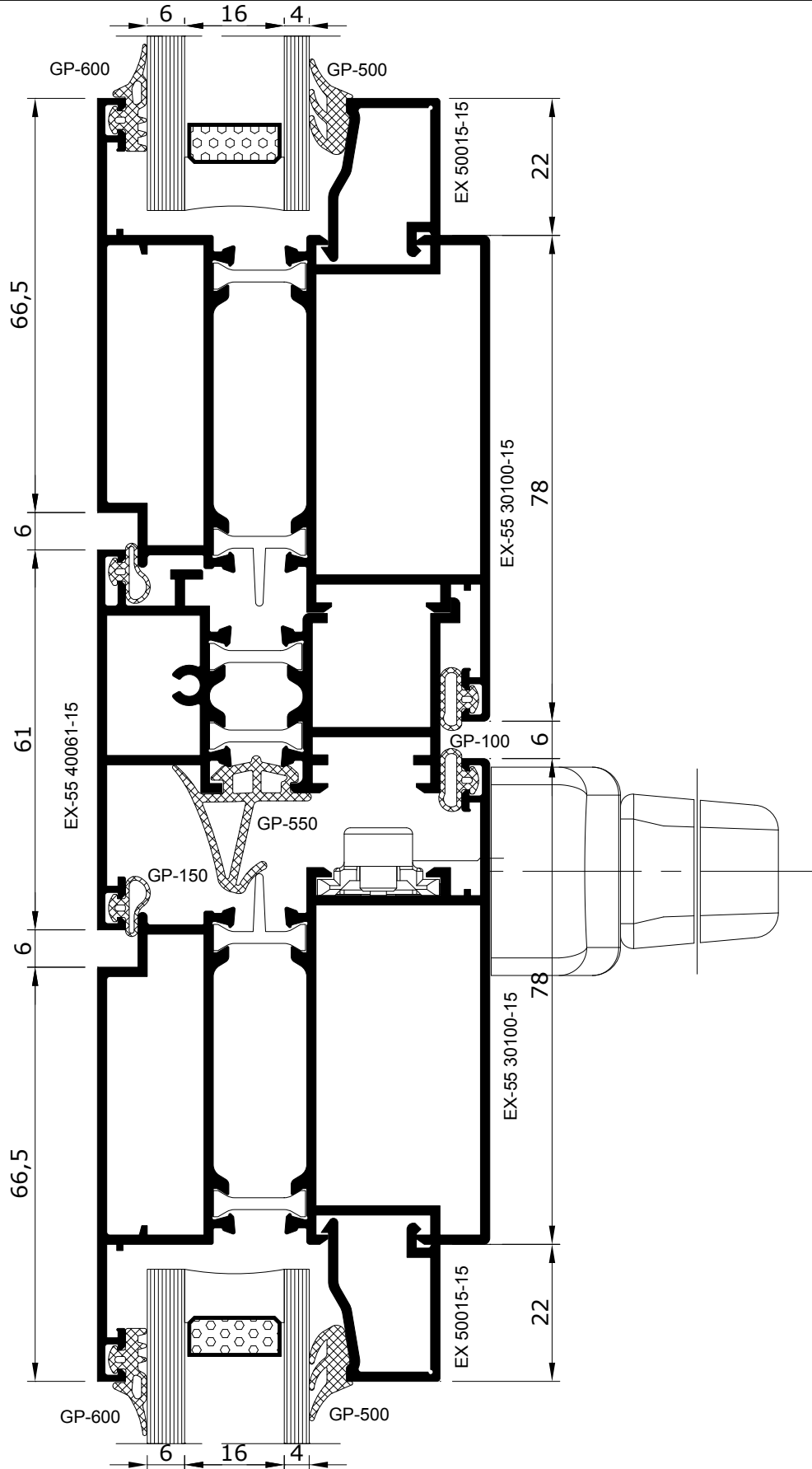

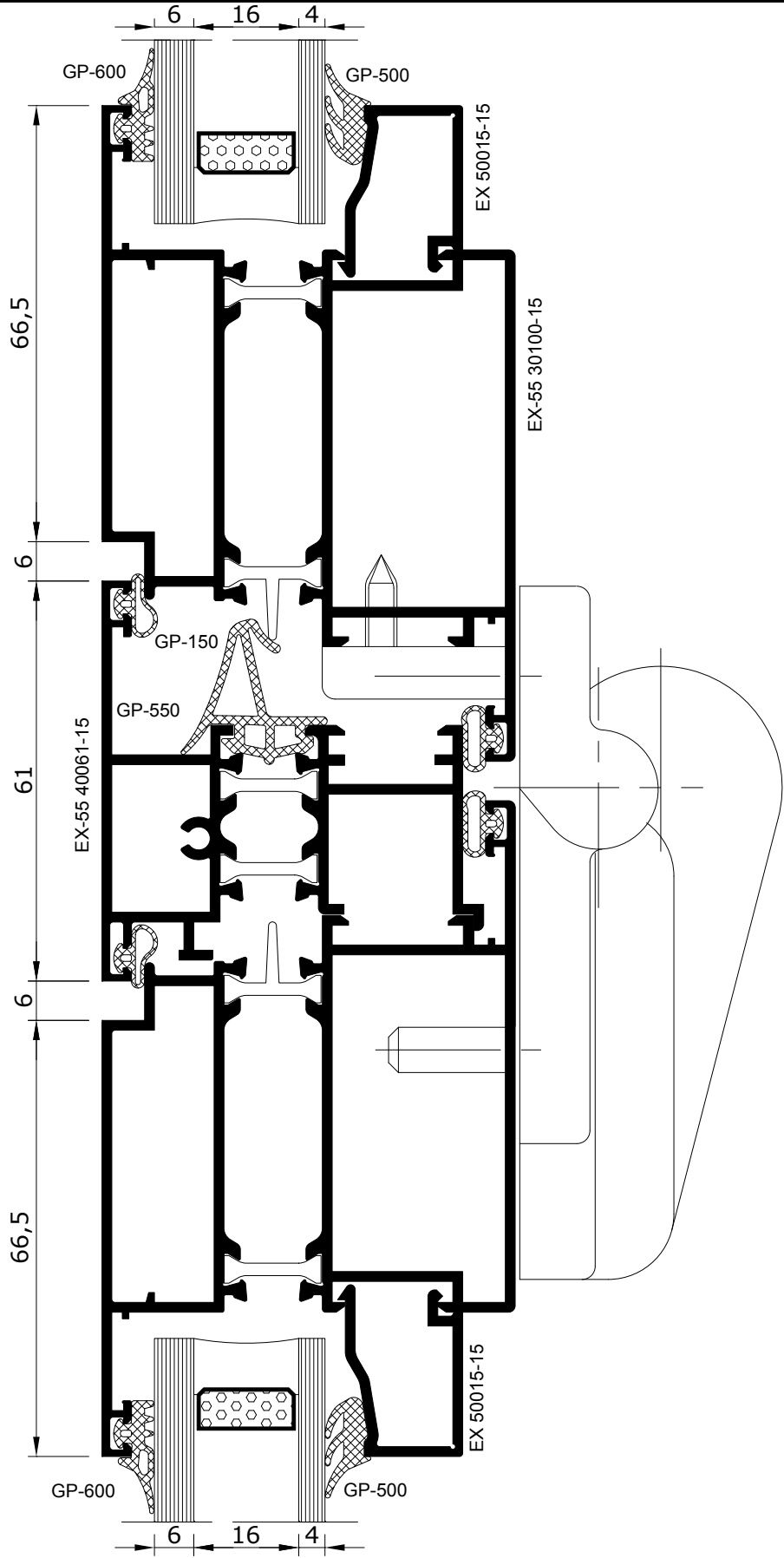

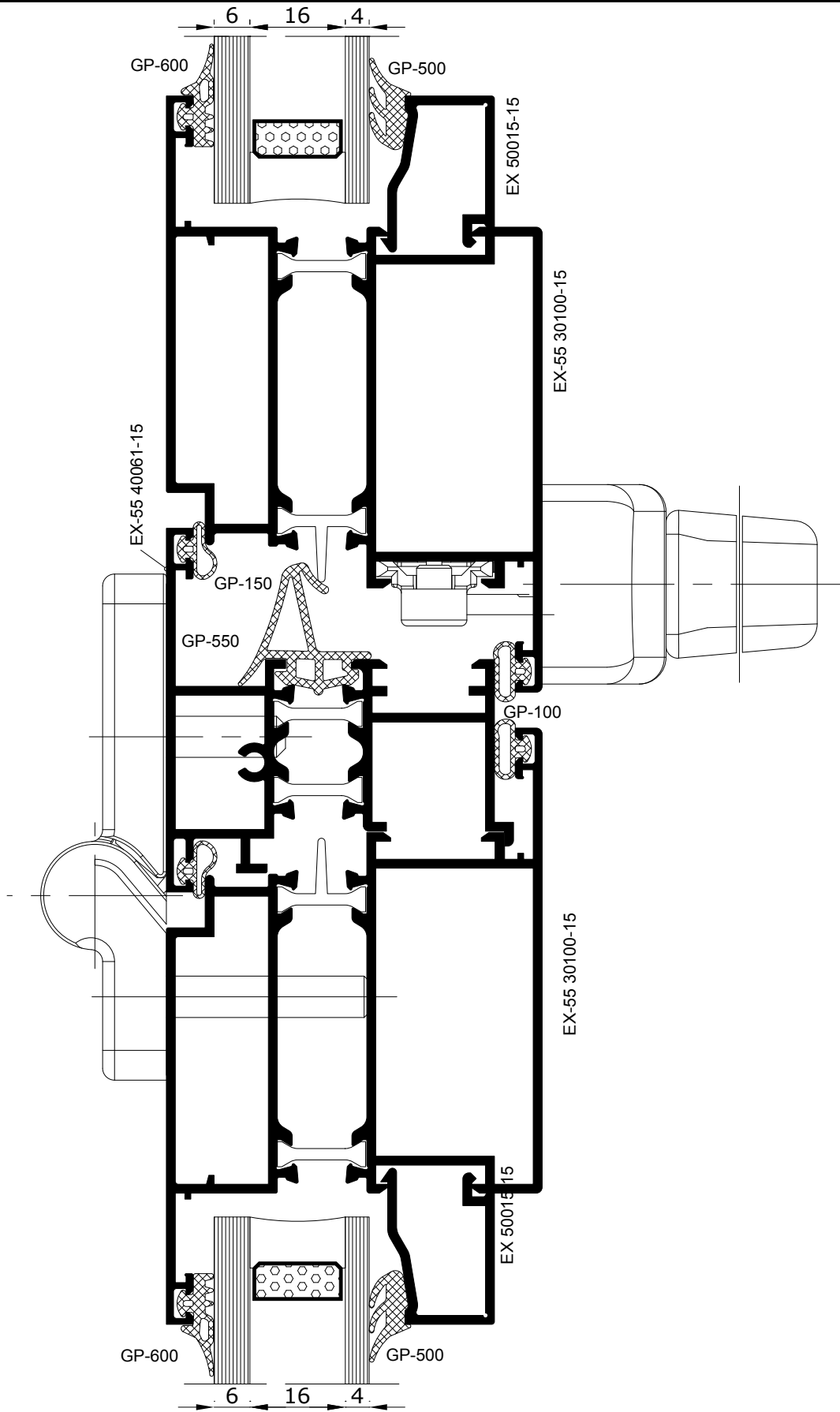

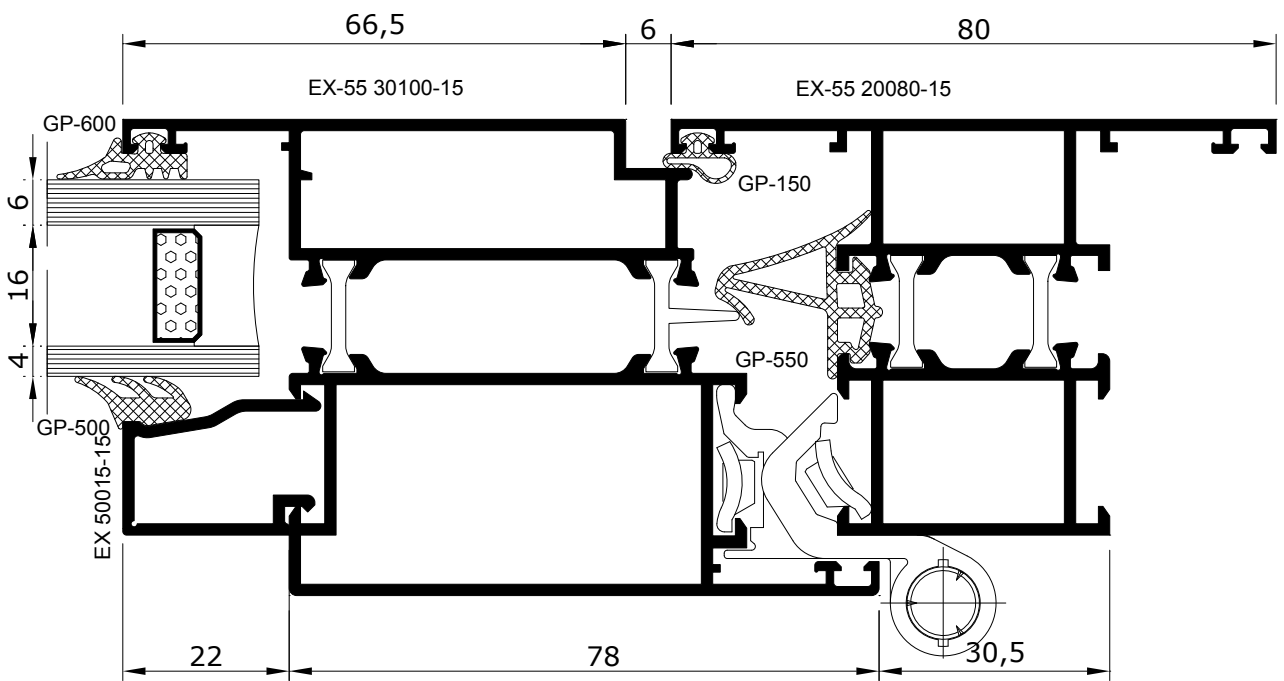

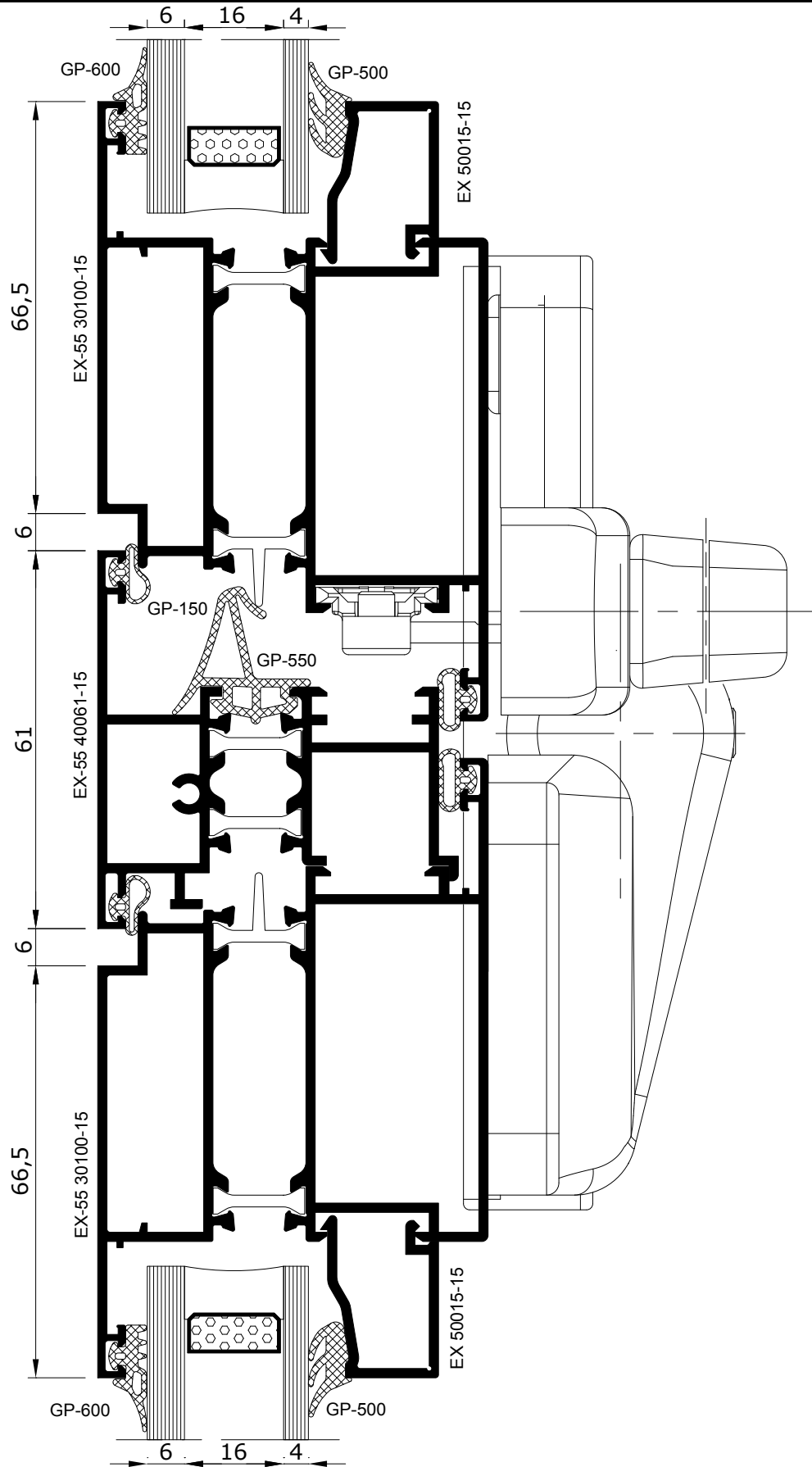

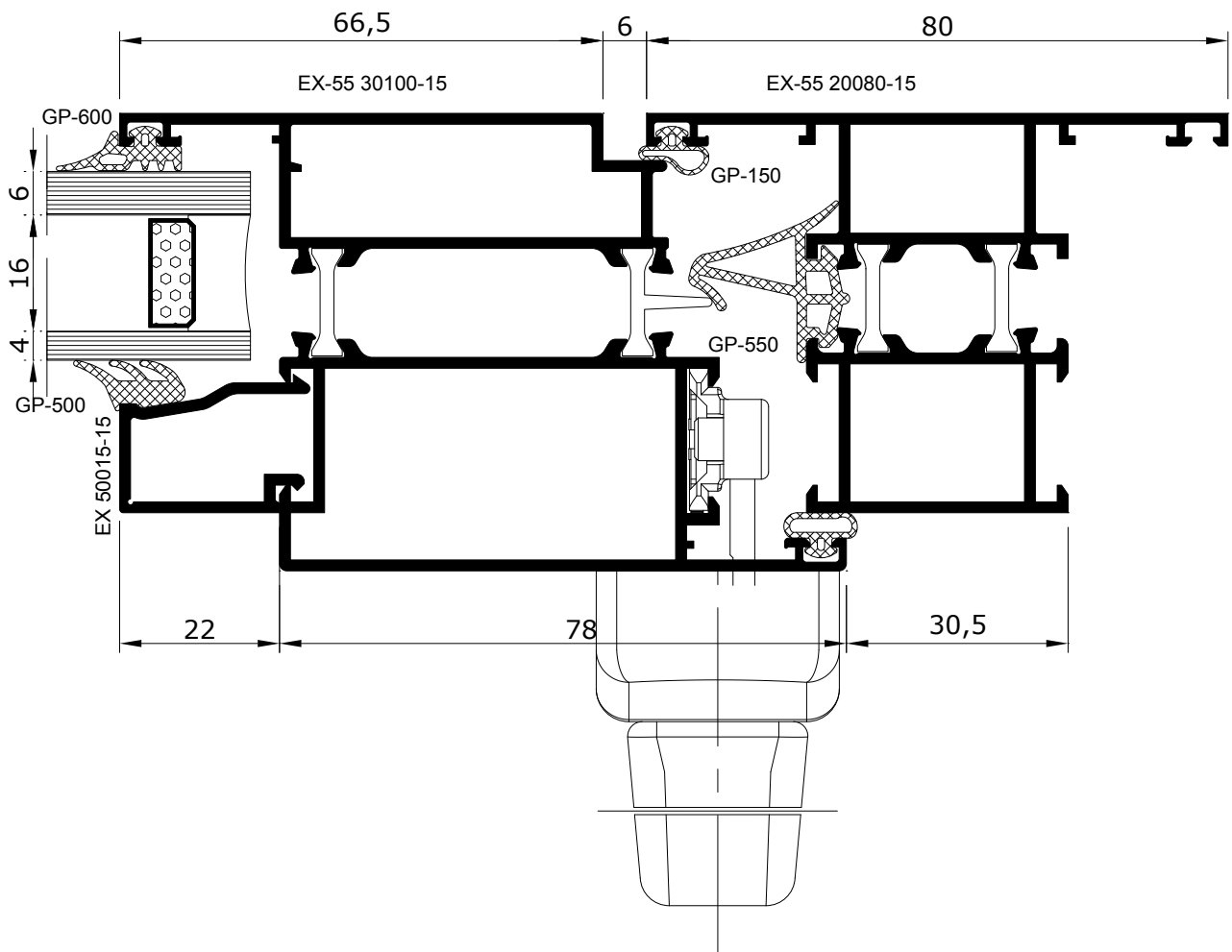

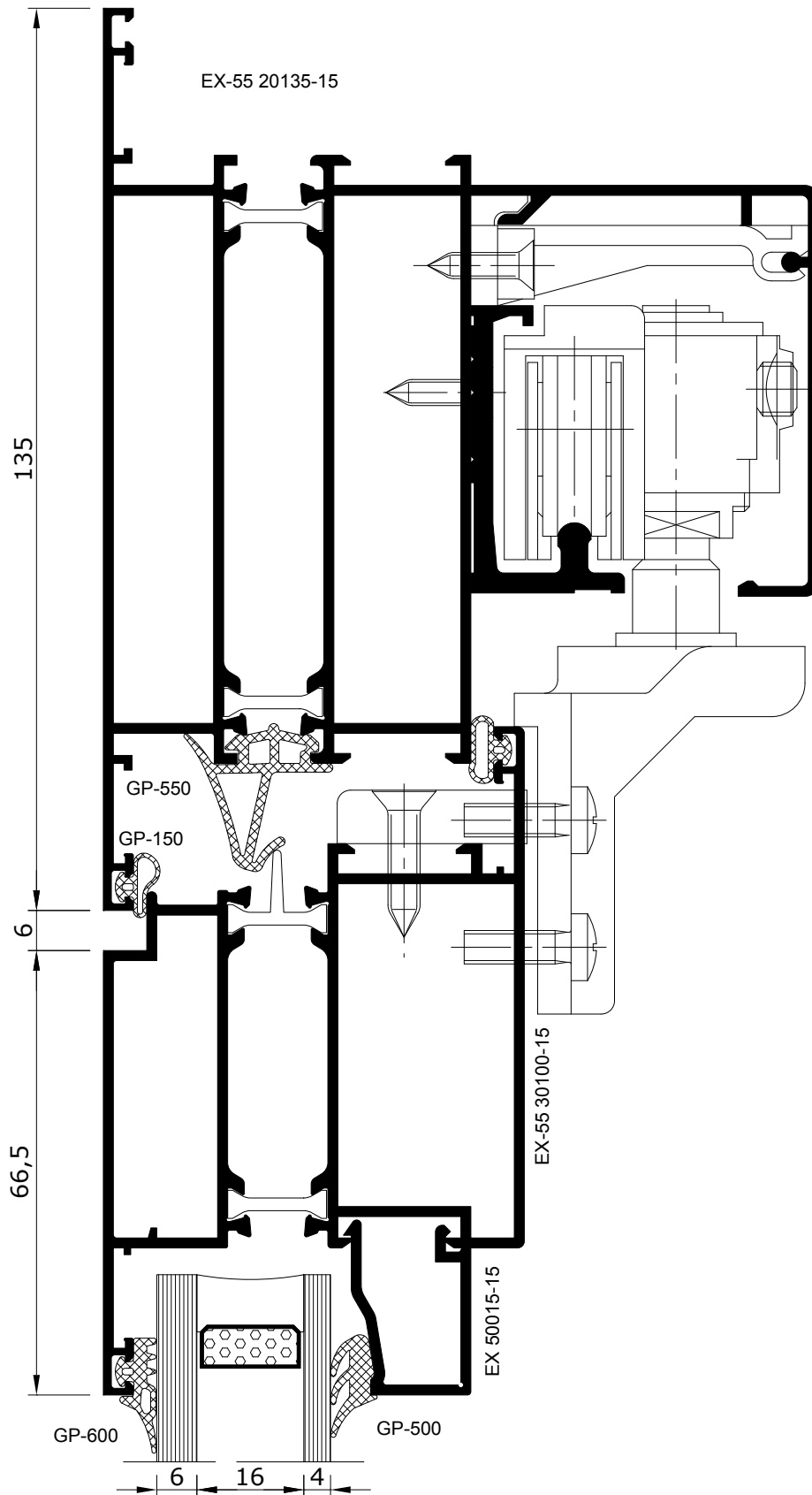

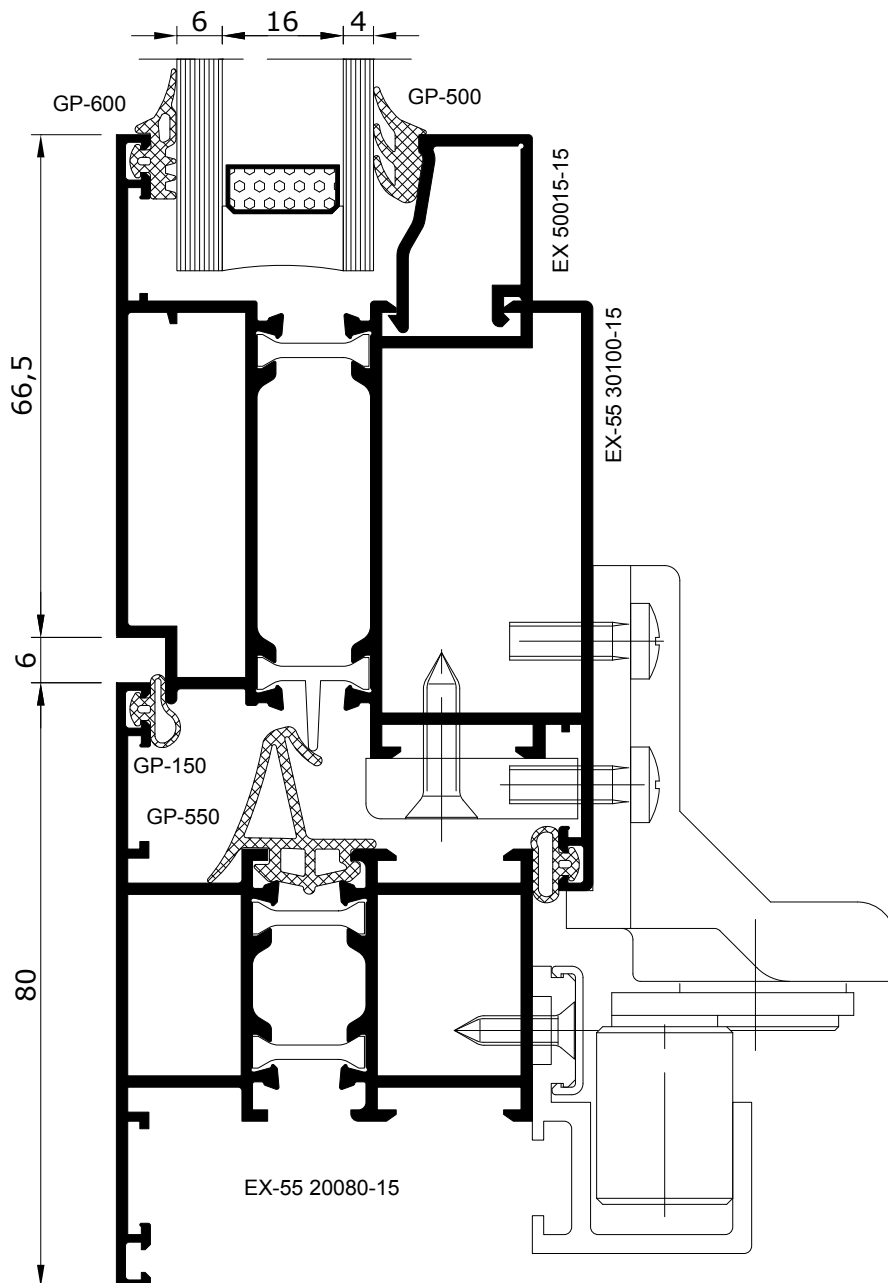

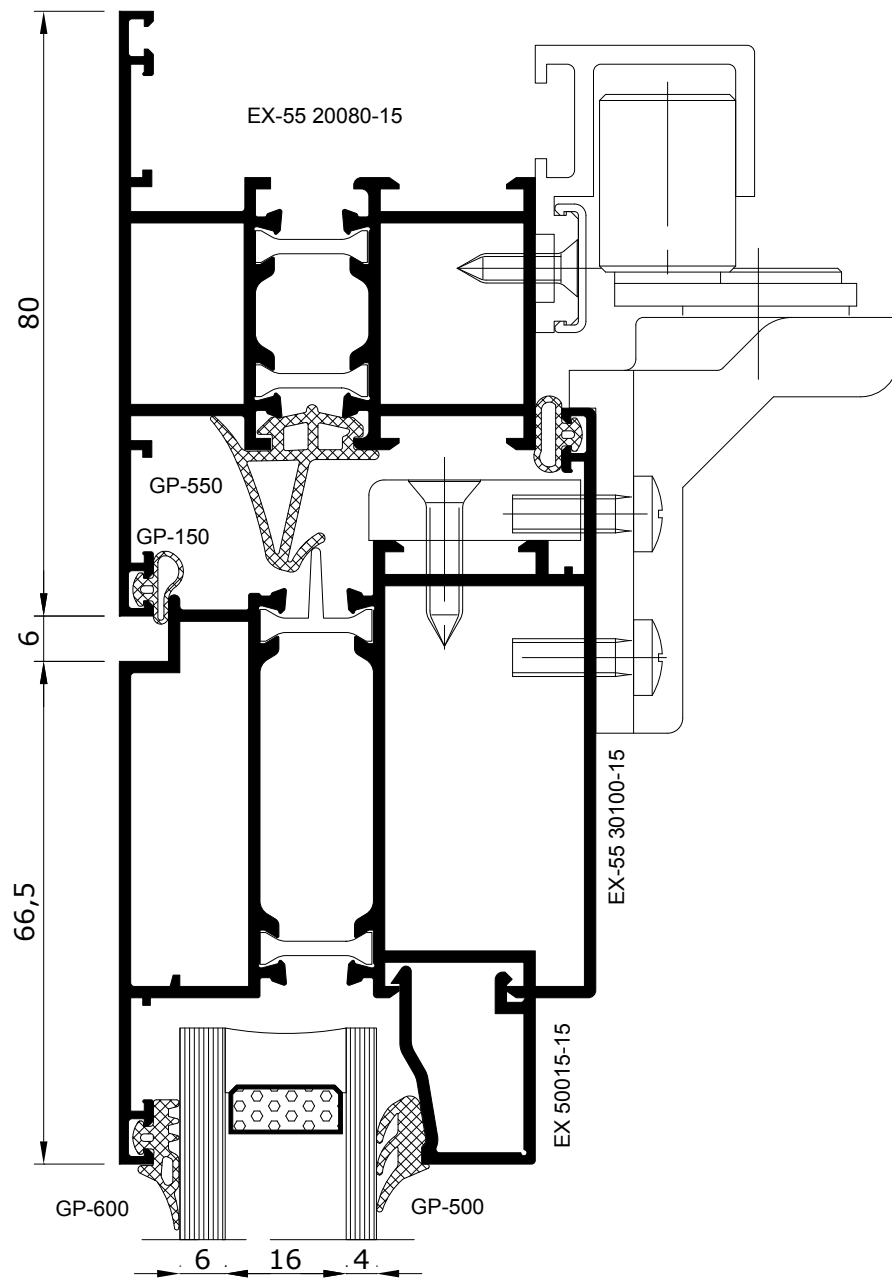

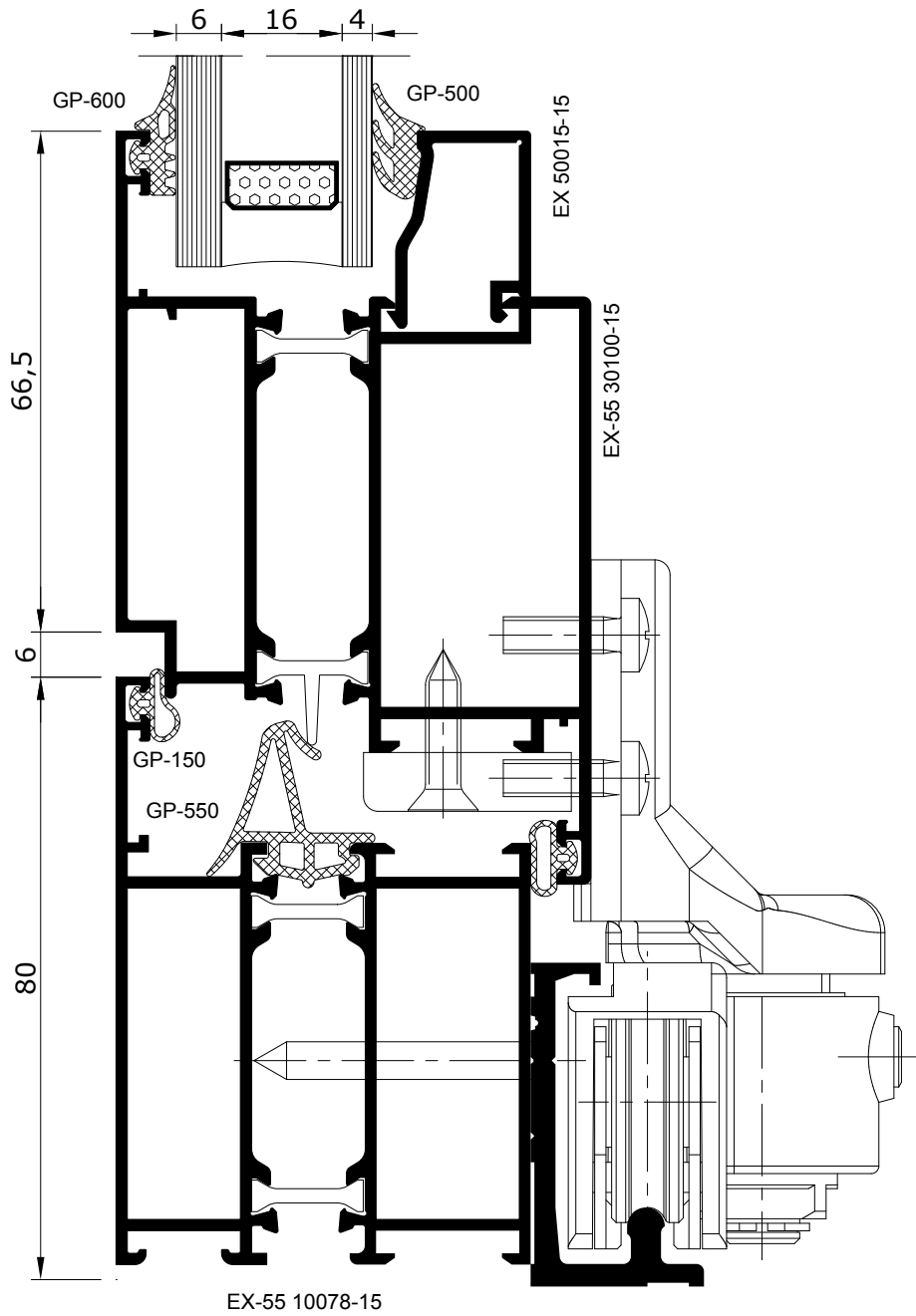



آدرس: زنجان، شهرک صنعتی شماره یک، خیابان پروفیسور ثبوتی، روبروی خیابان آذر جنوبی
تلفن: ۴ - ۳۳۲۲ ۱۲۶۳ - ۰۲۴
نمبر: ۱۲۶۵ - ۳۳۲۲ - ۰۲۴

Add: Professor sabouti St., No.1 Industrial Zone, Zanjan, iran

Phone: +9824 3222 1263 - 4

Fax: +9824 3222 1265

www.exalaluminium.com

info@exalaluminium.com