

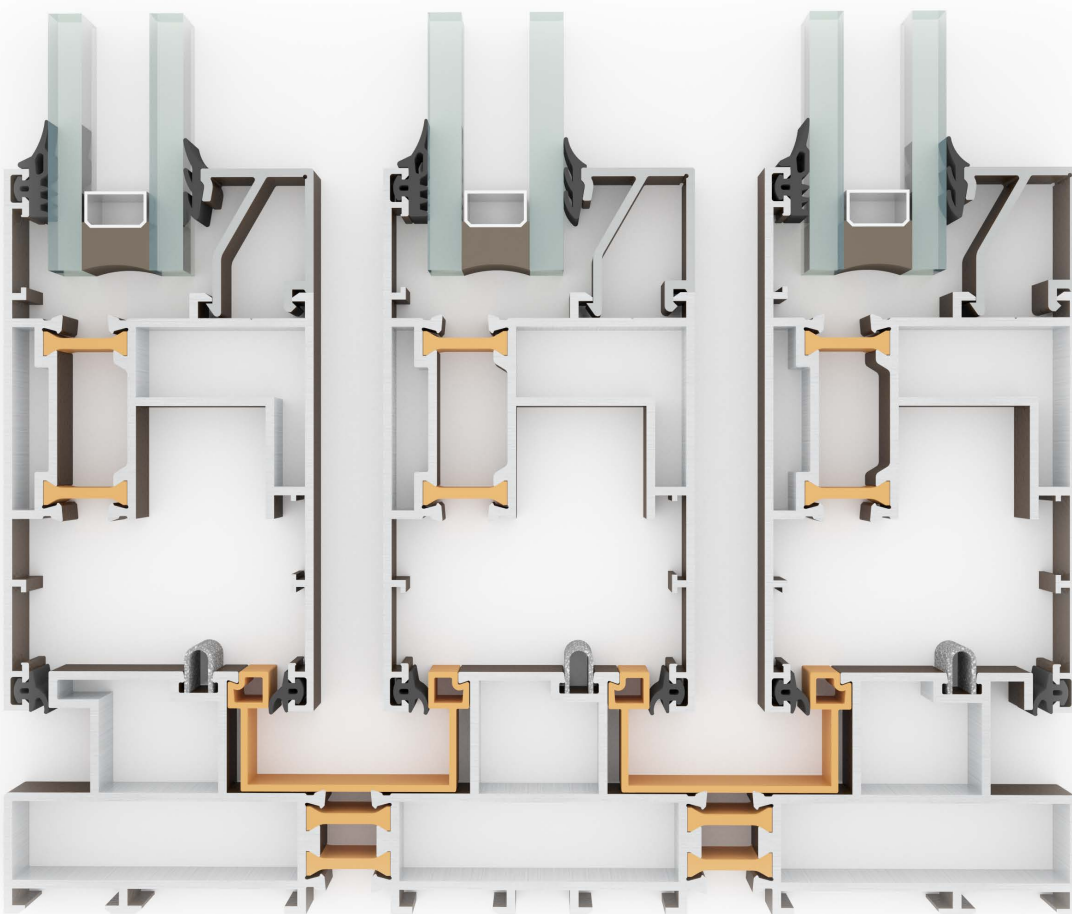

Aluminium Fabrication Products

Door & Window System Technical Catalog

کاتالوگ فنی سیستم های در و پنجره





**EXALCO**  
Aluminium Fabrication Products

- Made
- in
- IRAN

# H/S96

## لیف اسلاید

### Lift & Slide

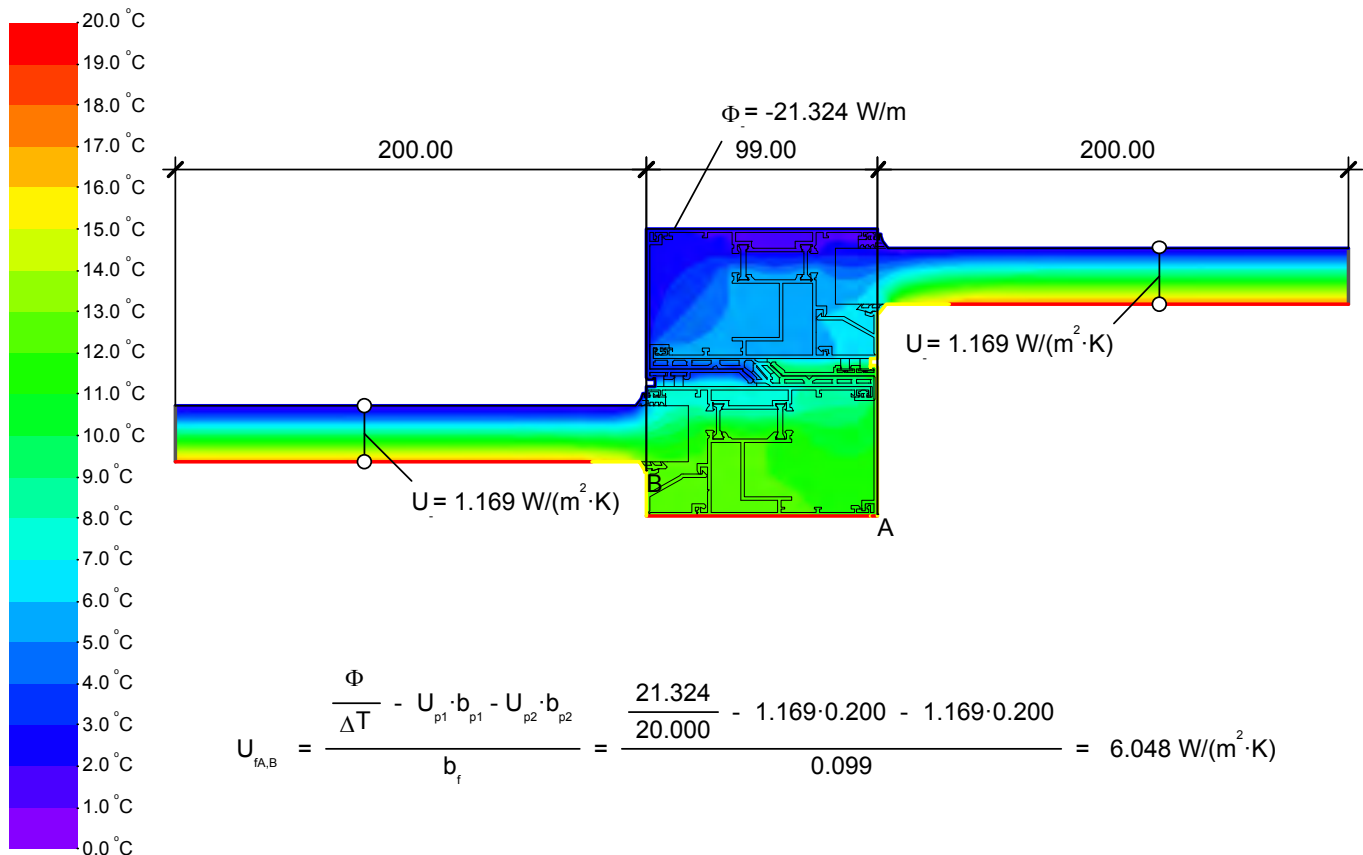
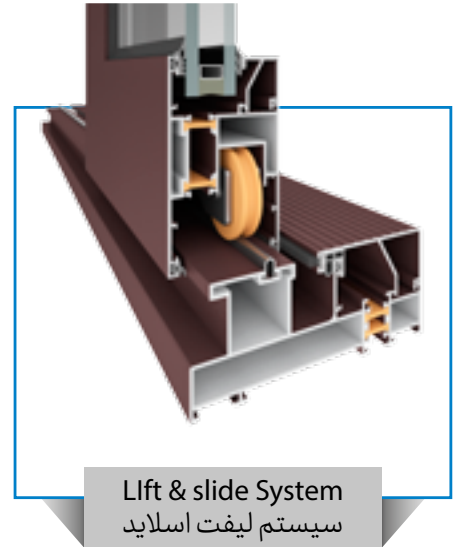
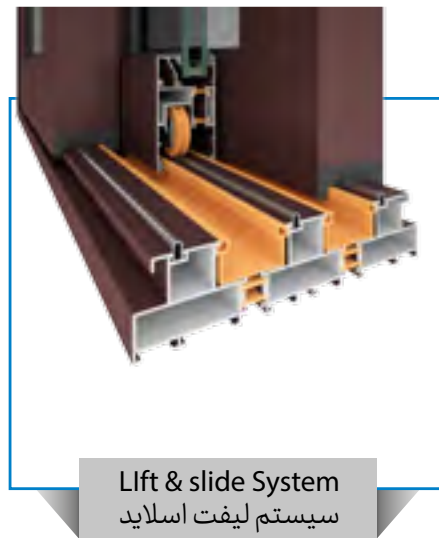
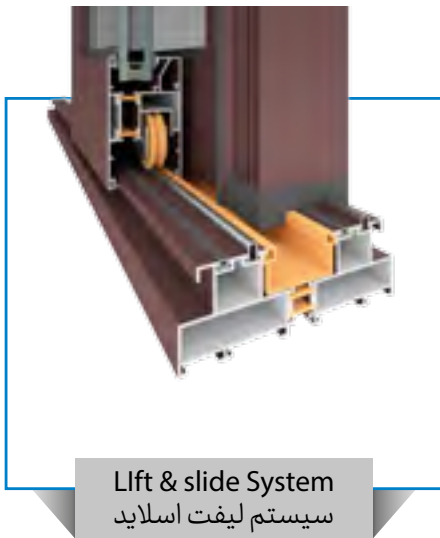

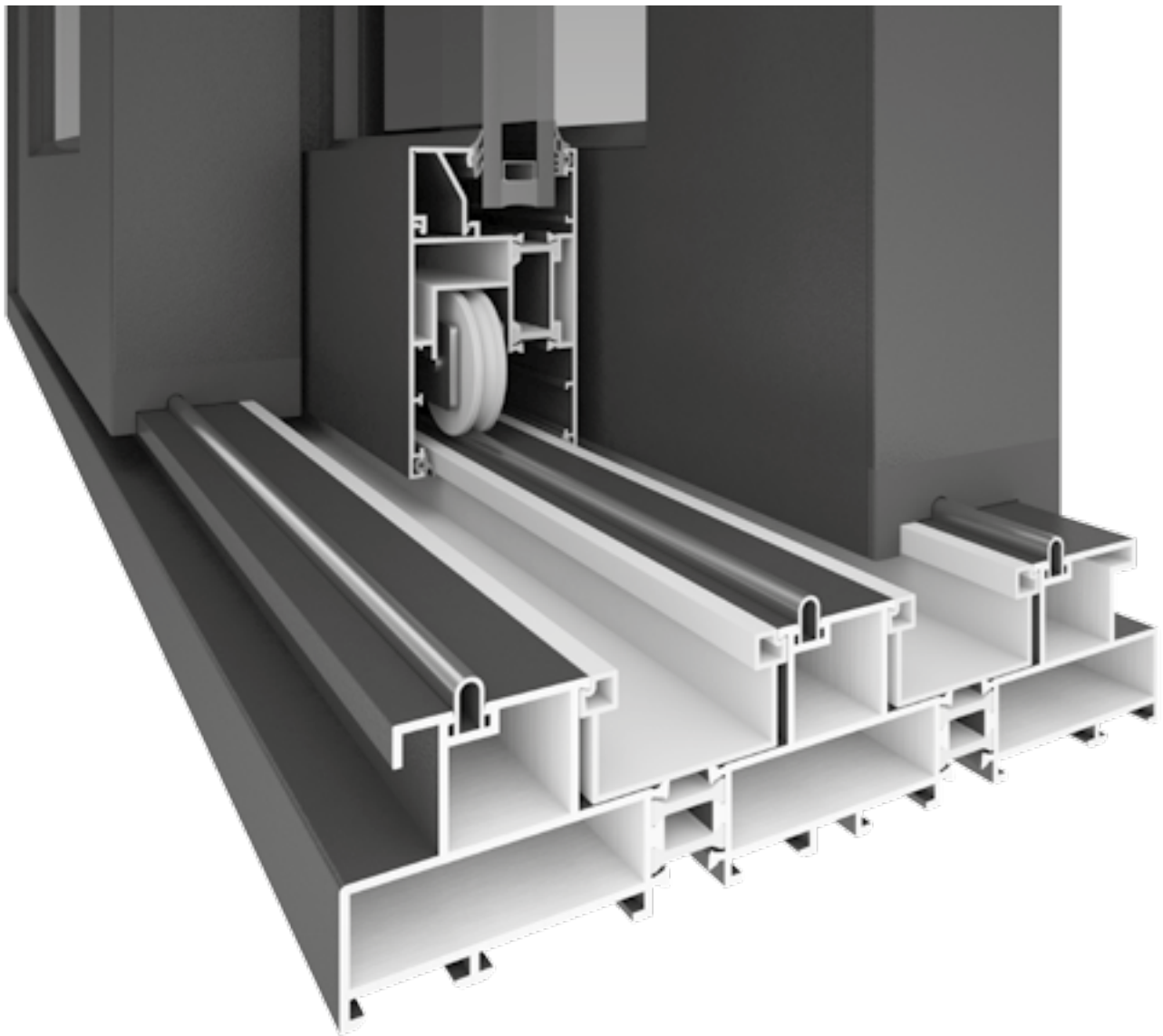

Profile No.	Weight (kg/m)	Static Value
کد پروفیل	وزن پروفیل	Jx (cm <sup>4</sup> ) Jy (cm <sup>4</sup> )
HS-96 10122-15	2.225 kg/m	15.22 / 109.43
HS-96 10124-15	2.265 kg/m	15.65 / 110.53
HS-96 12122-15	2.185 kg/m	16.11 / 114.68

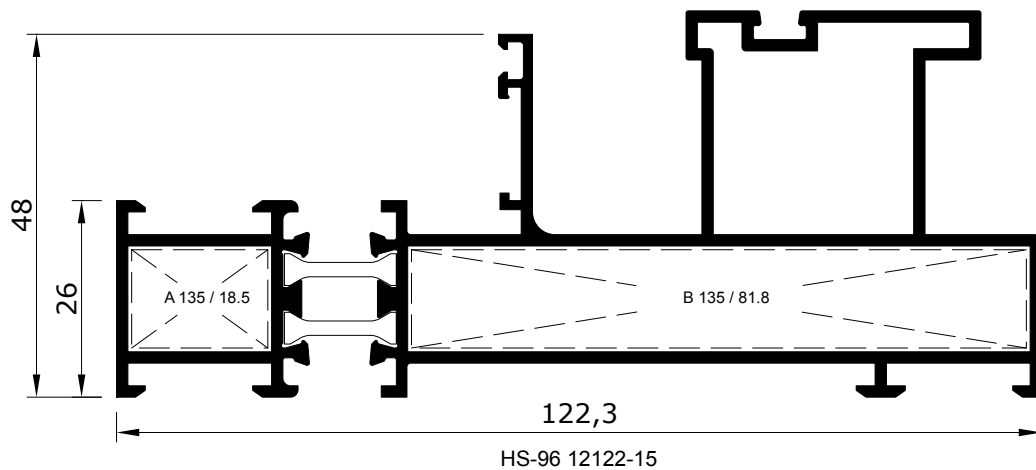
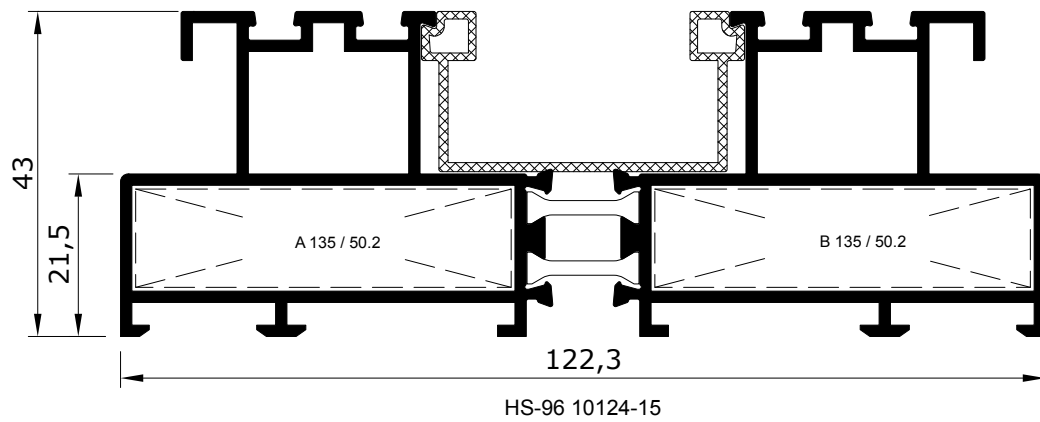
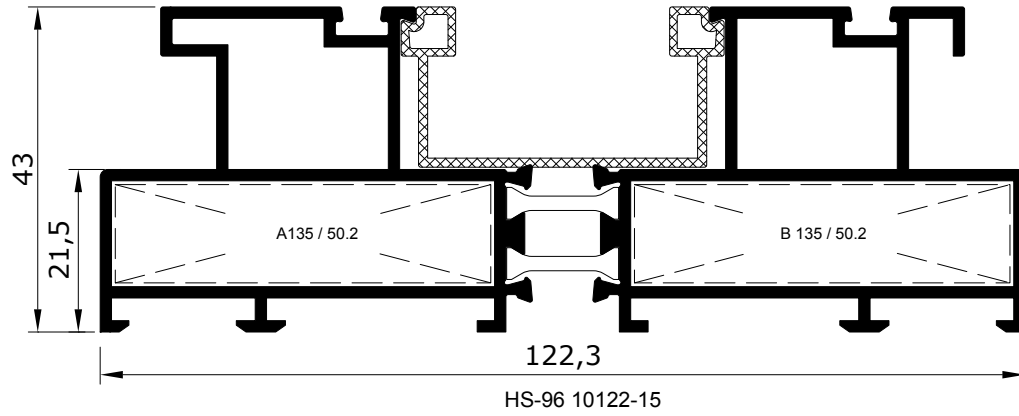

Profile No.	Weight (kg/m)	Static Value
کد پروفیل	وزن پروفیل	Jx (cm <sup>4</sup> ) Jy (cm <sup>4</sup> )
HS-96 10190-15	3.424 kg/m	22.61 / 401.29
HS-96 10192-15	3.490 kg/m	23.34 / 406.97

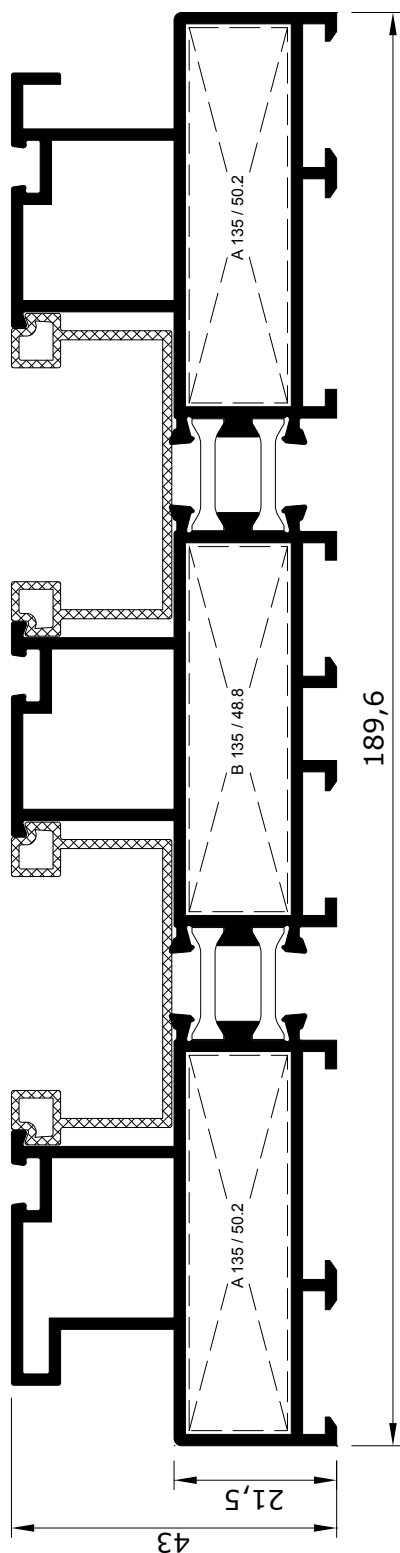

**Profiles**

HS-96 10190-15

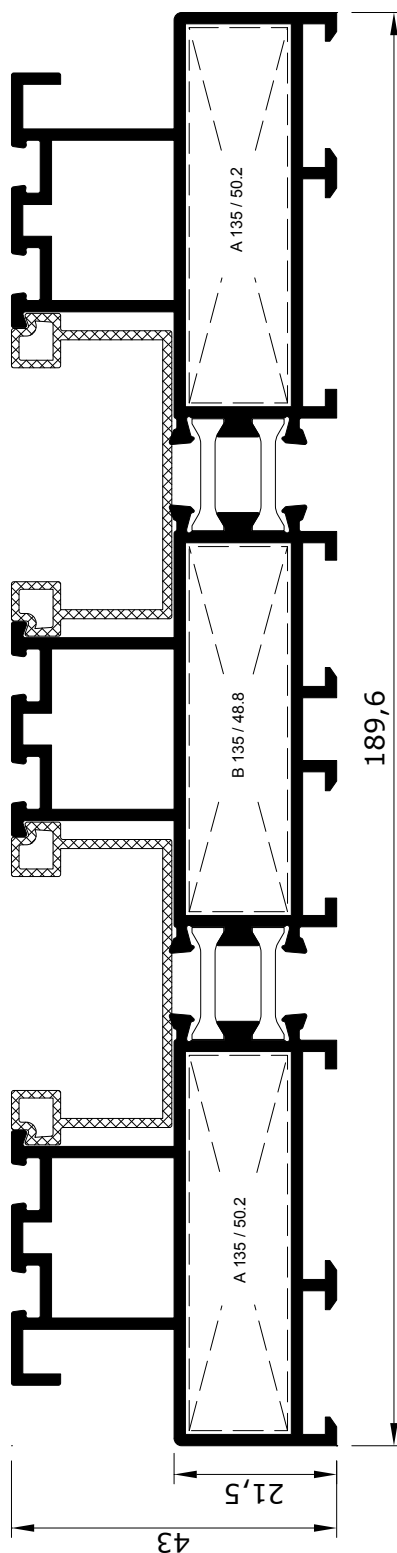

HS-96 10192-15

Profile No.	Weight (kg/m)	Static Value
کد پروفیل	وزن پروفیل	Jx (cm <sup>4</sup> ) Jy (cm <sup>4</sup> )
HS-96 20122-15	1.751 kg/m	6.64 / 87.46
EX-55 20080-15	1.425 kg/m	17.75 / 14.00
EX-55 20100-15	1.750 kg/m	22.59 / 34.88

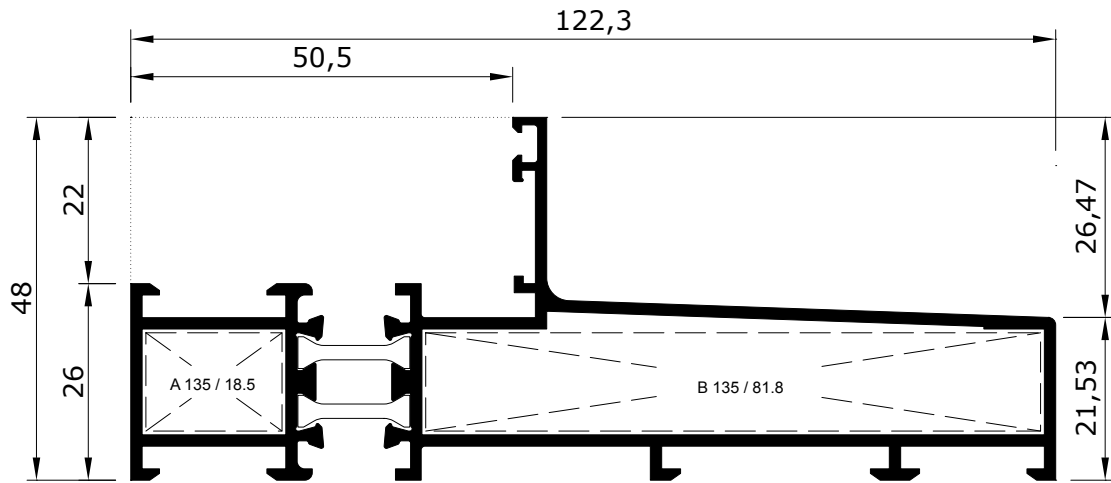

HS-96 20122-15

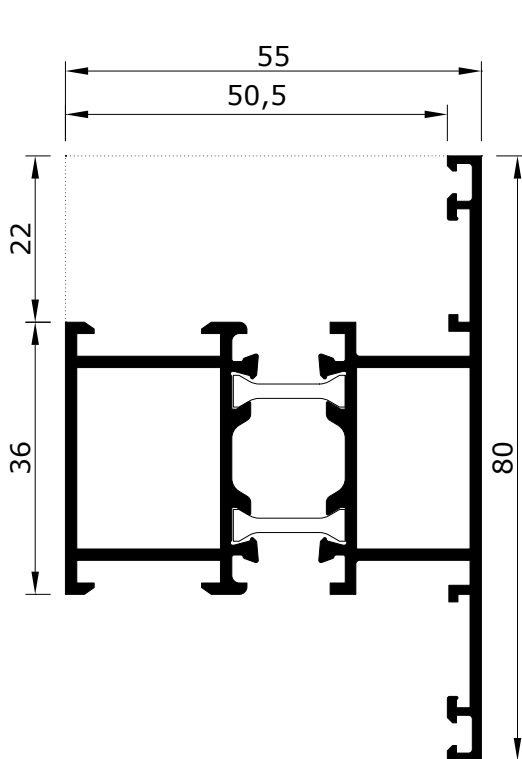

EX-55 20080-15

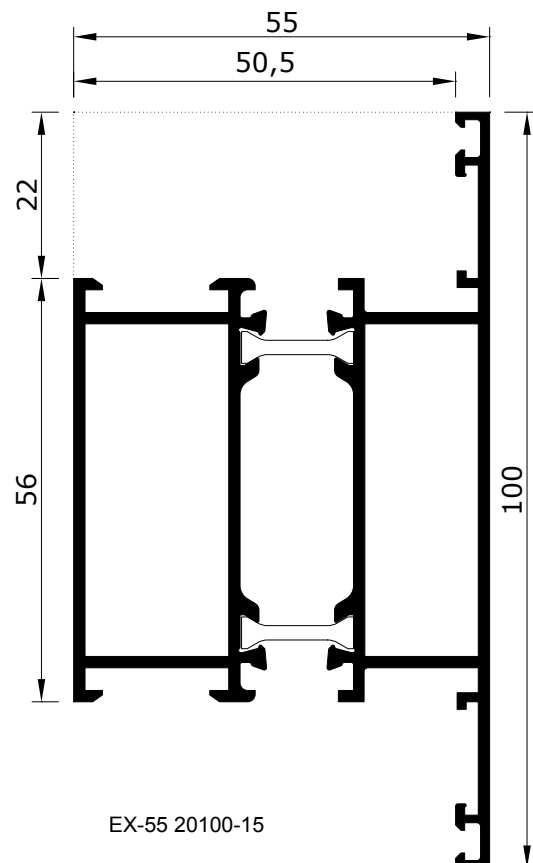

EX-55 20100-15

Profile No. کد پروفیل	Weight (kg/m) وزن پروفیل	Static Value Jx (cm <sup>4</sup> ) Jy (cm <sup>4</sup> )
HS-96 24122-15	2.307 kg/m	25.78 / 111.97
HS-96 30055-15	1.723 kg/m	
HS-96 30058-15	1.675 kg/m	

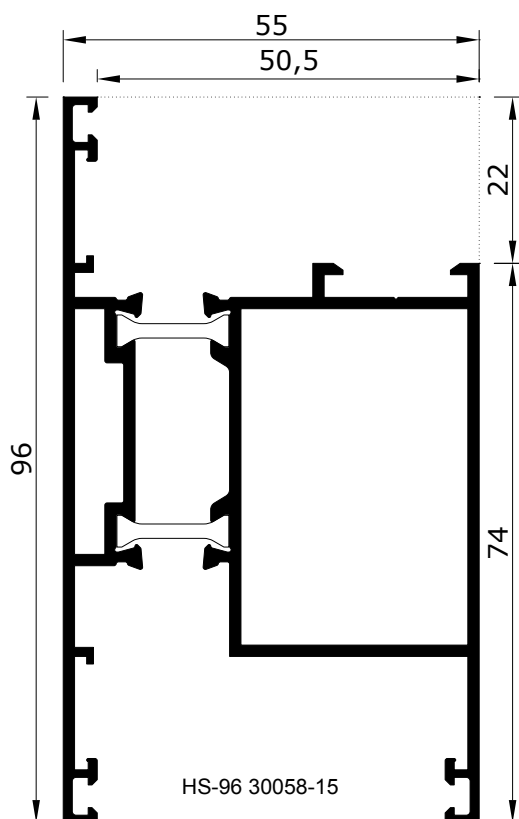
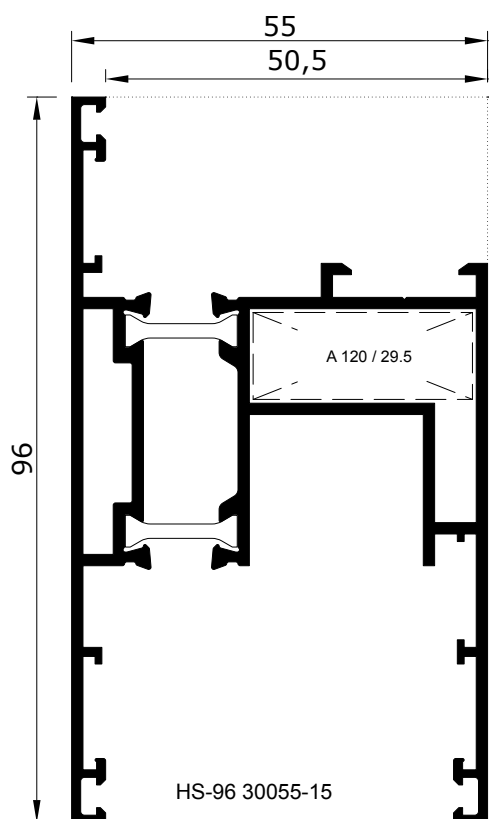
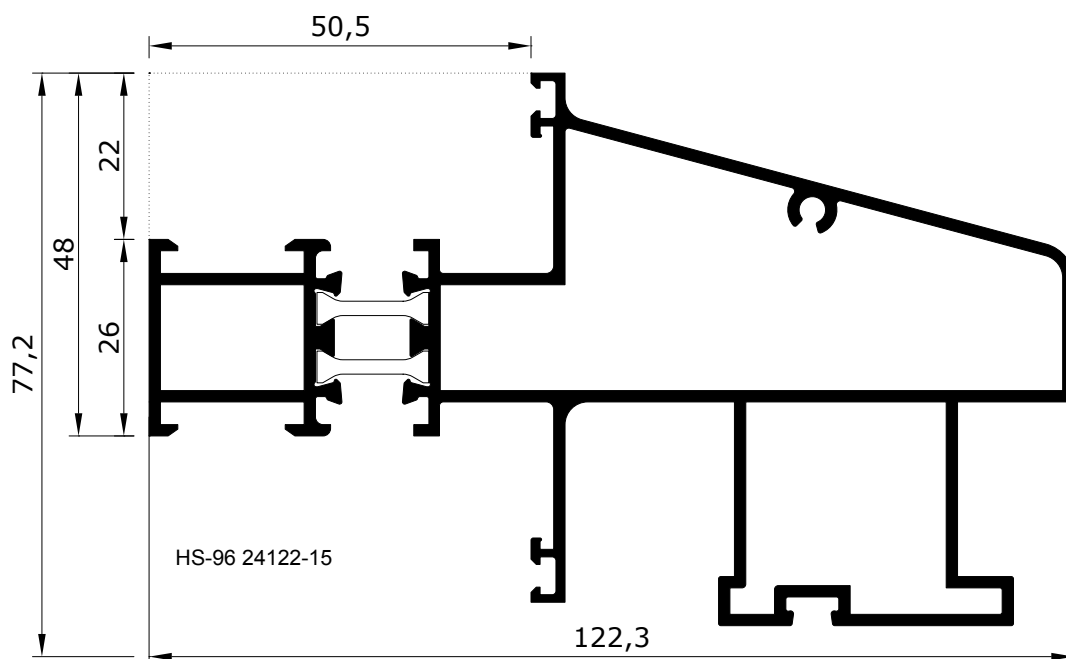



Profile No.	Weight (kg/m)
کد پروفیل	وزن پروفیل
HS-96 40052-15	0.592 kg/m
HS-96 40053-15	0.523 kg/m
HS-96 40122-15	0.586 kg/m
HS-96 40022-15	1.178 kg/m

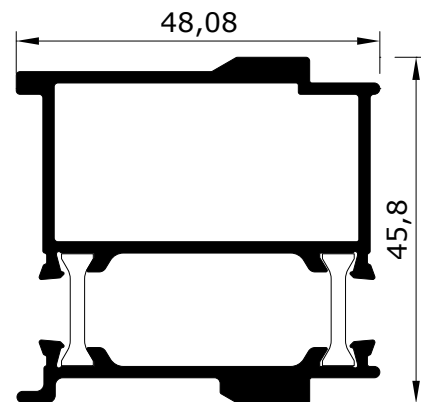
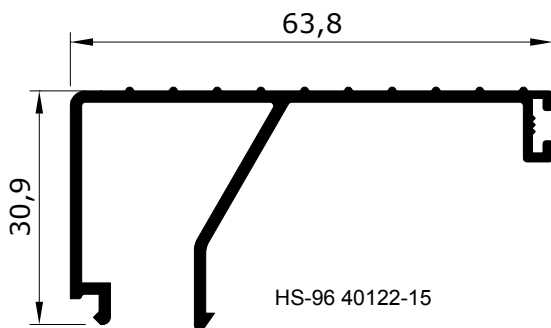
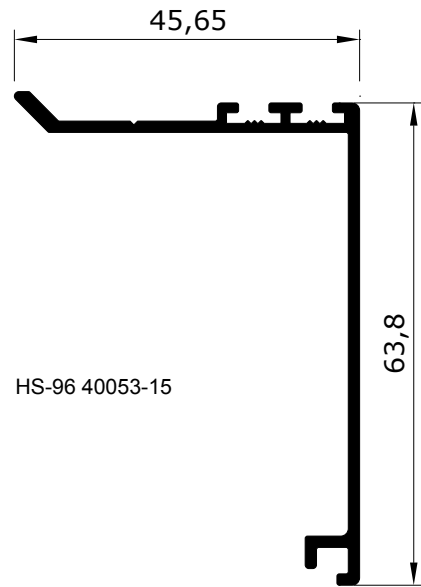
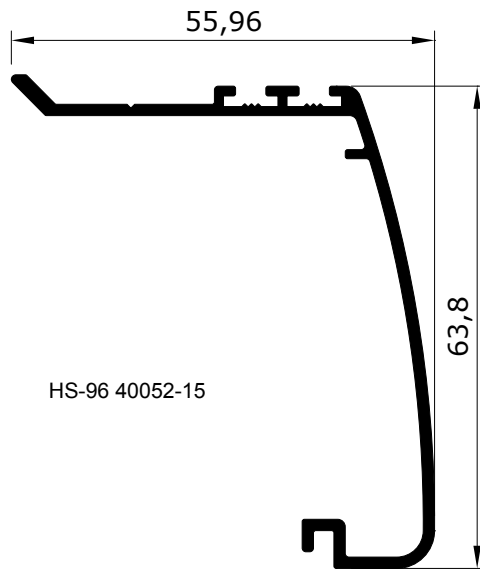

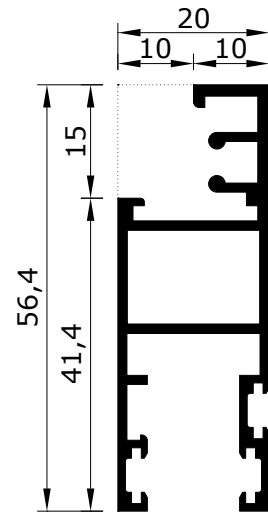

0.627 kg/m  
PC - 120 / 17.1 mm

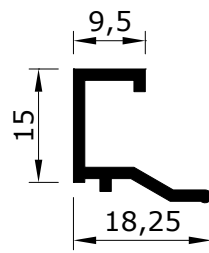

0.178 kg/m

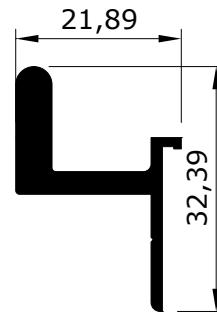



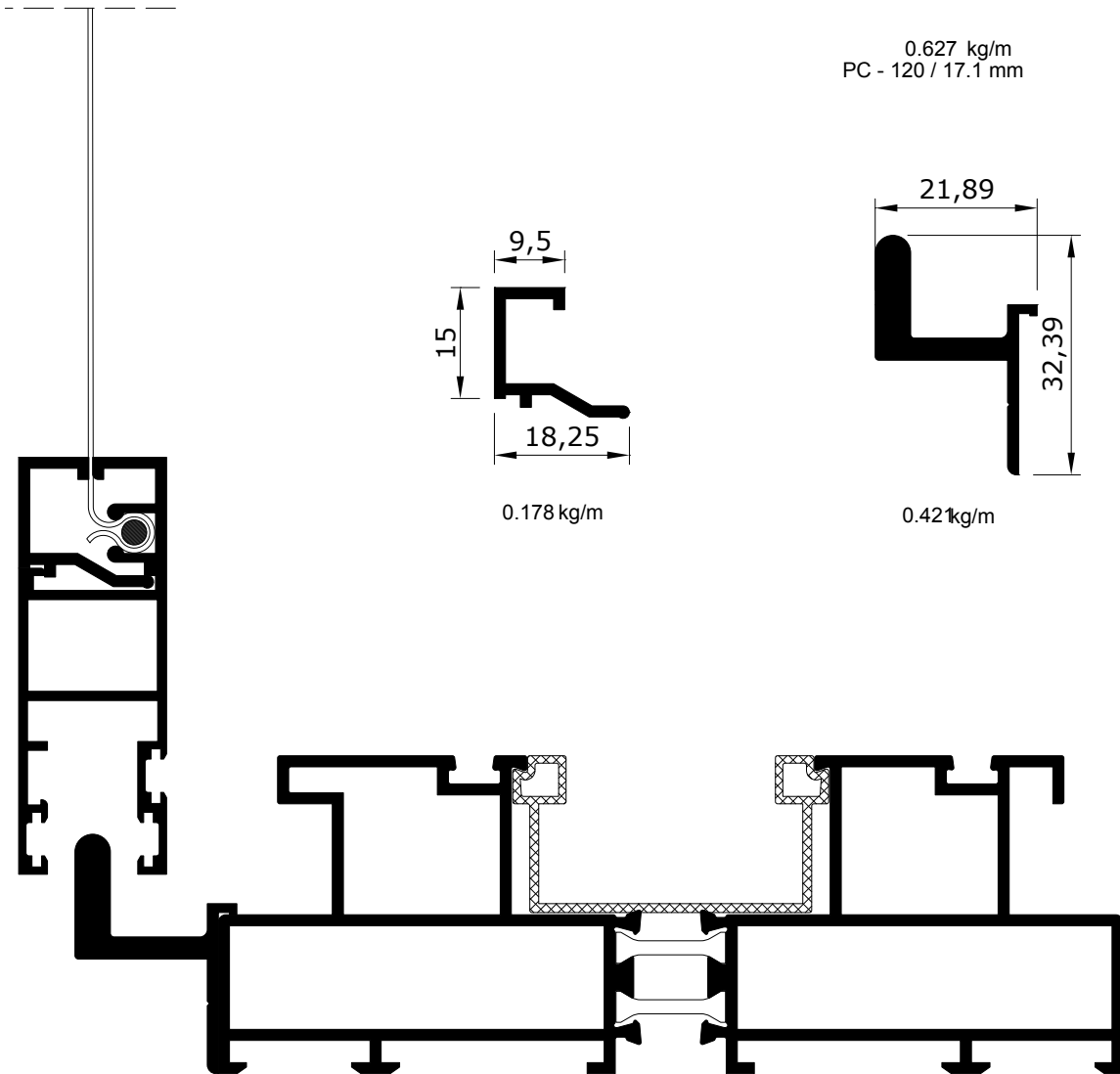



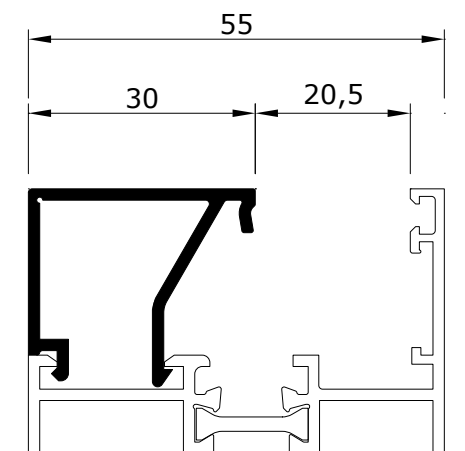
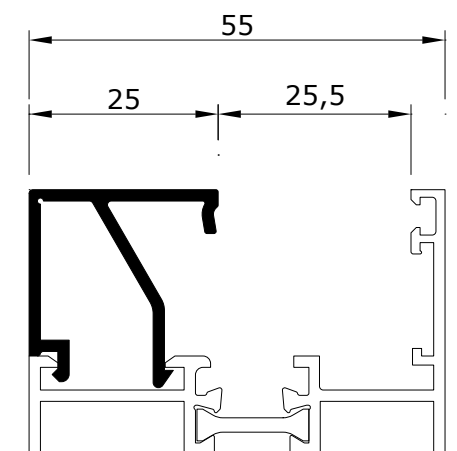
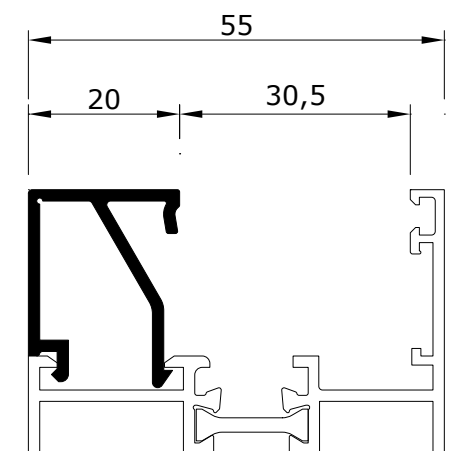
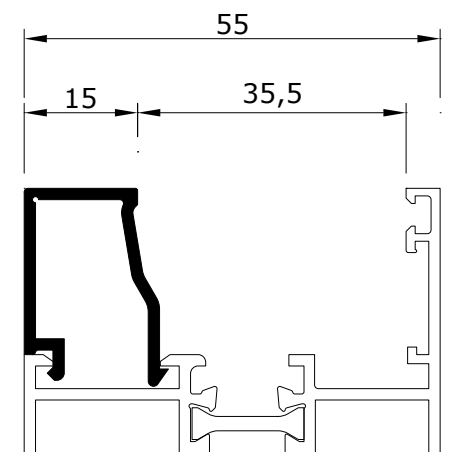
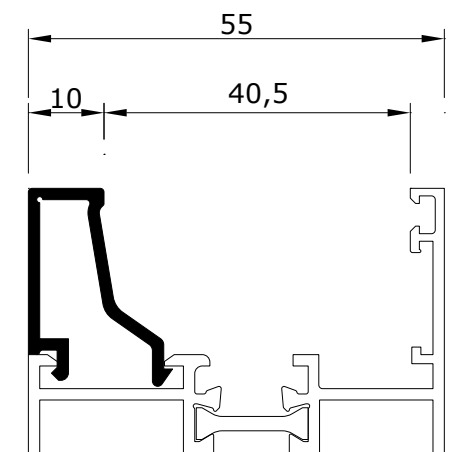

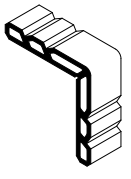
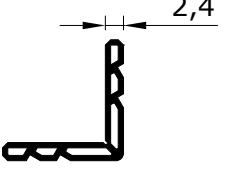
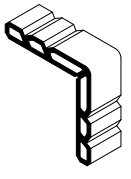
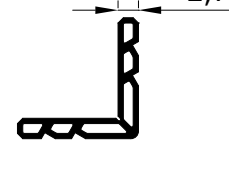
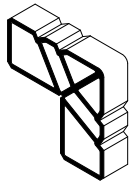
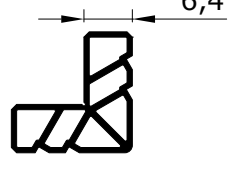
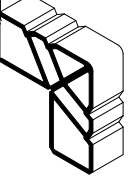
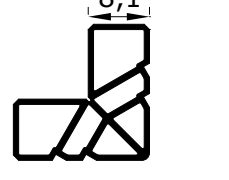
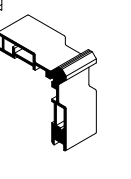
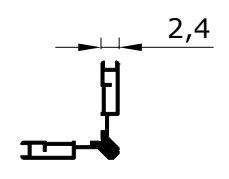

0.42 kg/m



HS-96 10122-15

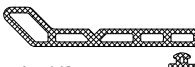

<b>3D Picture</b> تصویر سه بعدی	<b>2D Picture</b> تصویر محصول	<b>Features</b> مشخصات فنی	<b>Used Profiles</b> پروفیل مصرفی
		PC-120  3.124 Kg/m	HS-96 30055-15
		PC-135  3.256 Kg/m	HS-96 10122-15 HS-96 10124-15 HS-96 12122-15 HS-96 20122-15 HS-96 10190-15 HS-96 10192-15
		PC-320  4.202 Kg/m	
		PC-405  5.101 Kg/m	
		GC-120  1.712 Kg/m	

تصویر محصول Picture	کد محصول Piece No.	نوع متریال Material	مشخصات فنی Description
	GP-200	TPV/NBR	لاستیک ۲ میل داخلی Interior Glazing Gasket 2 mm
	GP-300		لاستیک ۳/۵ میل داخلی Interior Glazing Gasket 3.5 mm
	GP-400		لاستیک ۵ میل داخلی Interior Glazing Gasket 5 mm
	GP500		لاستیک ۶/۵ میل داخلی Interior Glazing Gasket 6.5 mm
	GP-100		لاستیک لنگه داخلی Interior Overlap Gasket
	GP-122		لاستیک کپ Frame Cover Profile Support Gasket
	GP-600		لاستیک پشت شیشه Exterior Glazing Gasket
 Scale:1/2	GP-055		لاستیک پروفیل مرکزی Central Cramp profile
	GP-150		لاستیک خارجی لنگه Exterior Overlap Gasket
	GP-120		لاستیک انتهای لنگه Sash Bottom & Side Overlap Gasket
	GP-110	لاستیک ابتدایی لنگه Sash Top Overlap Gasket	
	GP-101	لاستیک فریم Channel Cover Gasket	
	SSR-001	پروفیل ریل Rail Profile	
		گردگیر Extended Brush Gasket	

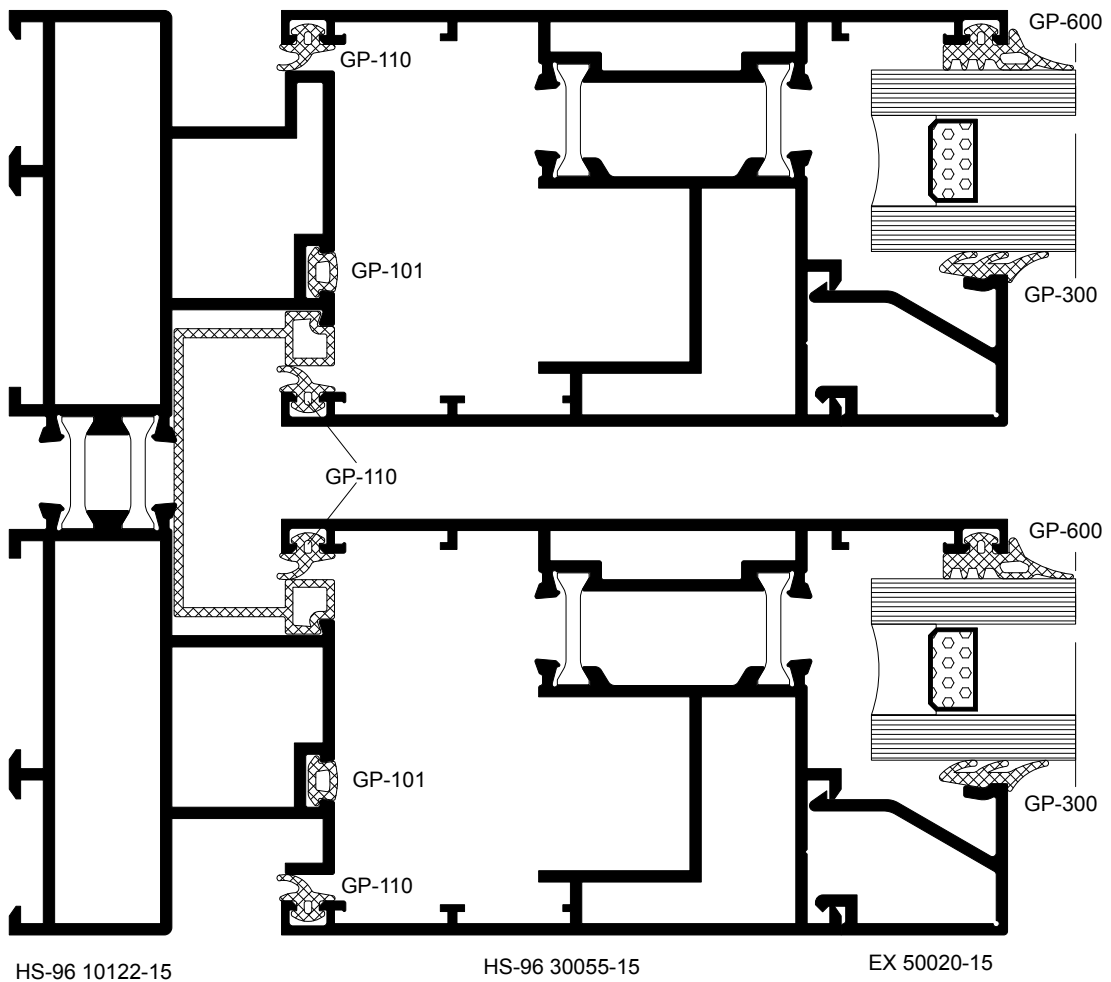
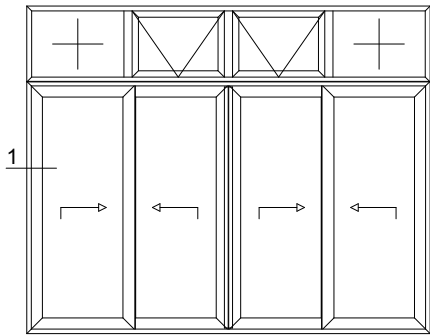

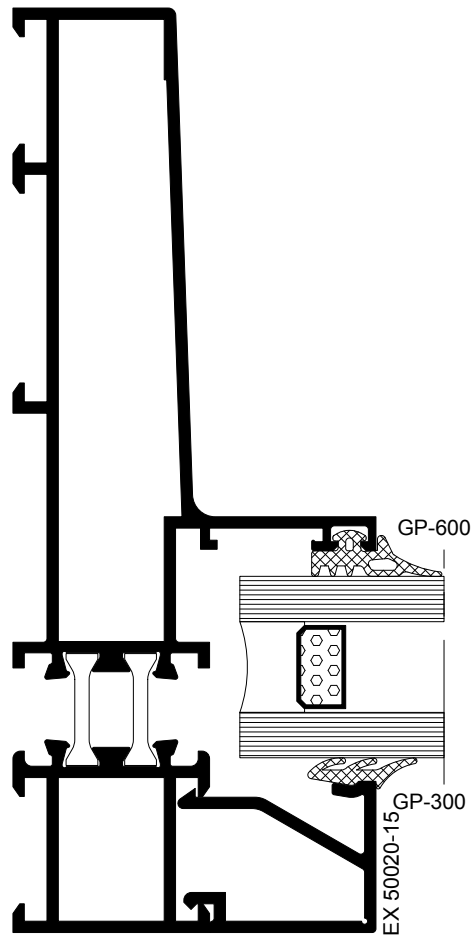
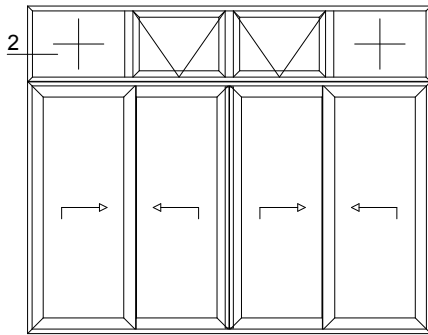

HS-96 20122-15

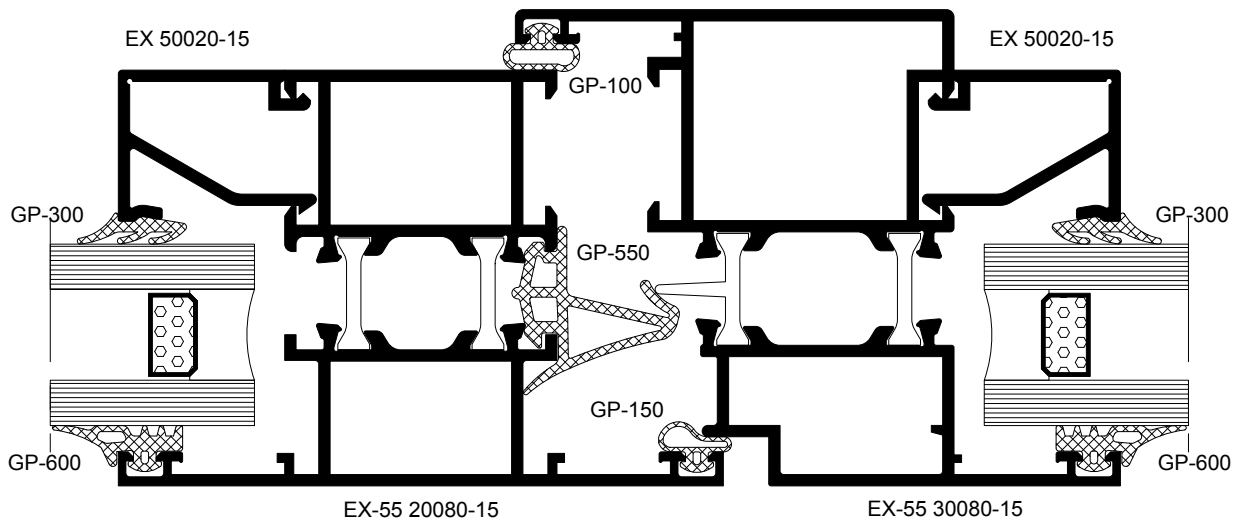
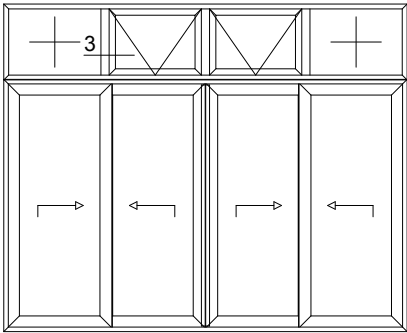



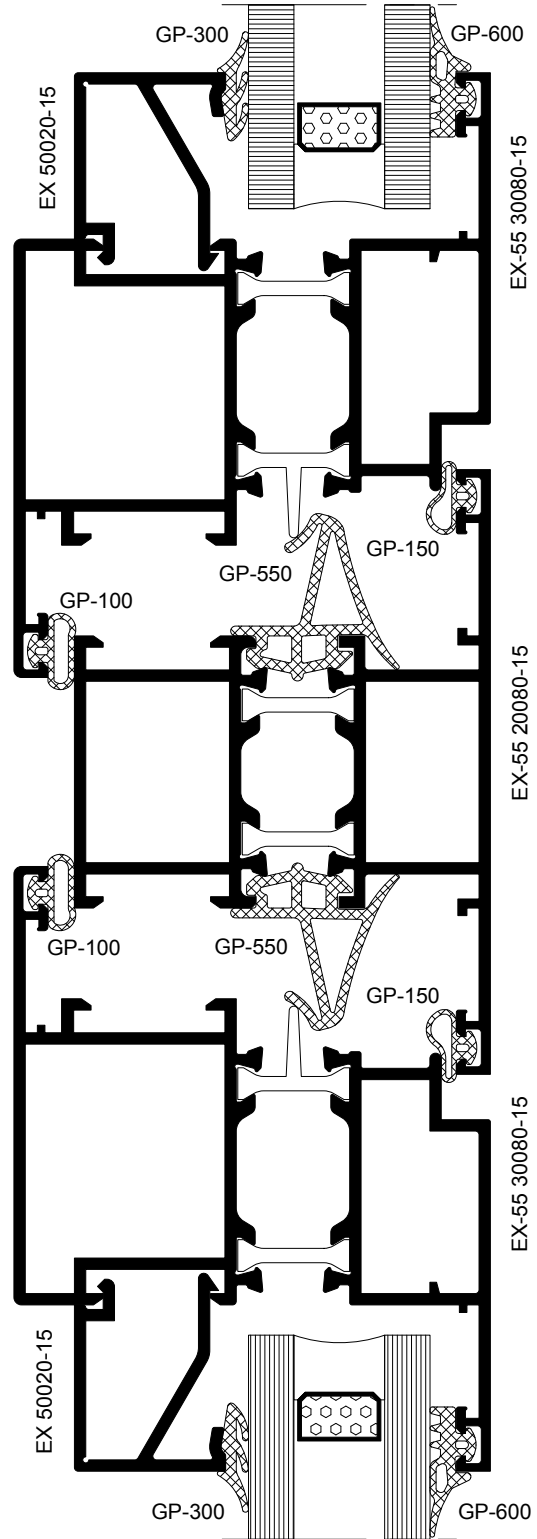
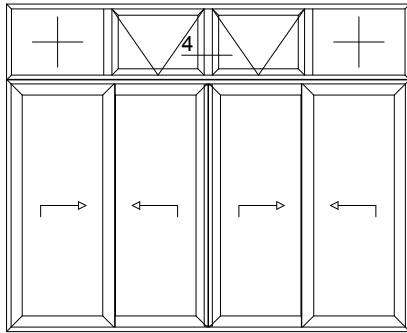

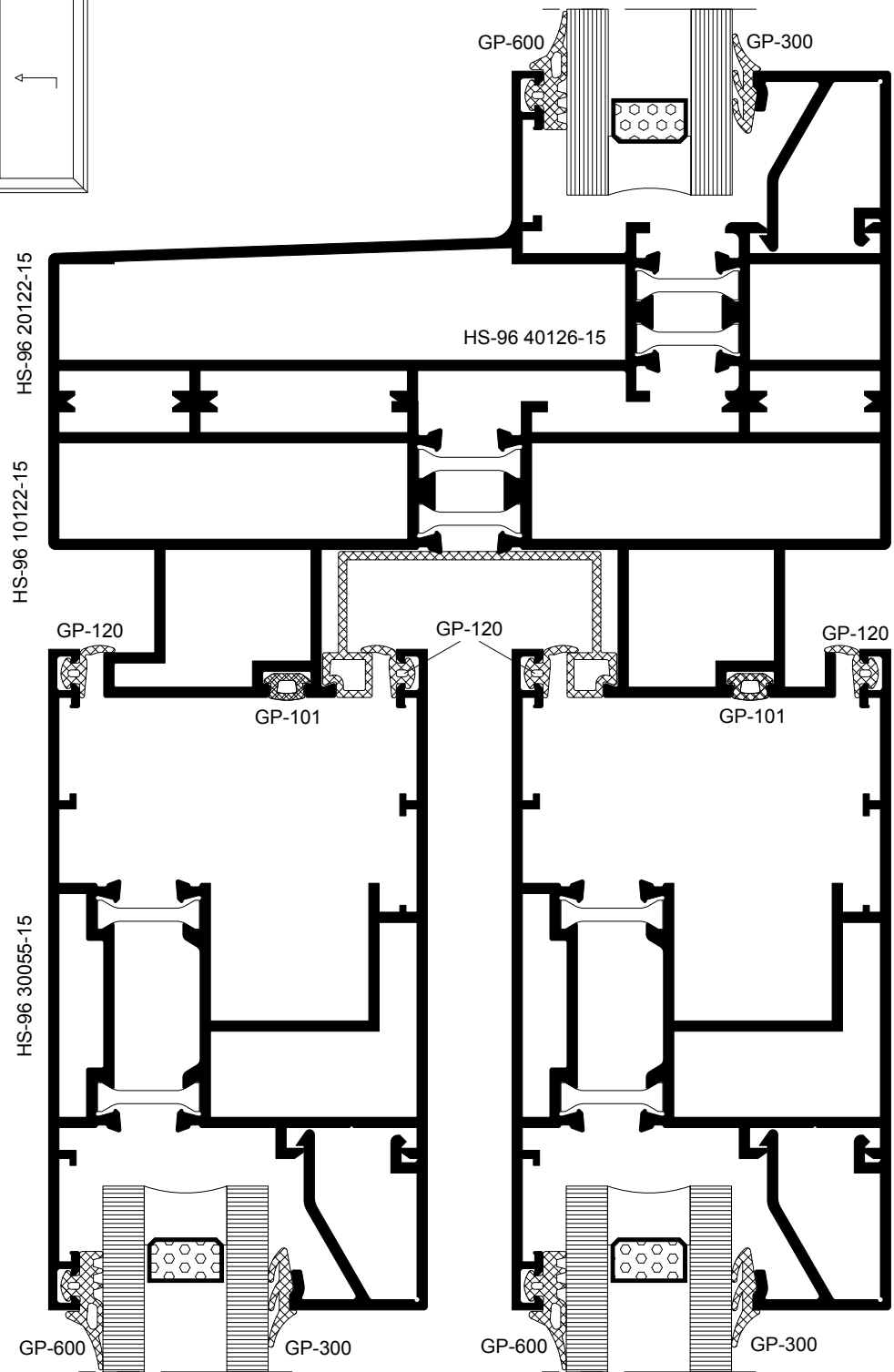
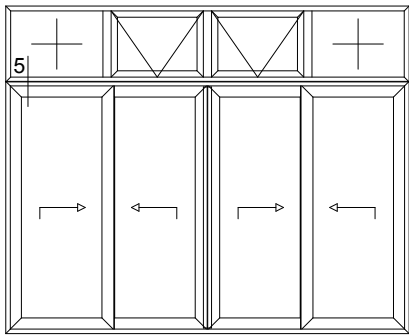

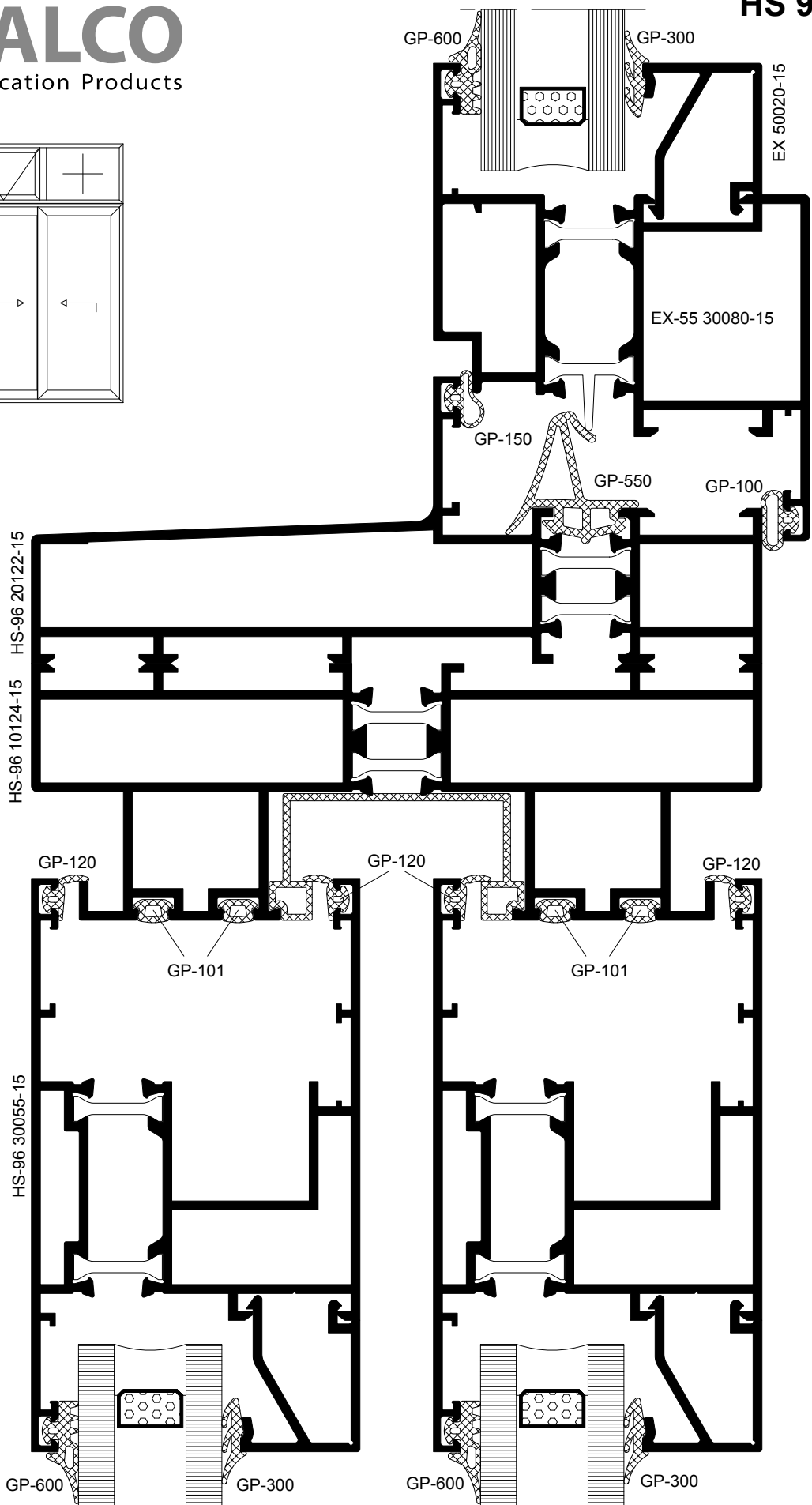
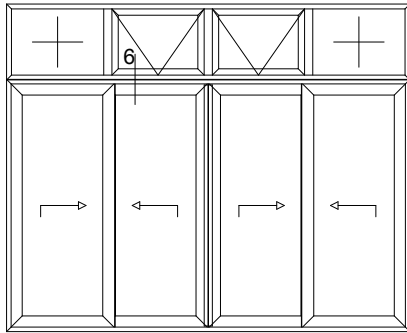

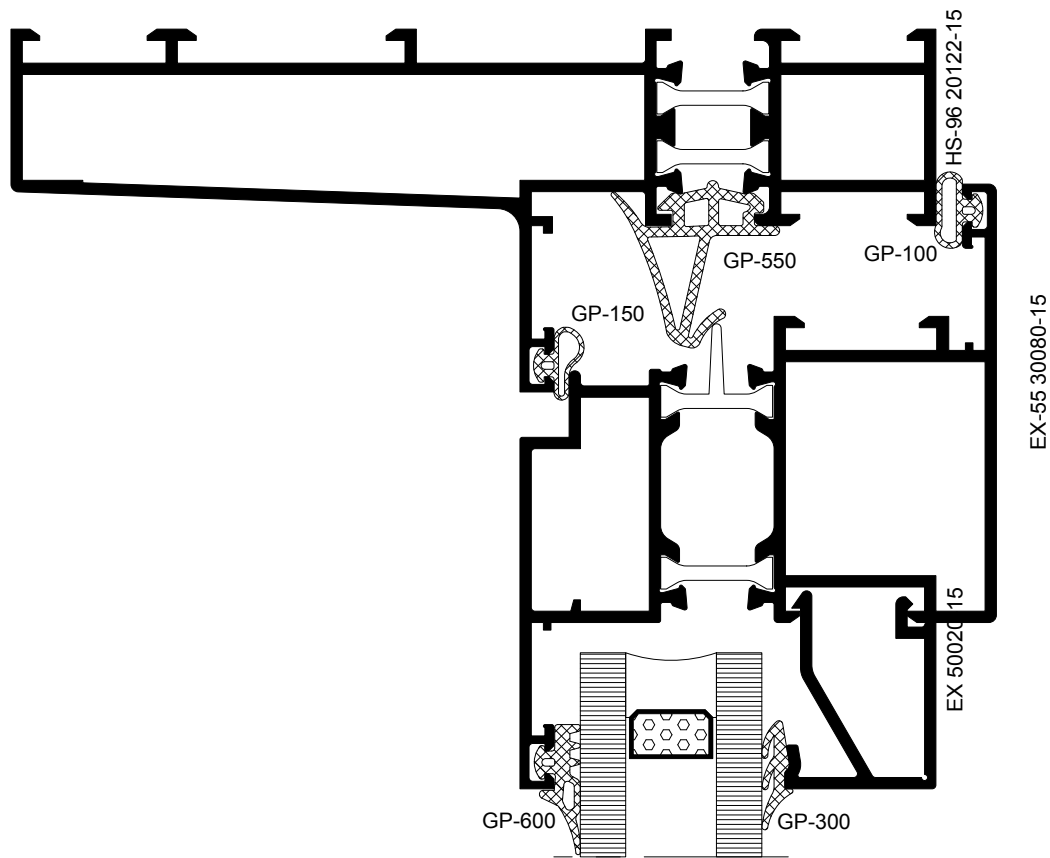
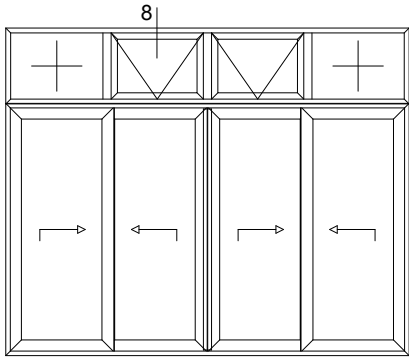

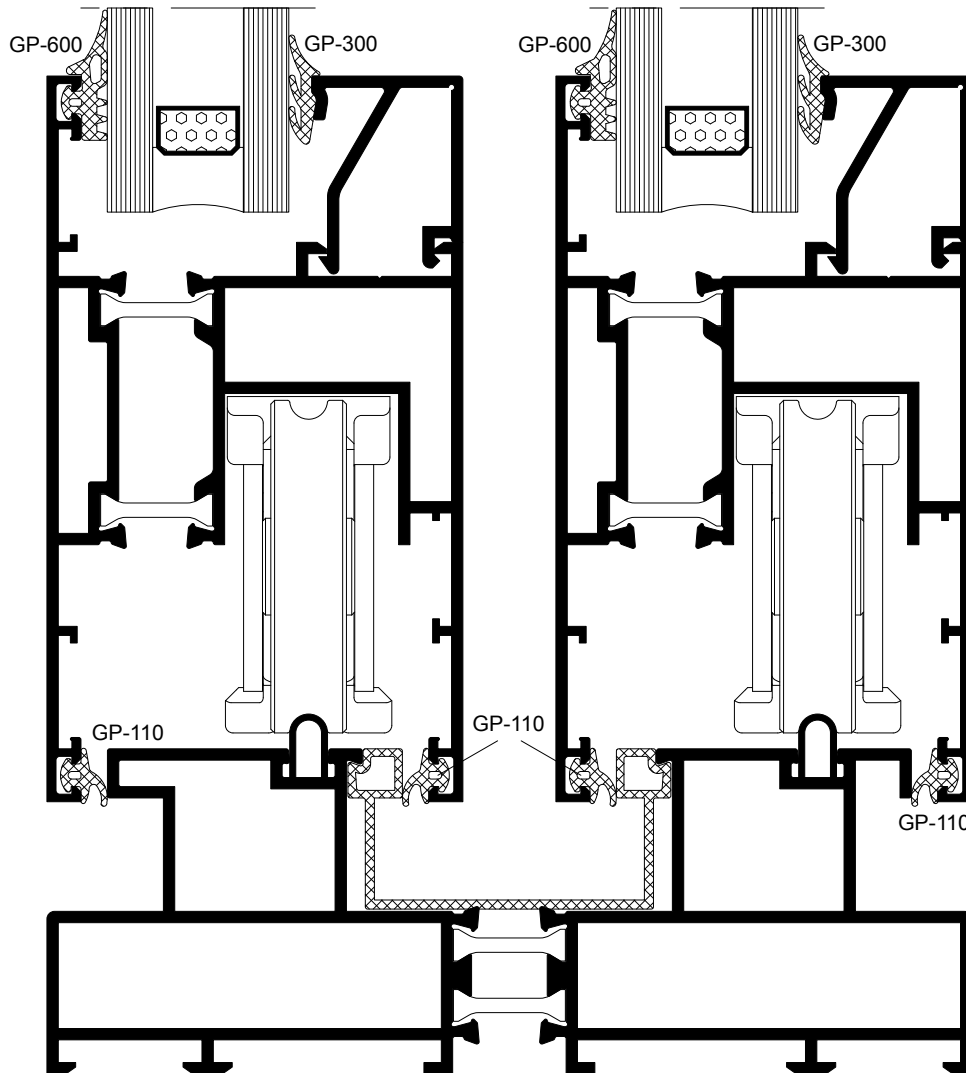
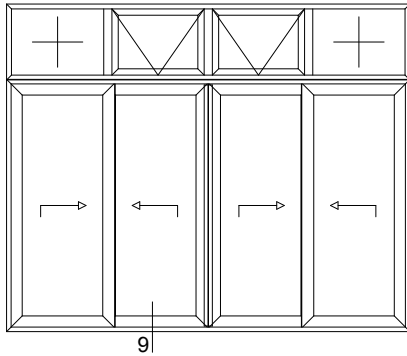

EX 50020-15

HS-96 30055-15

HS-96 10122-15

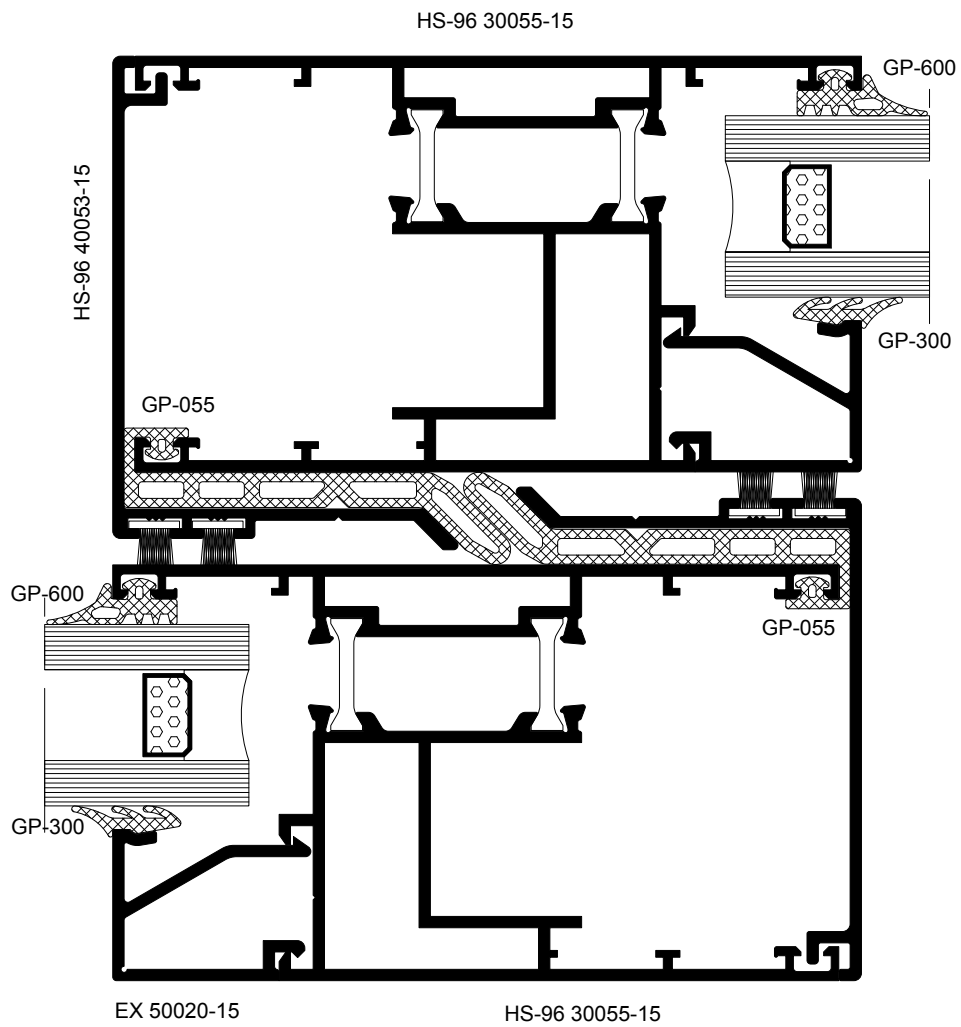
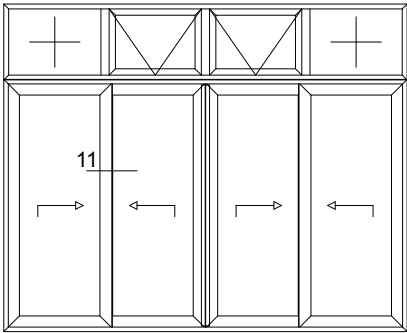

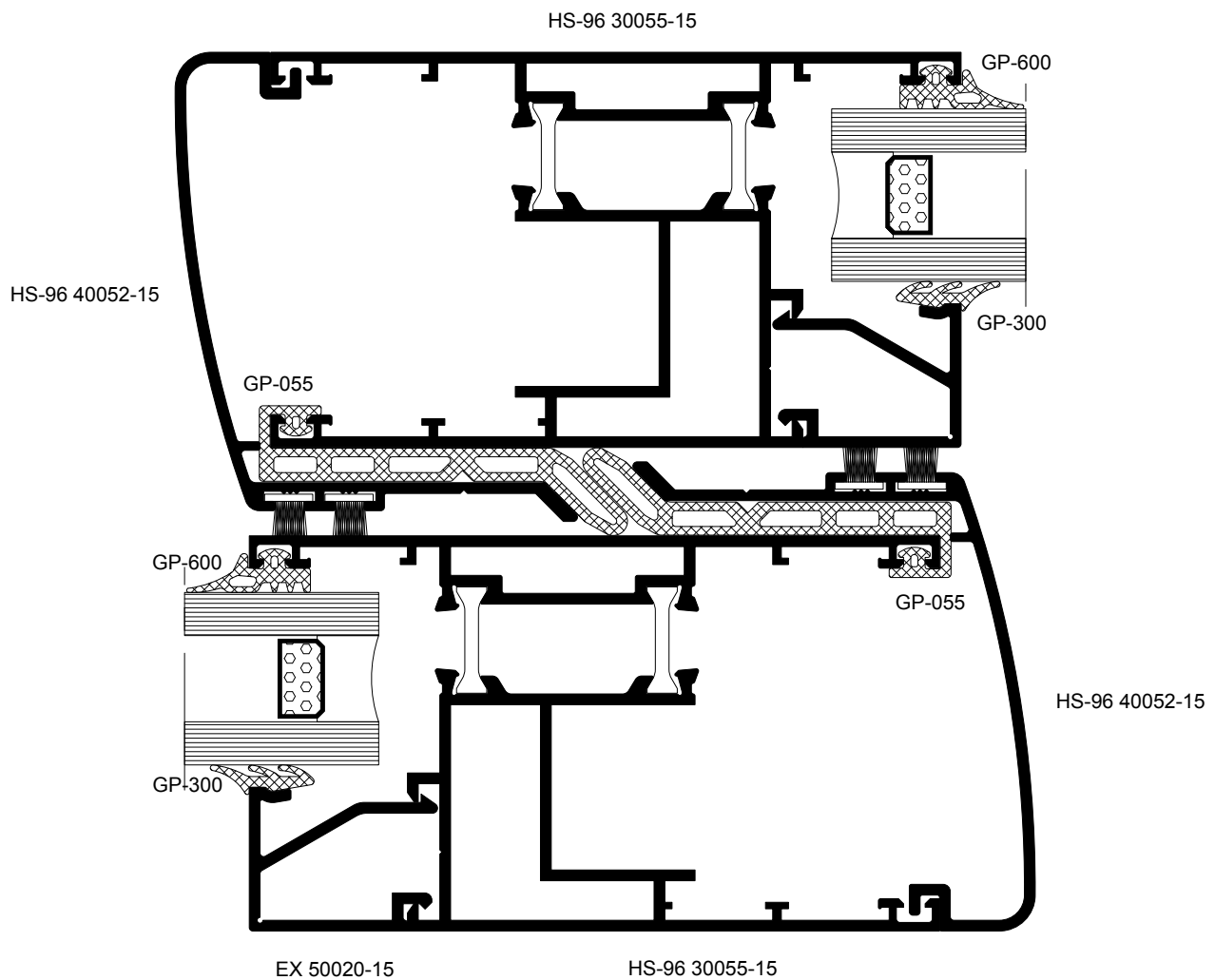
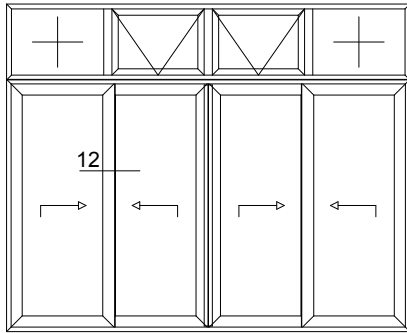

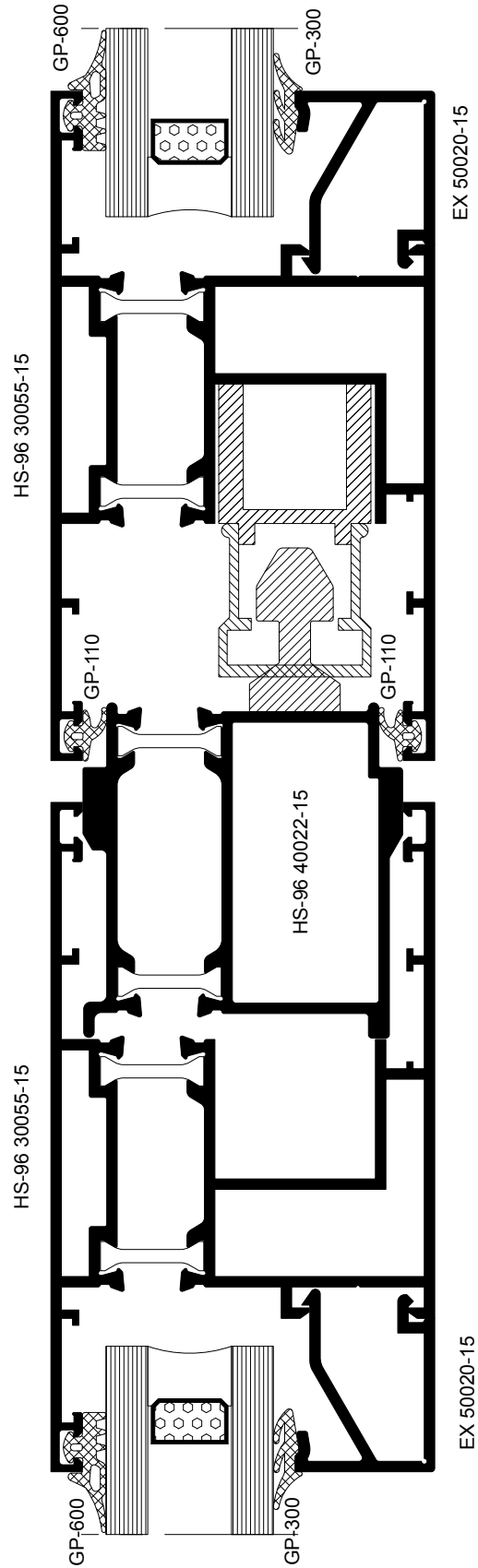
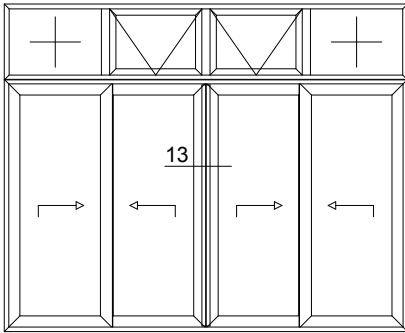



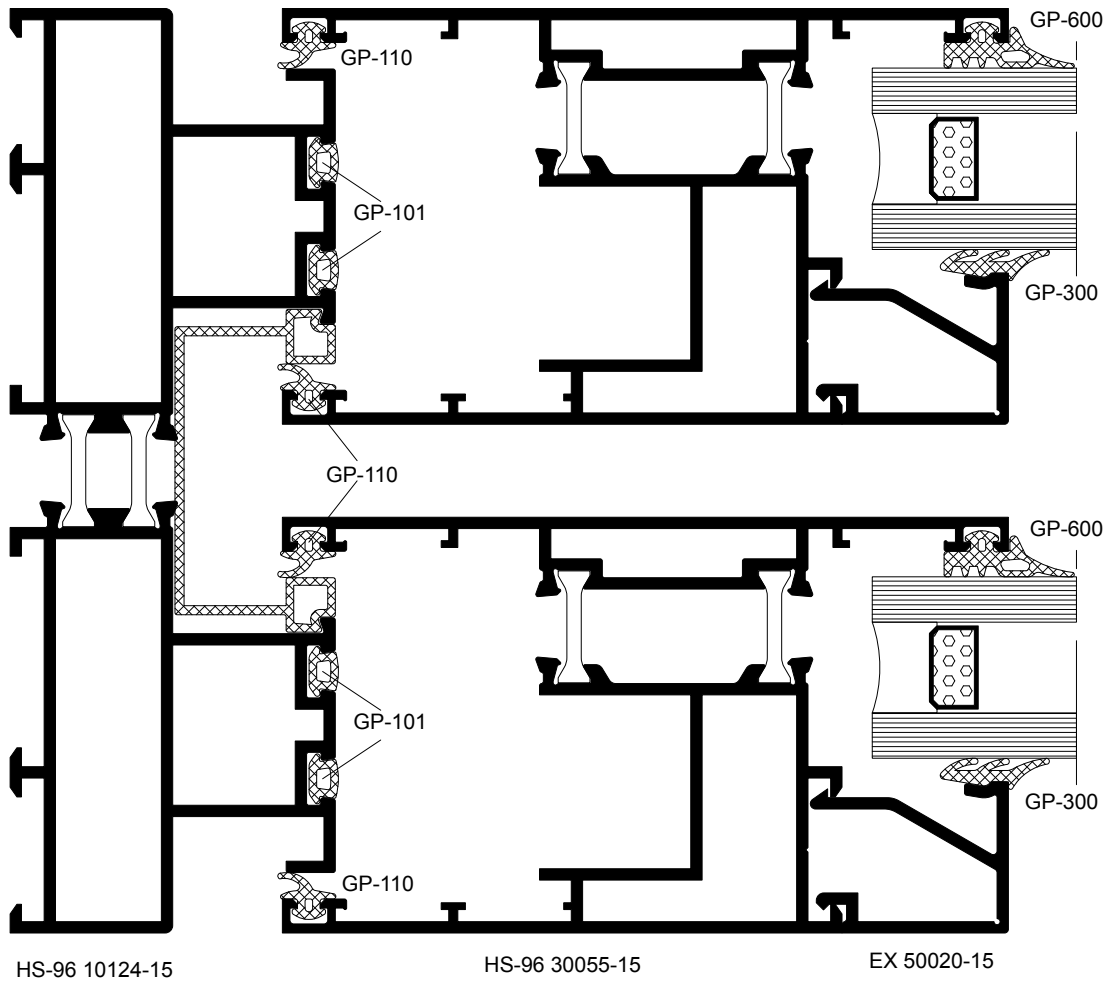
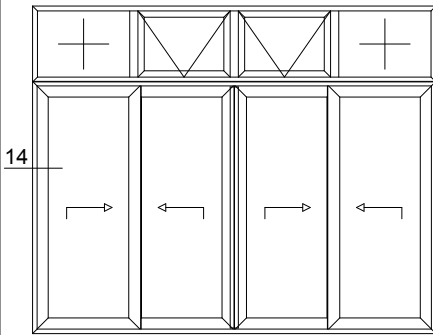

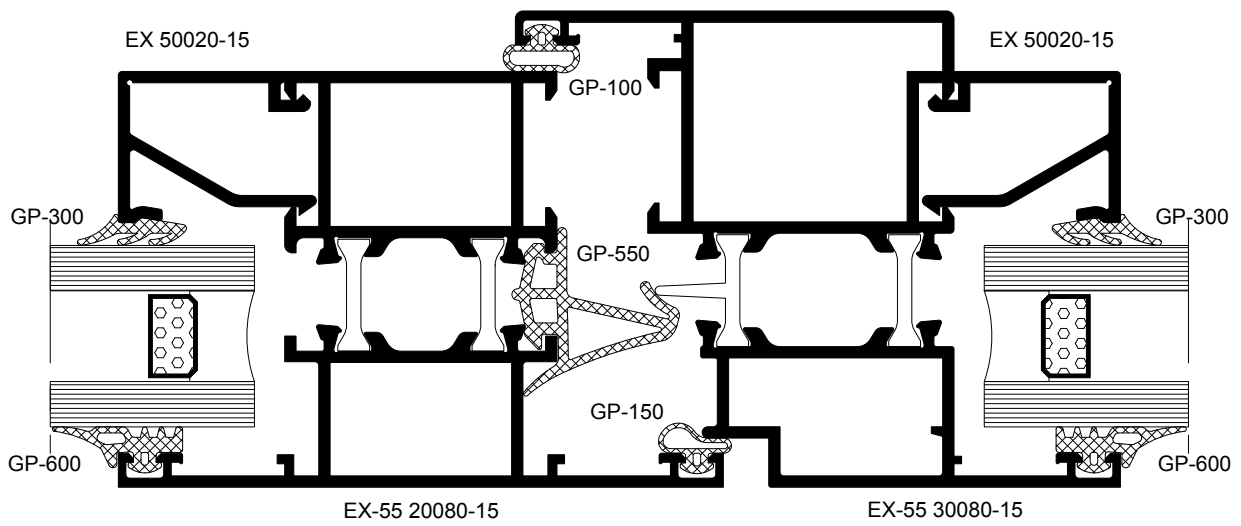
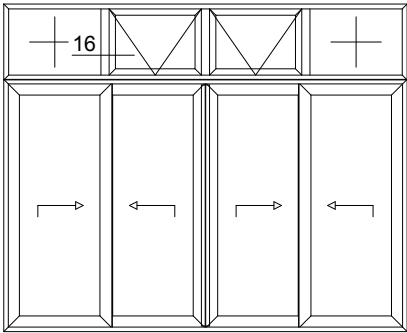

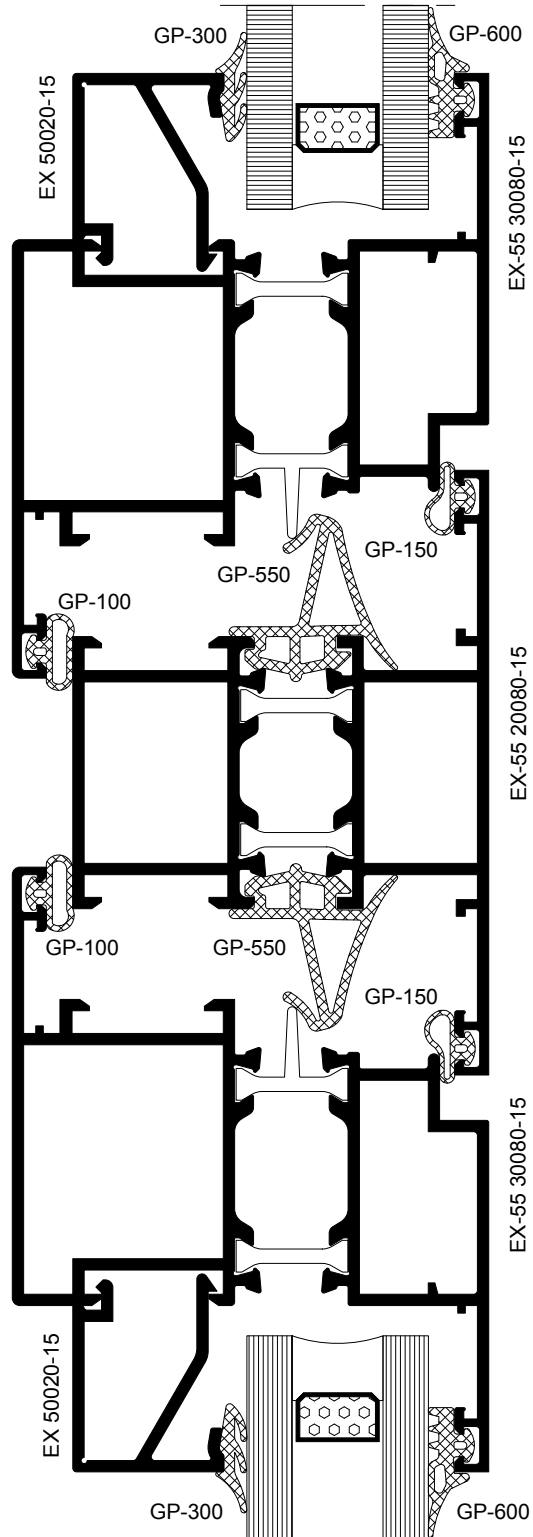
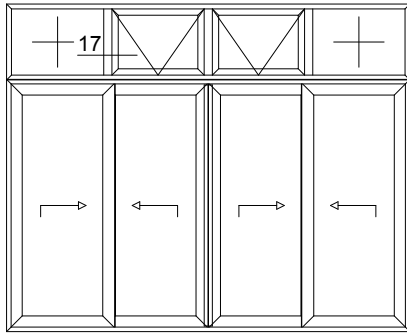

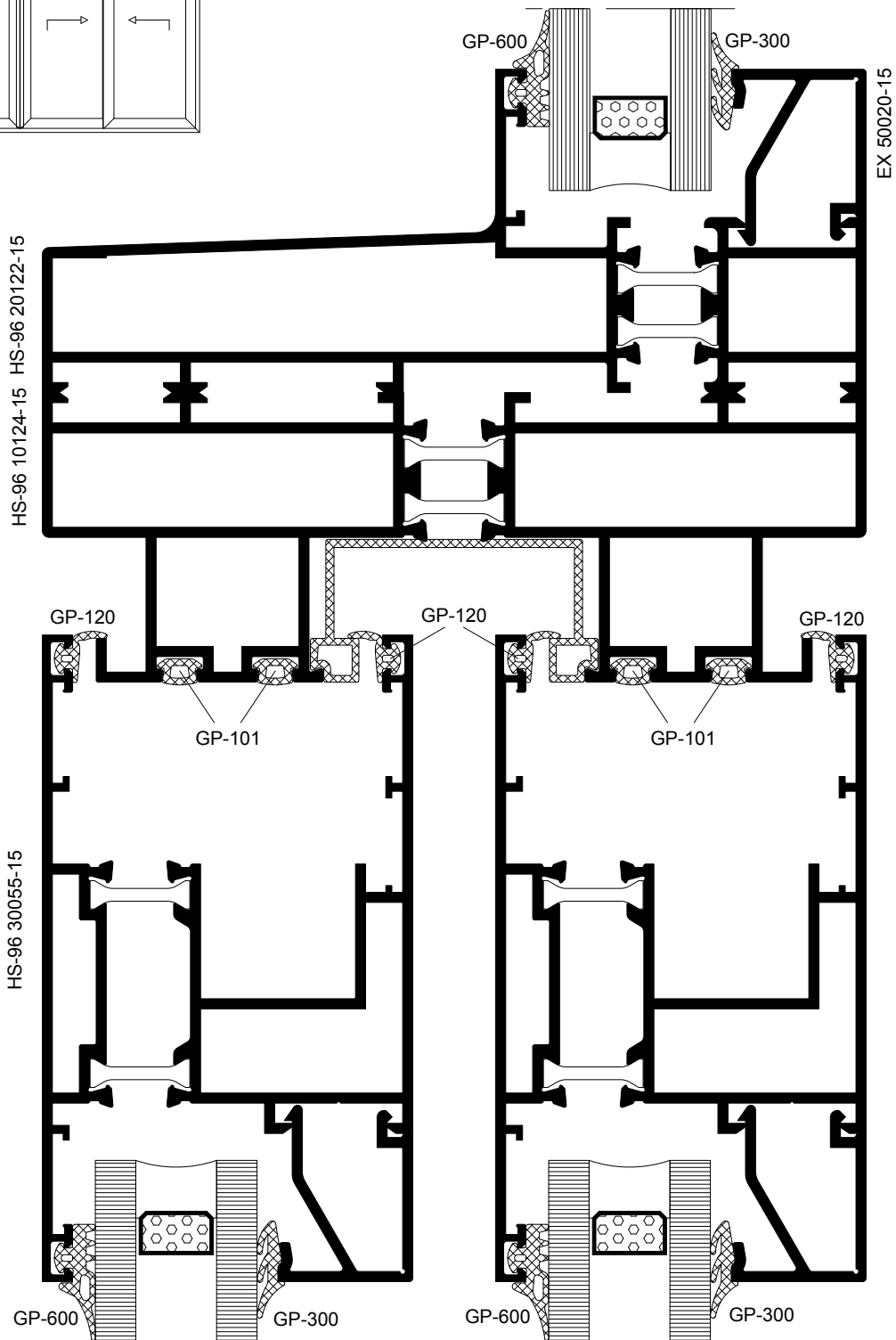
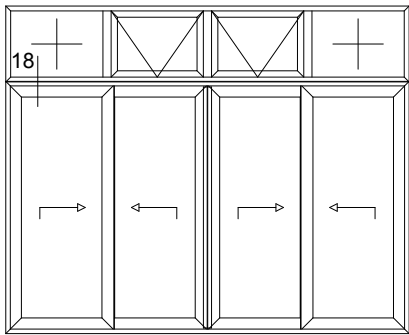

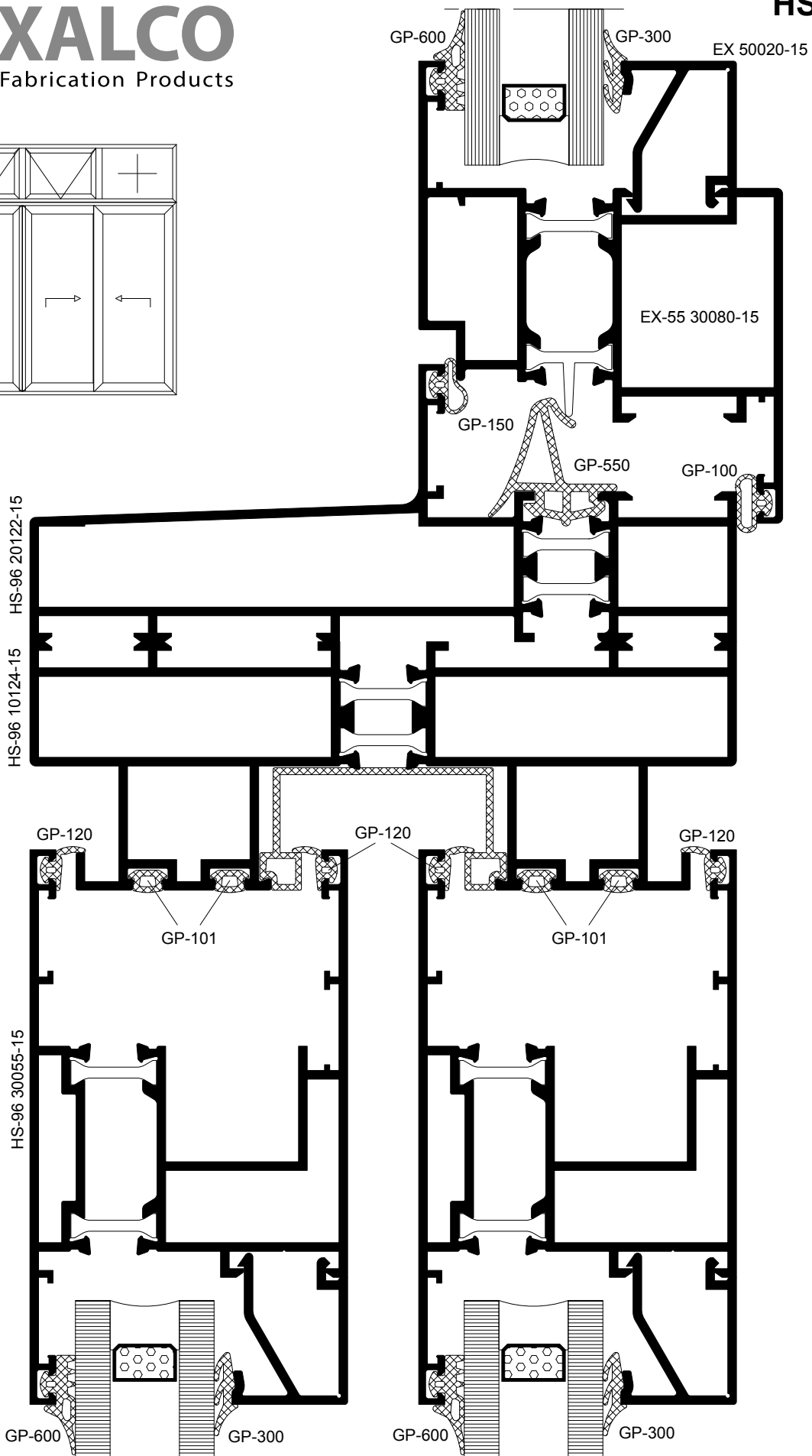
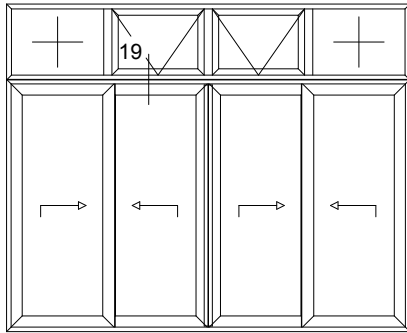

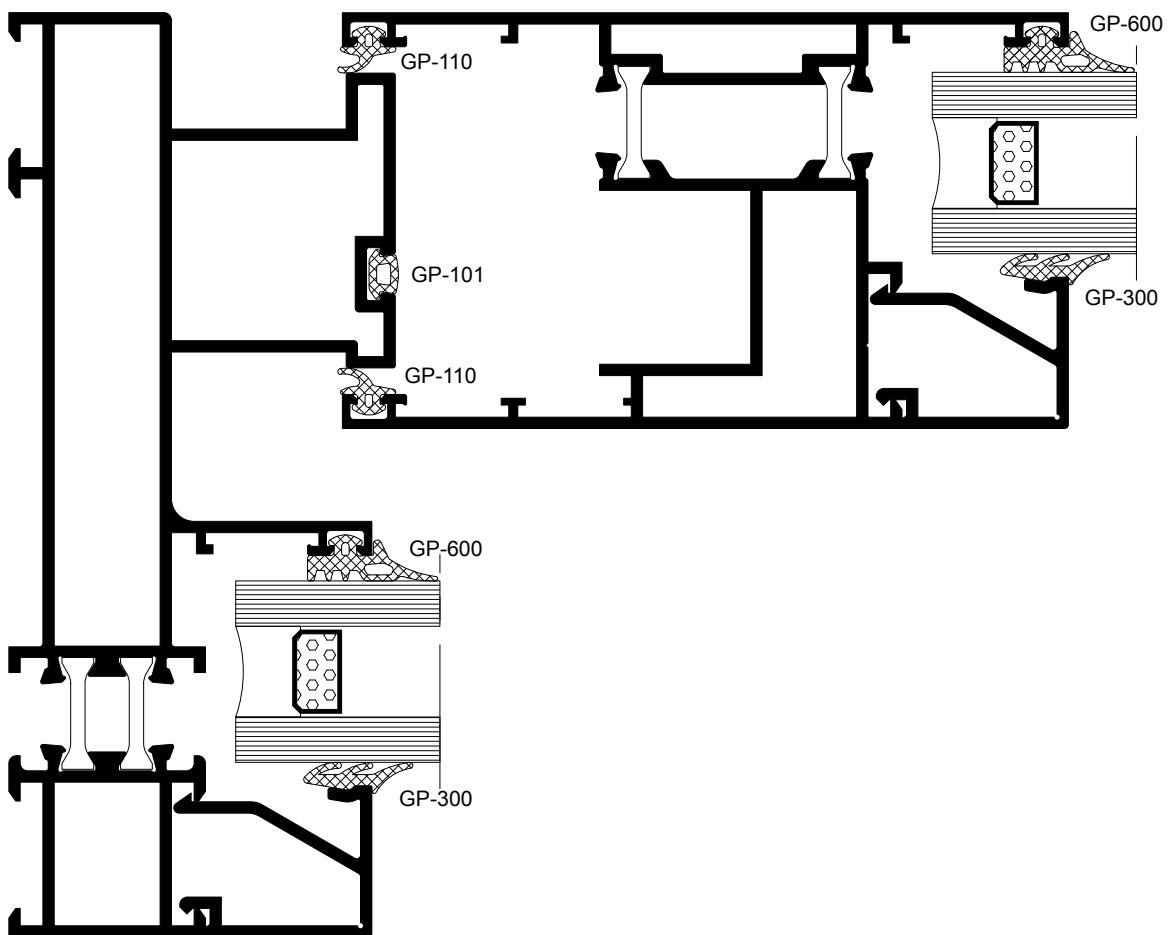
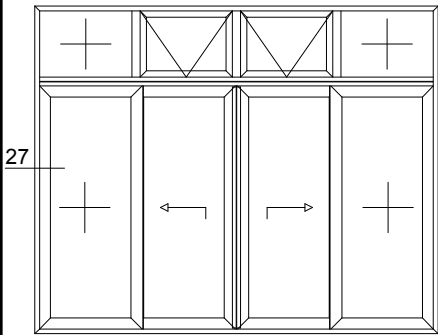

HS-96 12122-15

EX 50020-15

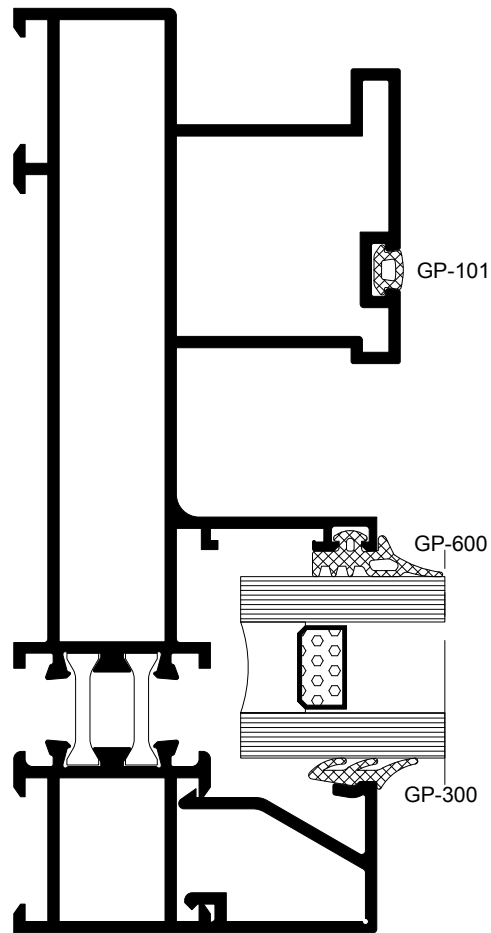
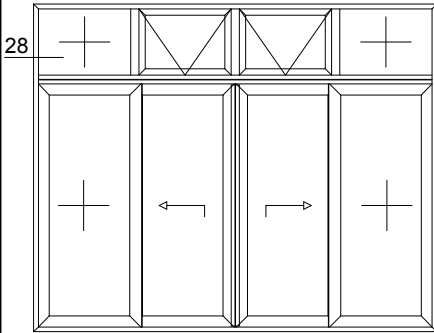

HS-96 12122-15

EX 50020-15

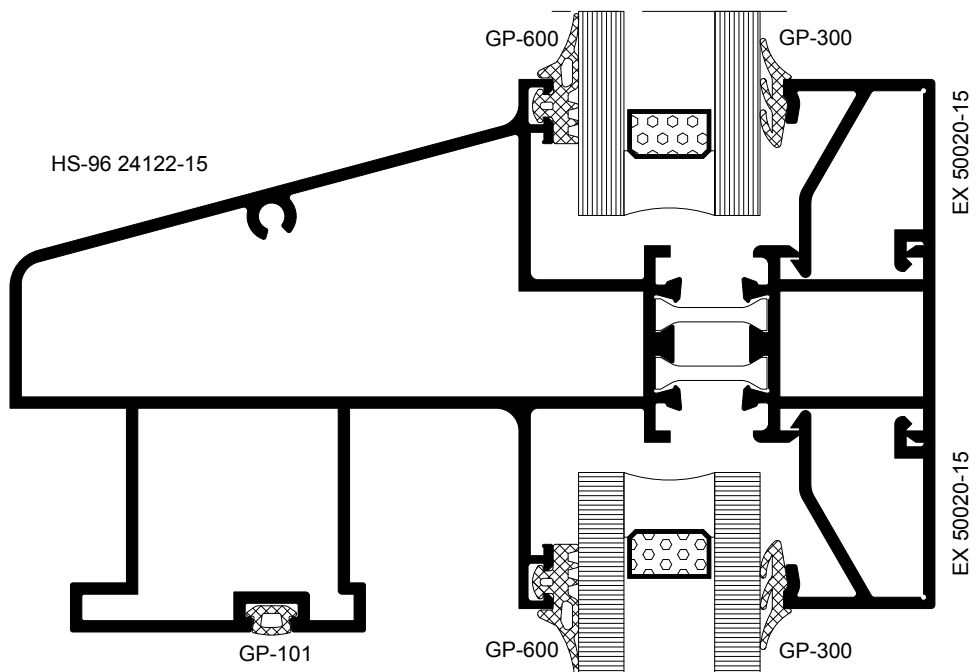
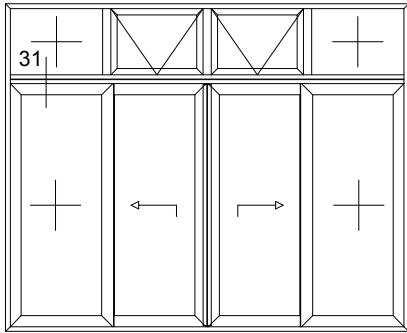



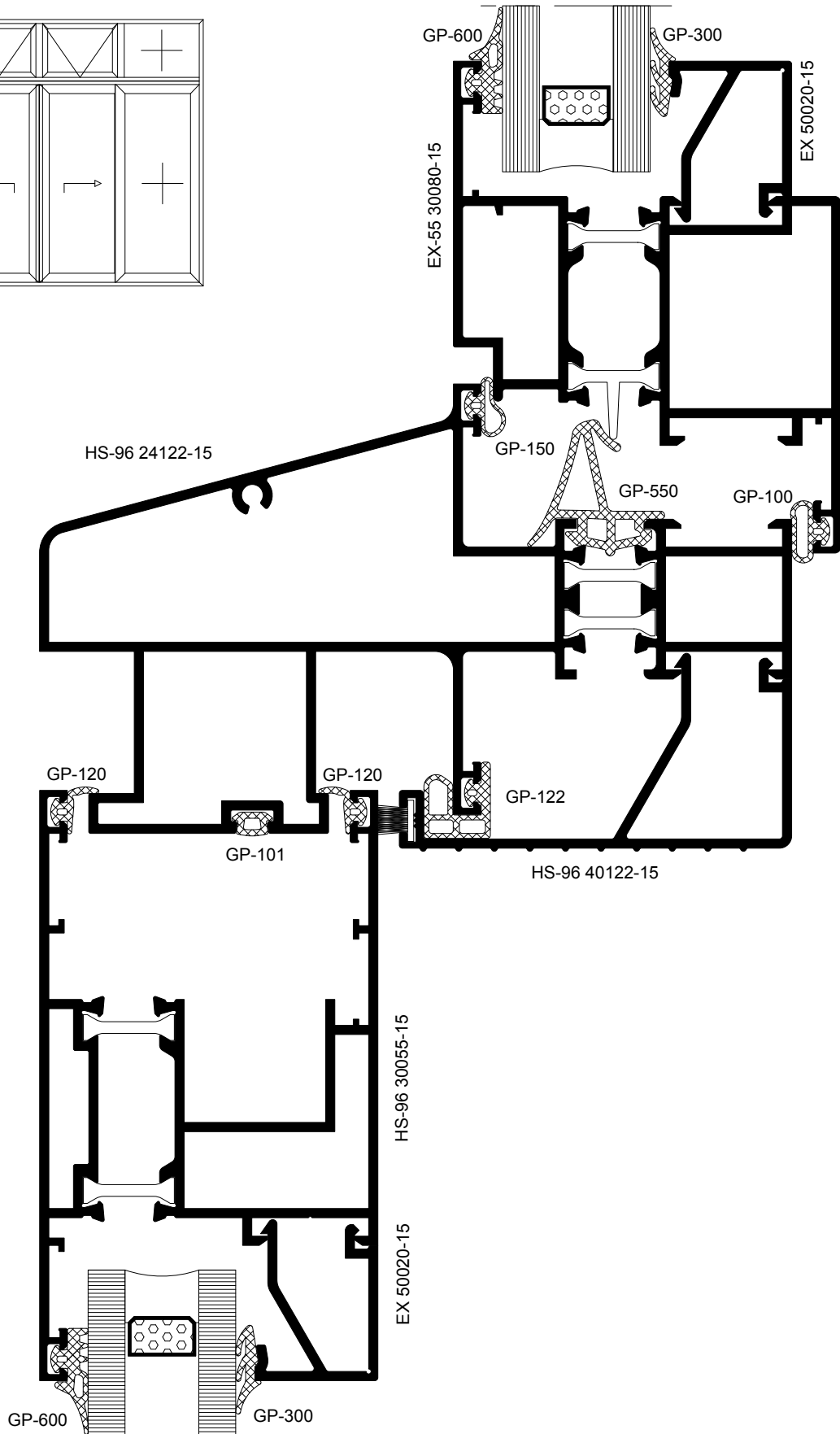
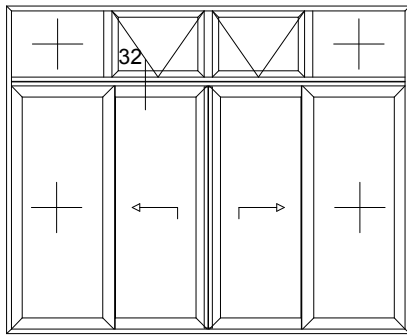

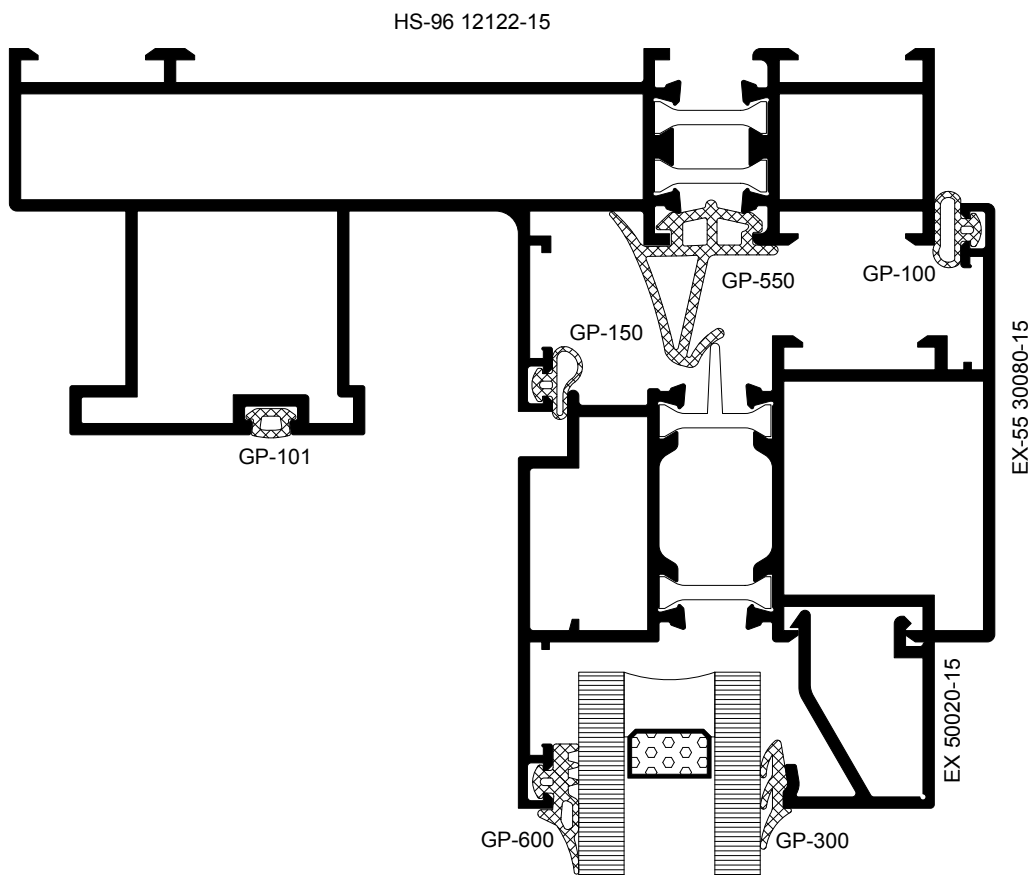
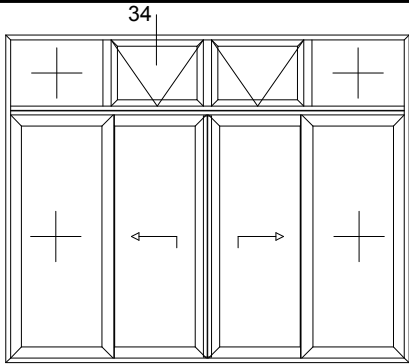

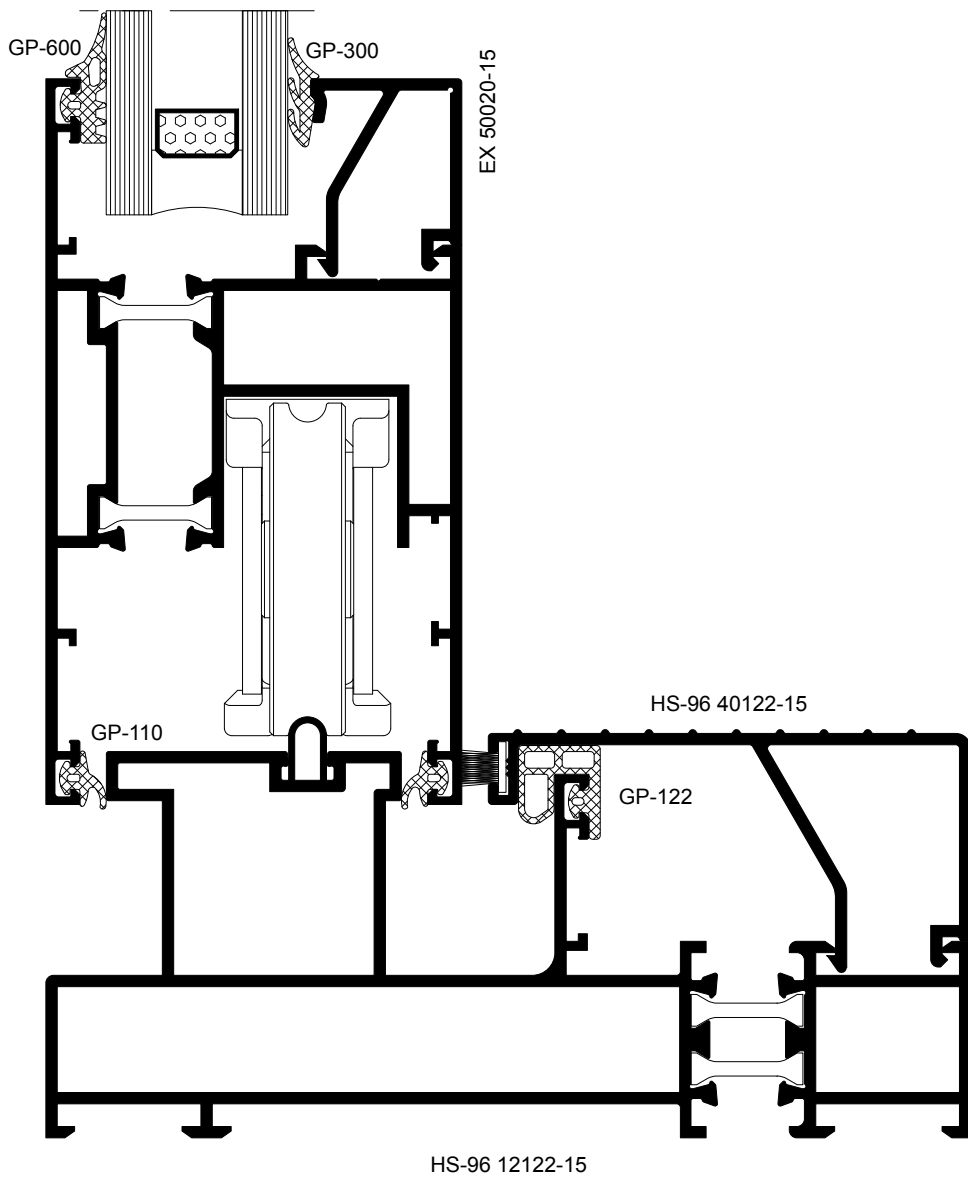
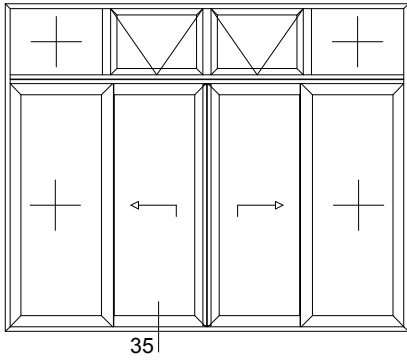

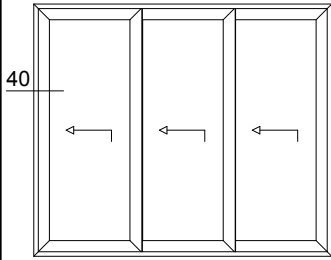

HS-96 30055-15

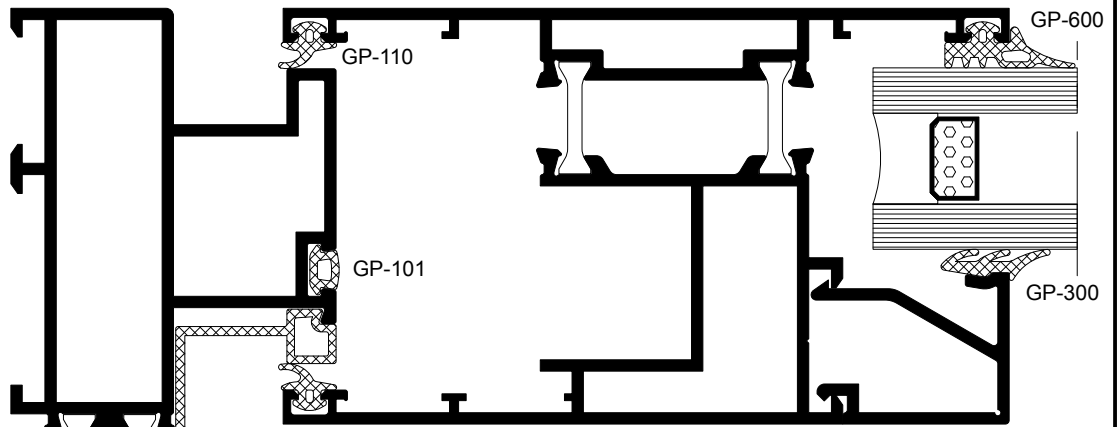

HS-96 30055-15

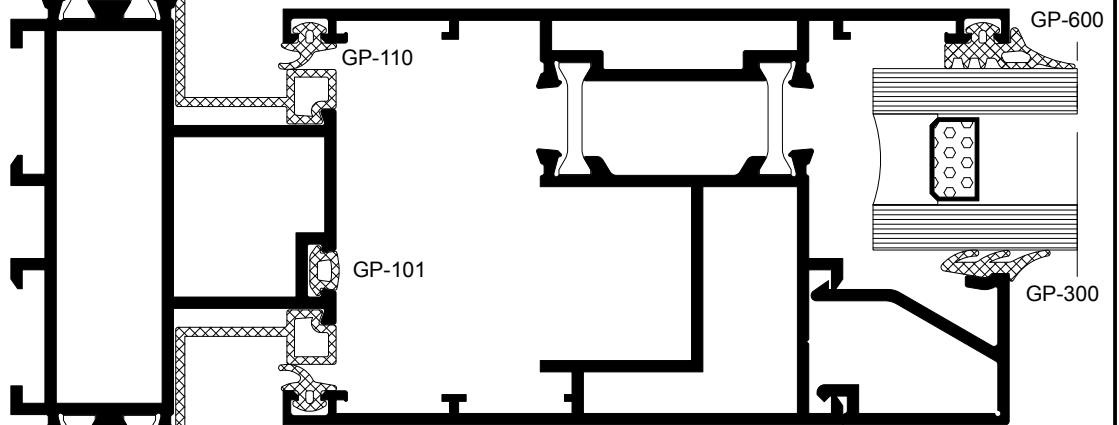

HS-96 10190-15

HS-96 30055-15

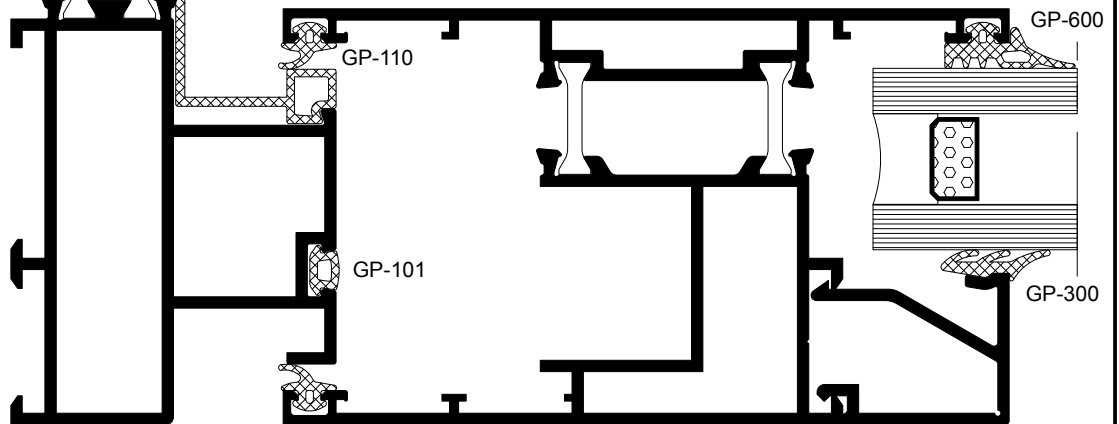

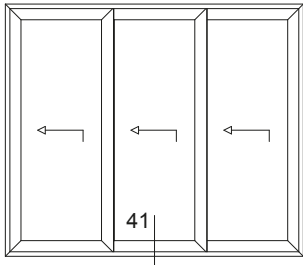

HS-96 30055-15

HS-96 10190-15

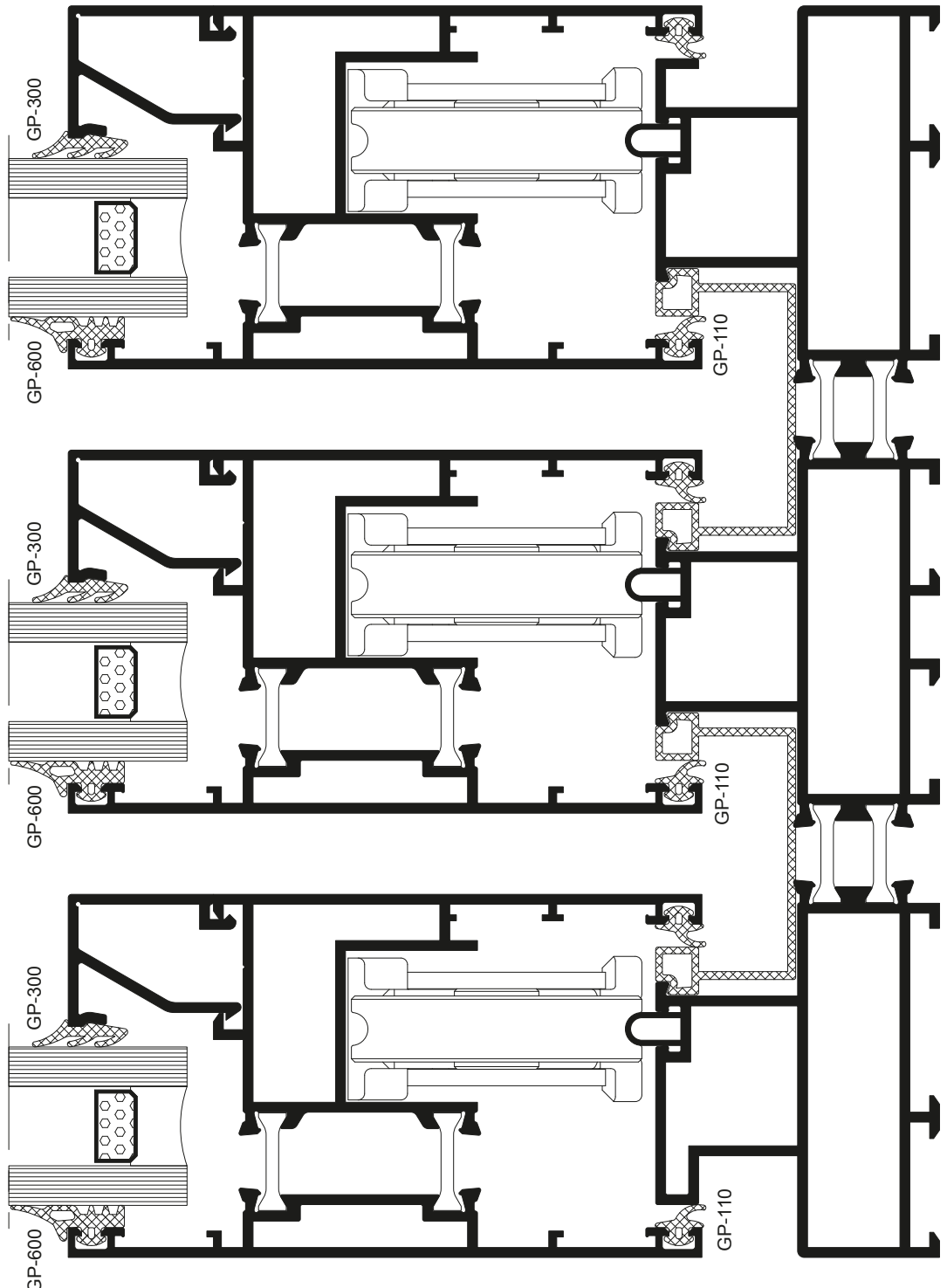

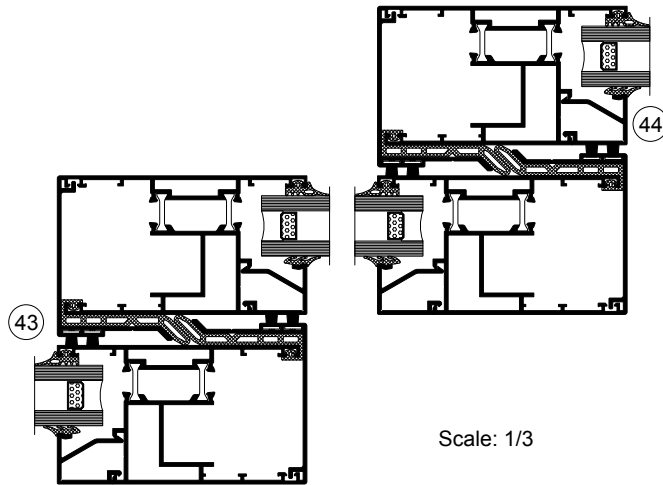
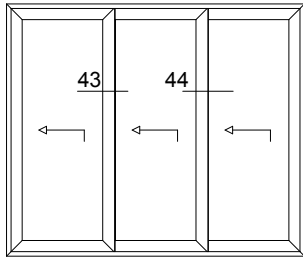

Scale: 1/3

HS-96 30055-15

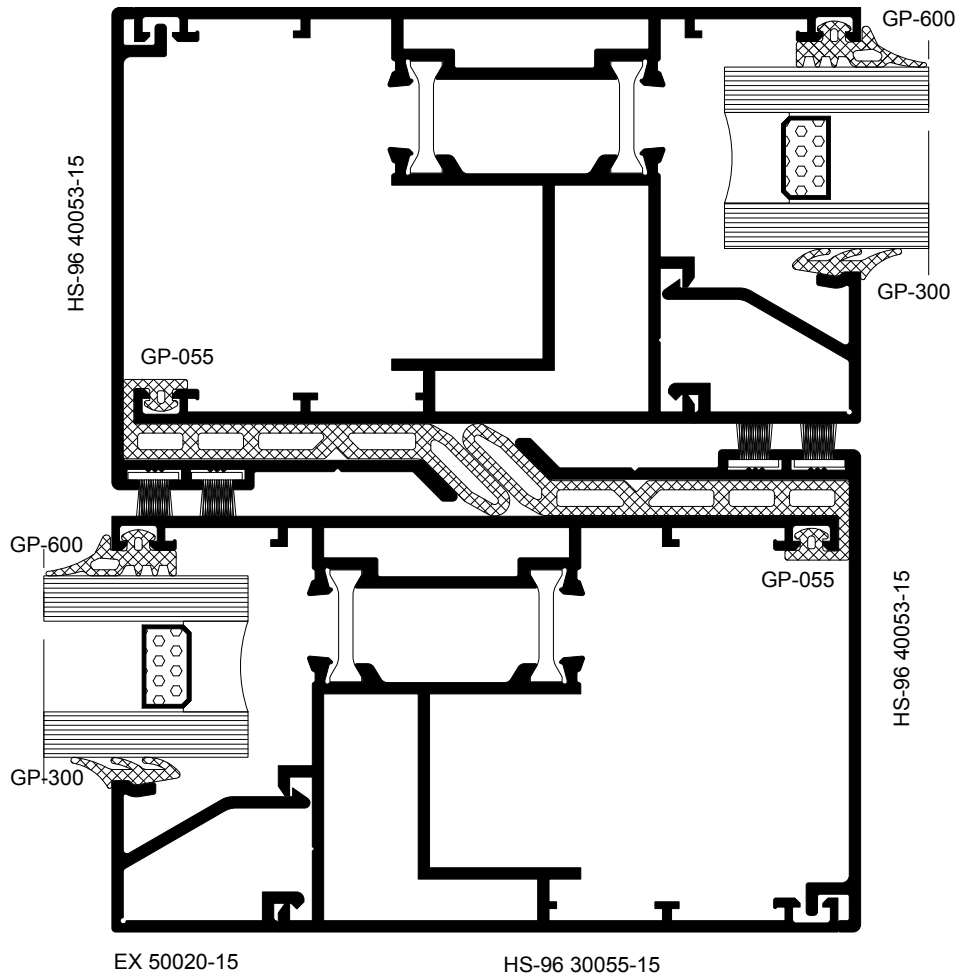

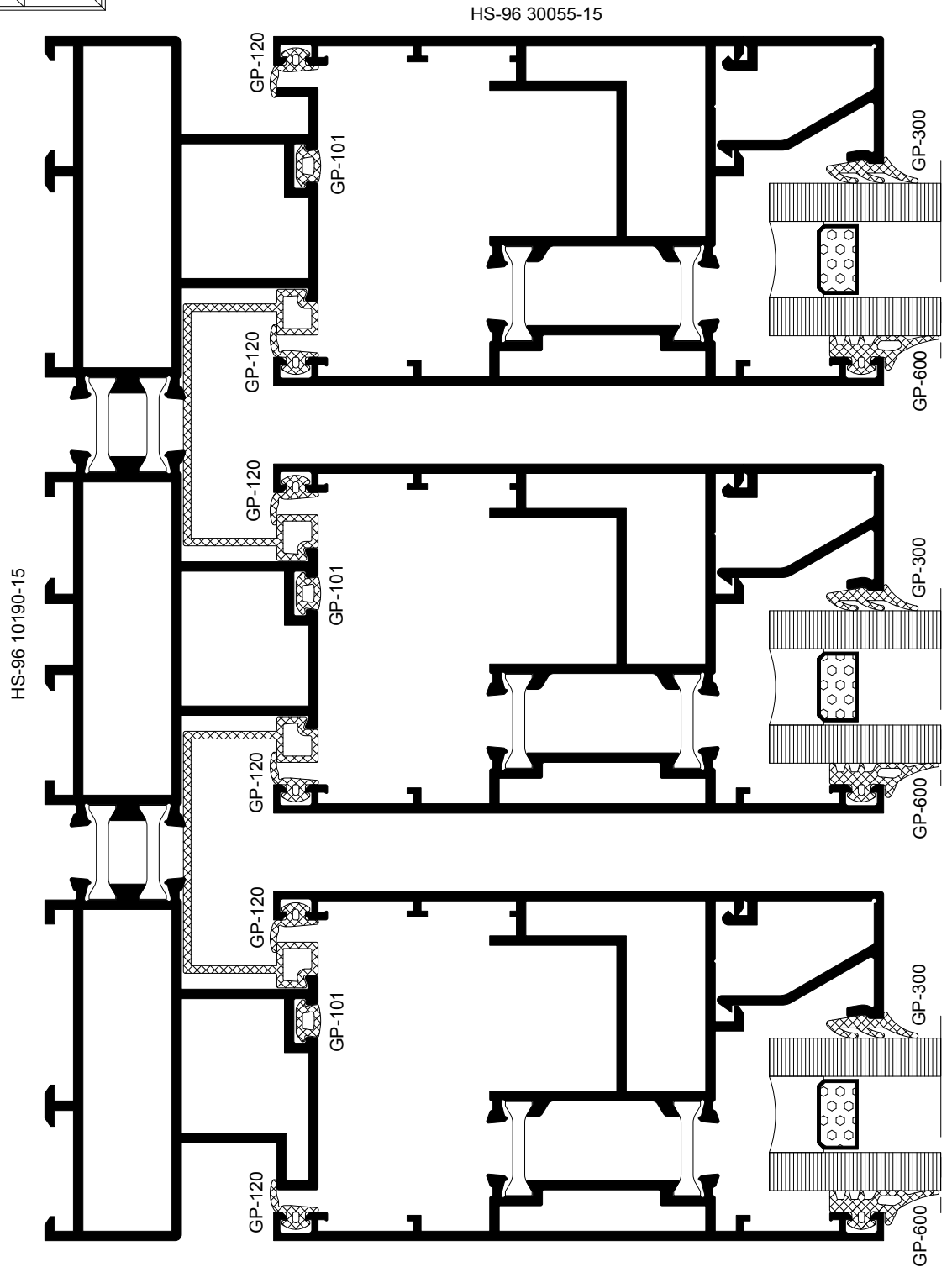
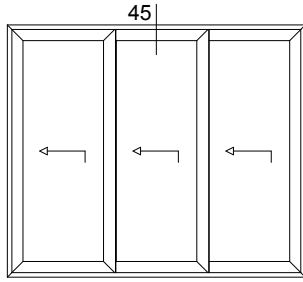

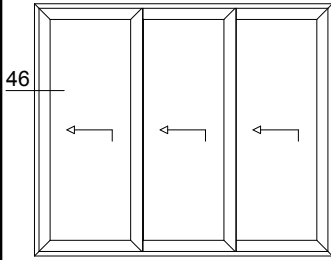

HS-96 30055-15

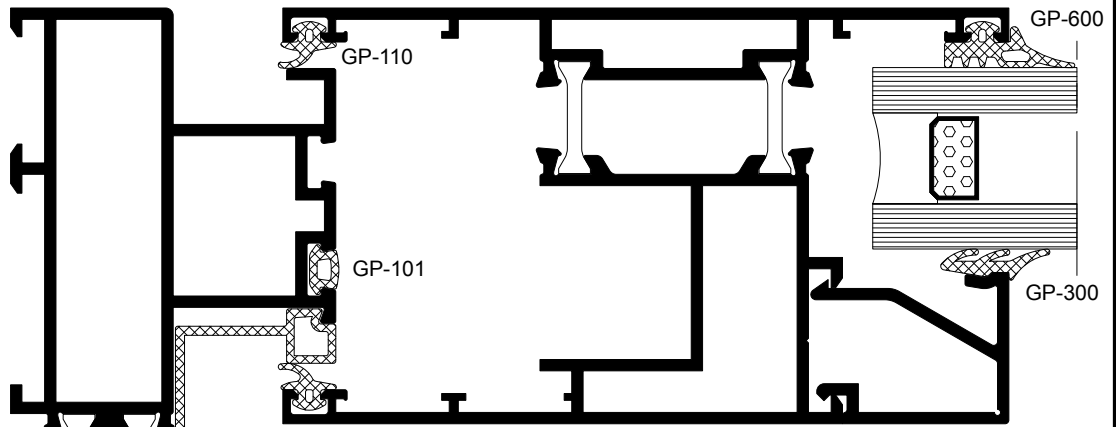

HS-96 30055-15

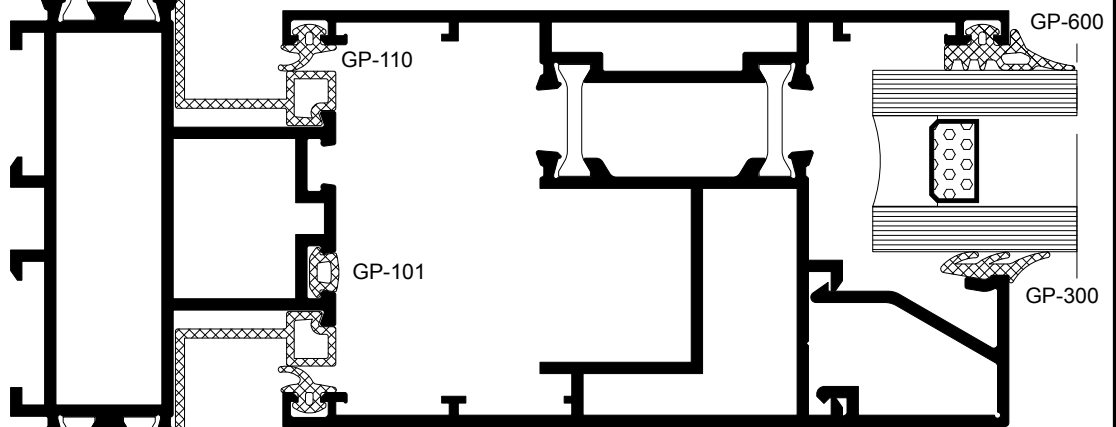

HS-96 10192-15

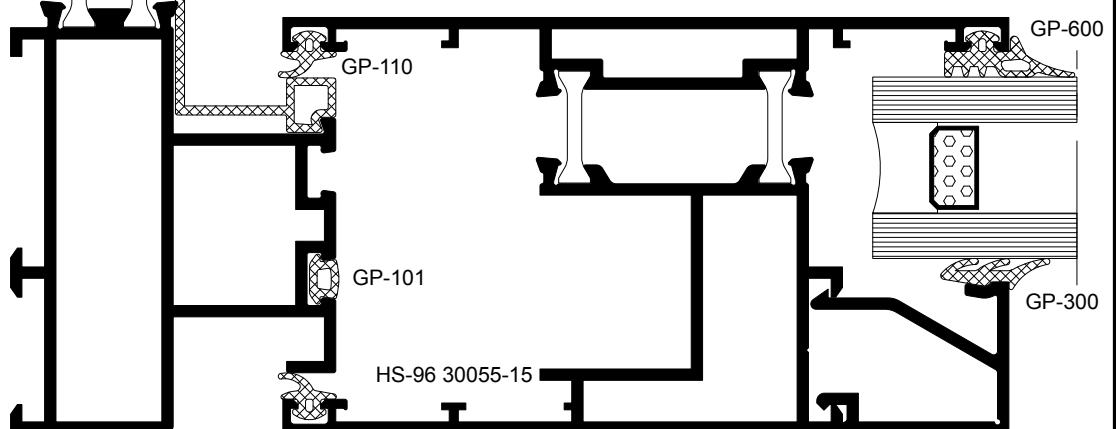



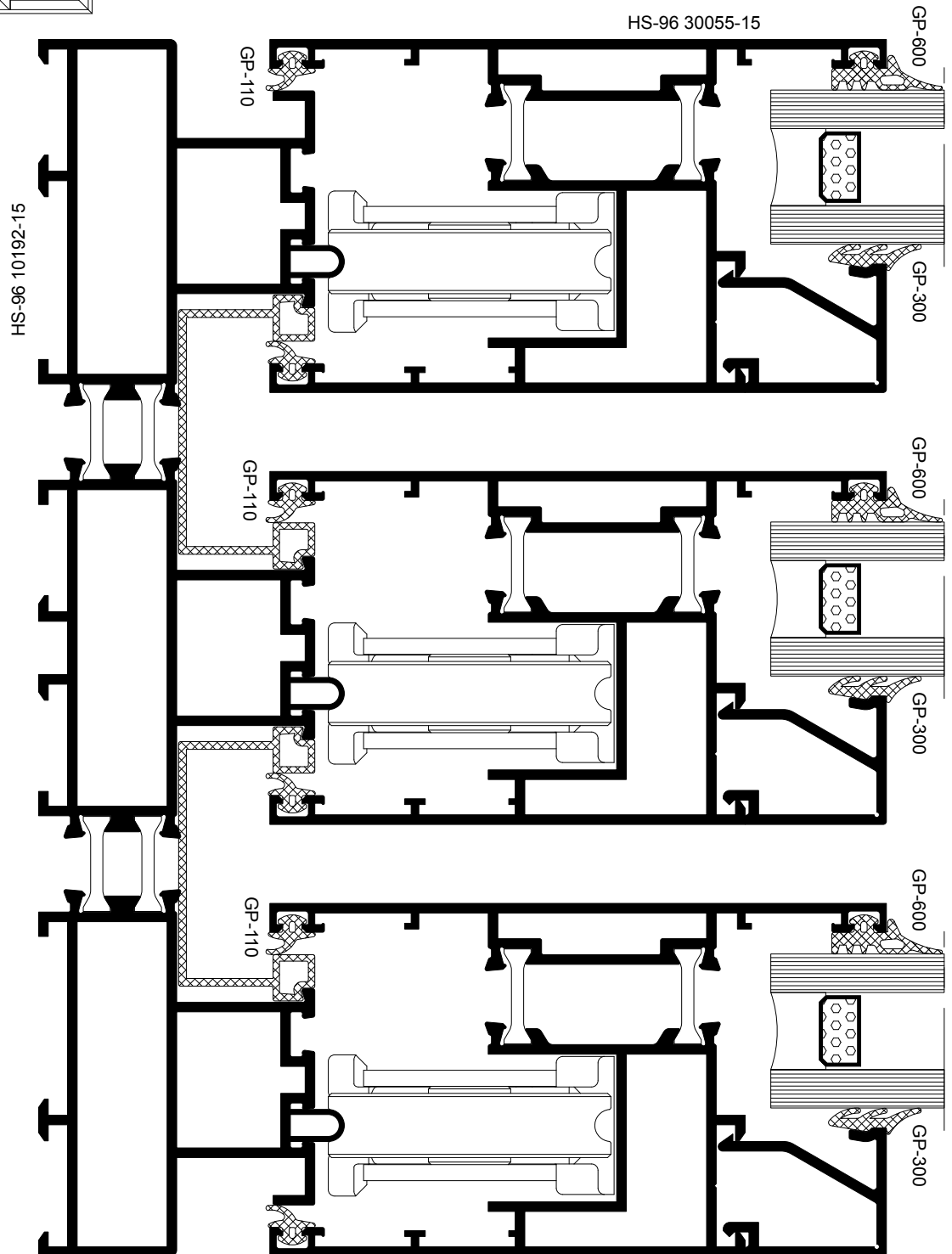
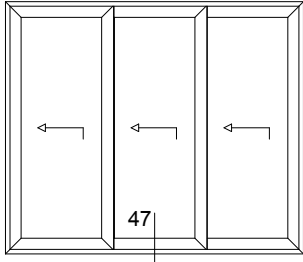

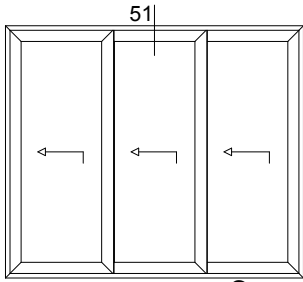

HS-96 30055-15

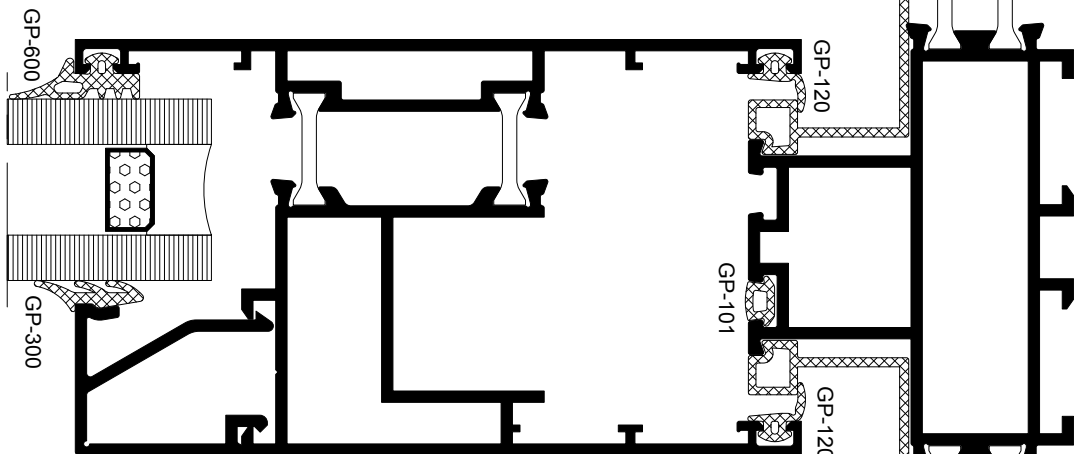
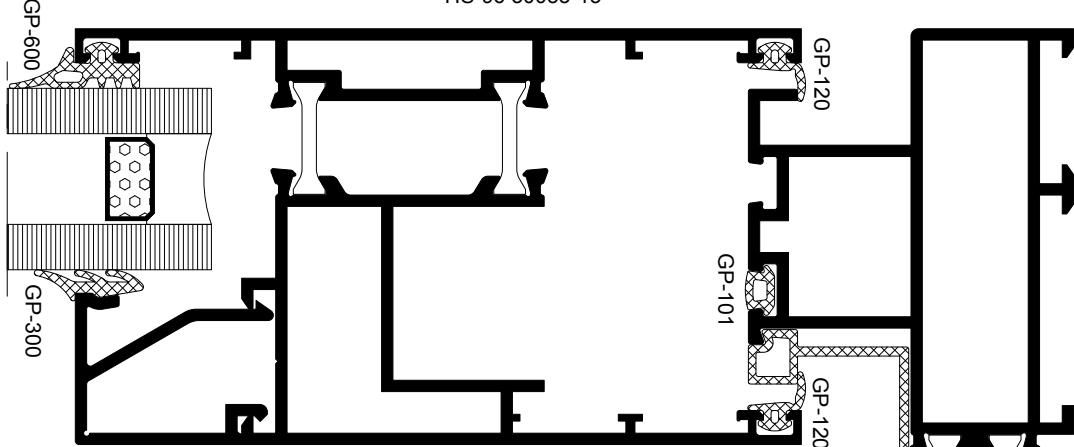

HS-96 10192-15

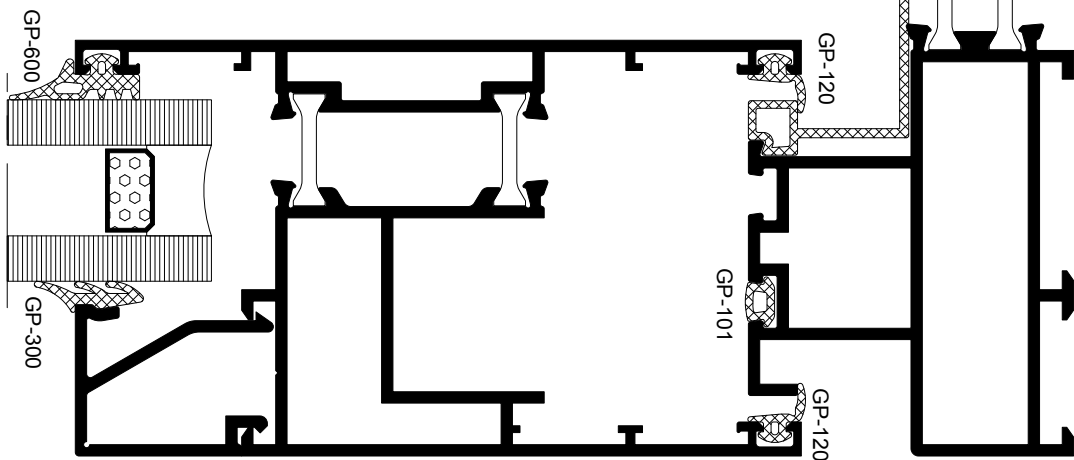



EX 40 030-00

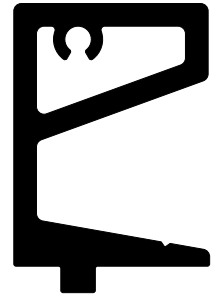

EX 40 032-00

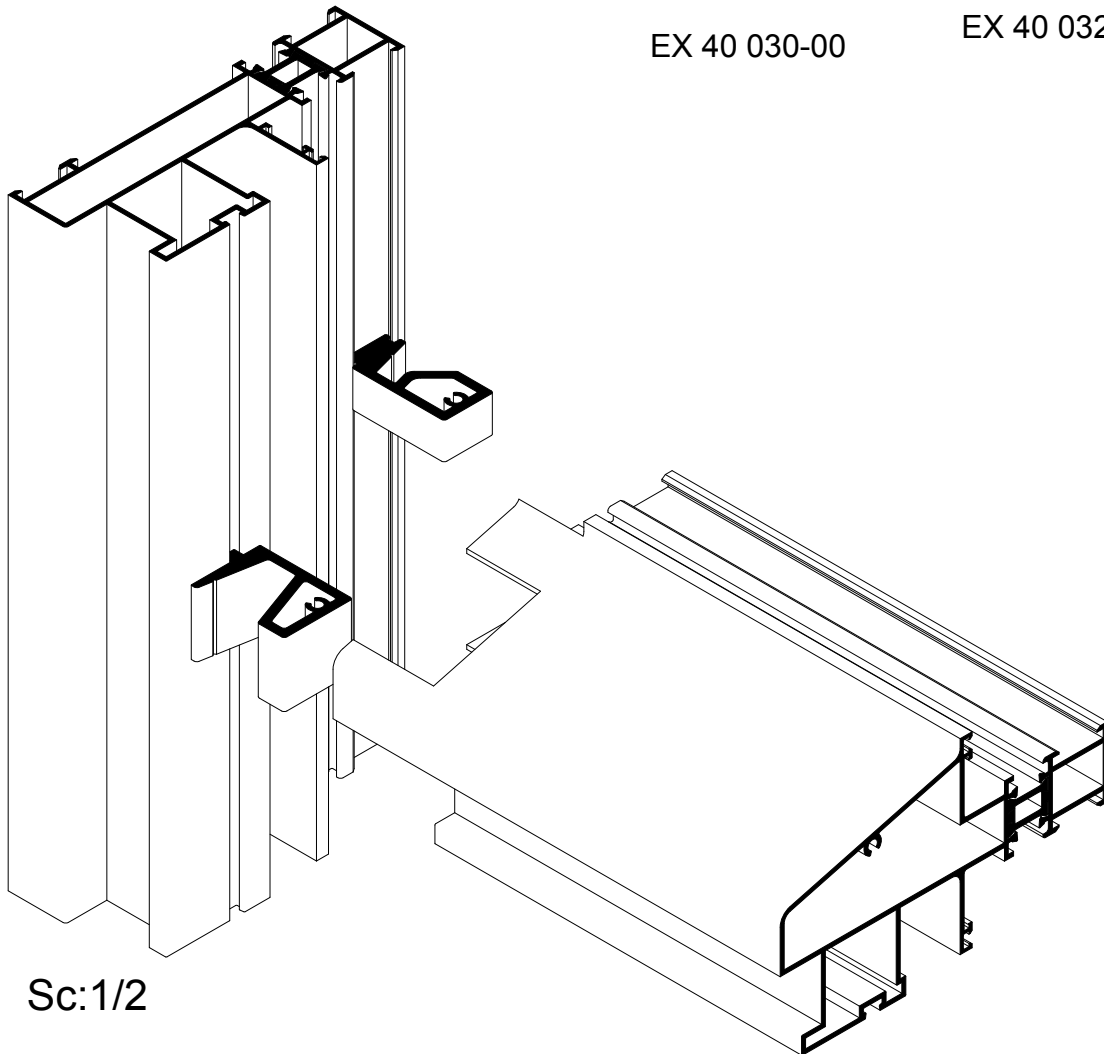

Sc:1/2

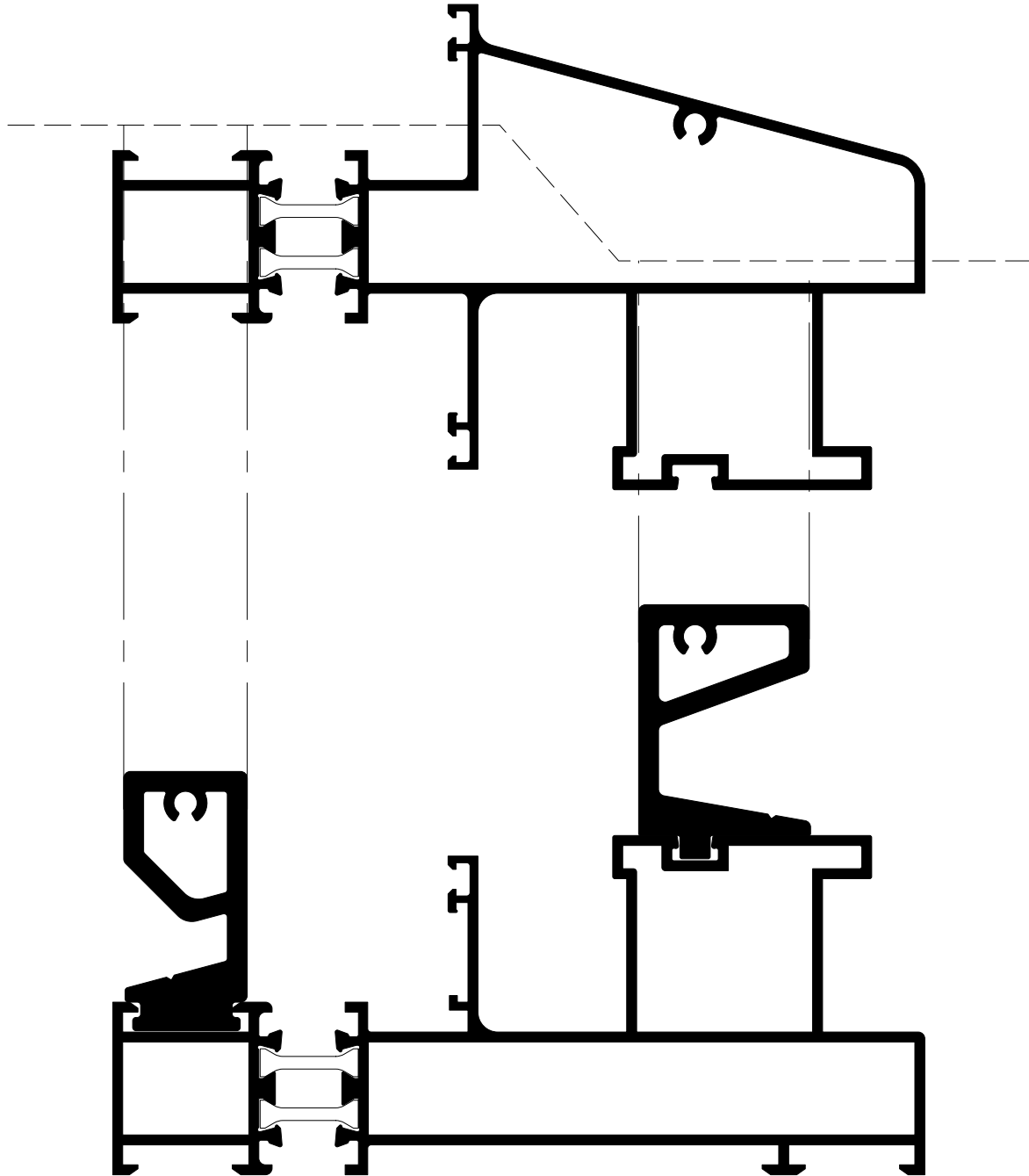



آدرس: زنجان، شهرک صنعتی شماره یک، خیابان پروفیسور ثبوتی، روبروی خیابان آذر جنوبی  
تلفن: ۴ - ۳۳۲۲ ۱۲۶۳ - ۰۲۴  
نمبر: ۱۲۶۵ - ۳۳۲۲ - ۰۲۴

**Add:** Professor sabouti St., No.1 Industrial Zone, Zanjan, iran

**Phone:** +9824 3222 1263 - 4

**Fax:** +9824 3222 1265

[www.exalaluminium.com](http://www.exalaluminium.com)

[info@exalaluminium.com](mailto:info@exalaluminium.com)