

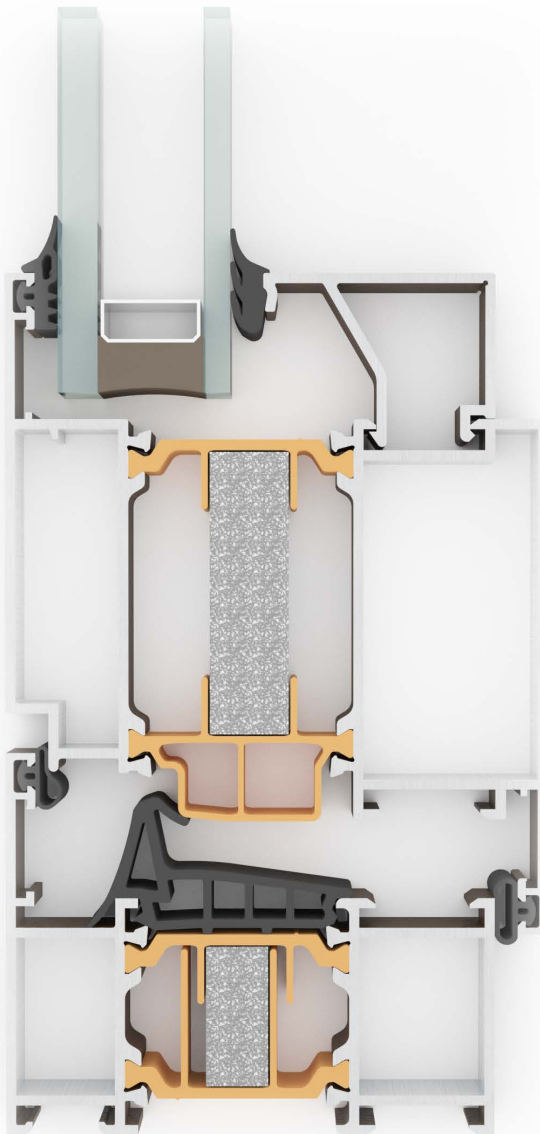

Aluminium Fabrication Products

**Door & Window System Technical Catalog**

کاتالوگ فنی سیستم های در و پنجره





# EXALCO

Aluminium Fabrication Products

- Made
- in
- IRAN

# EX74

## درو پنجره (سیستم لولایی) Door & Window

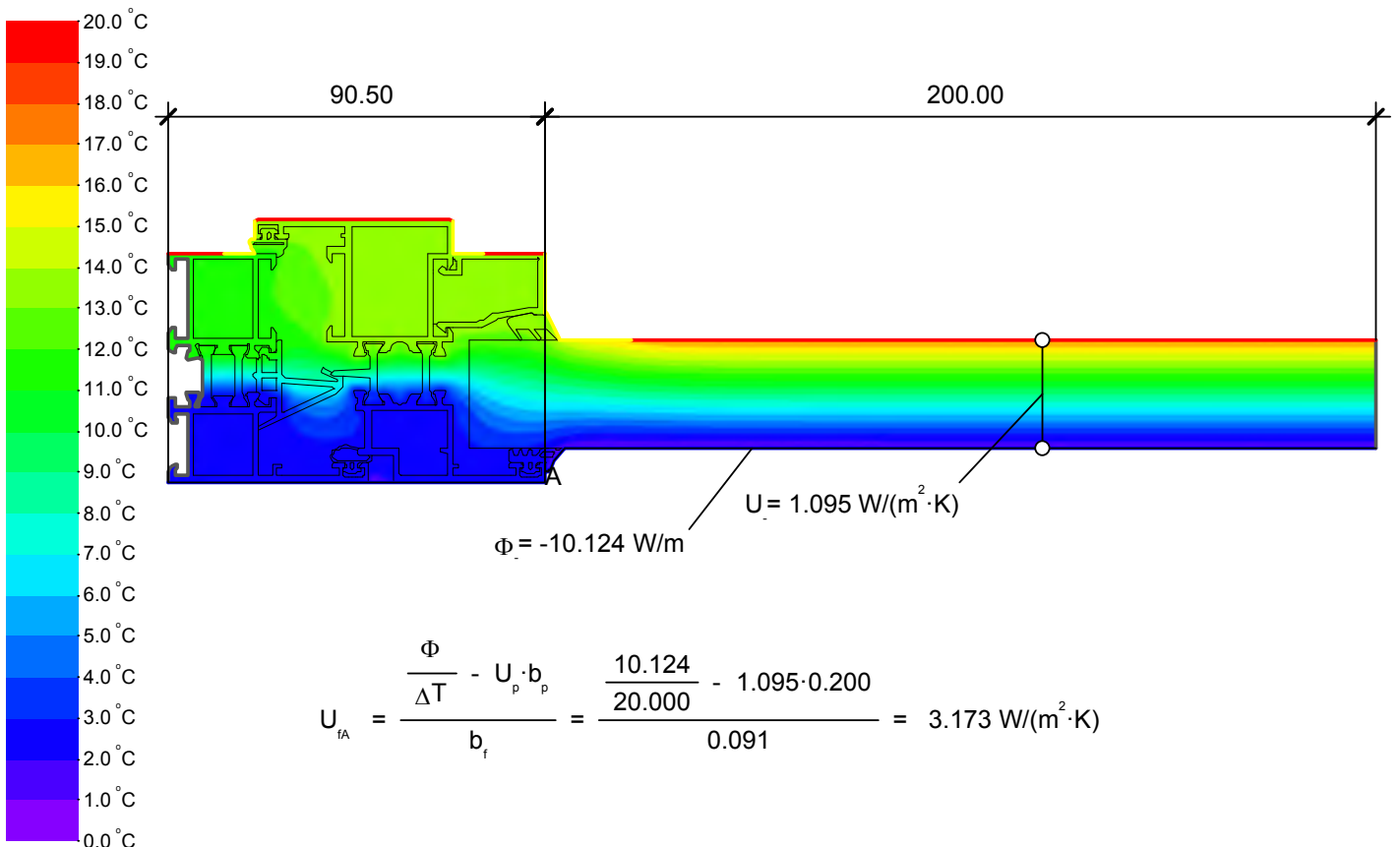
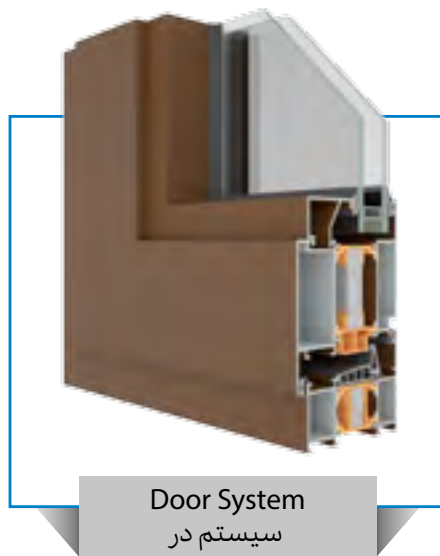

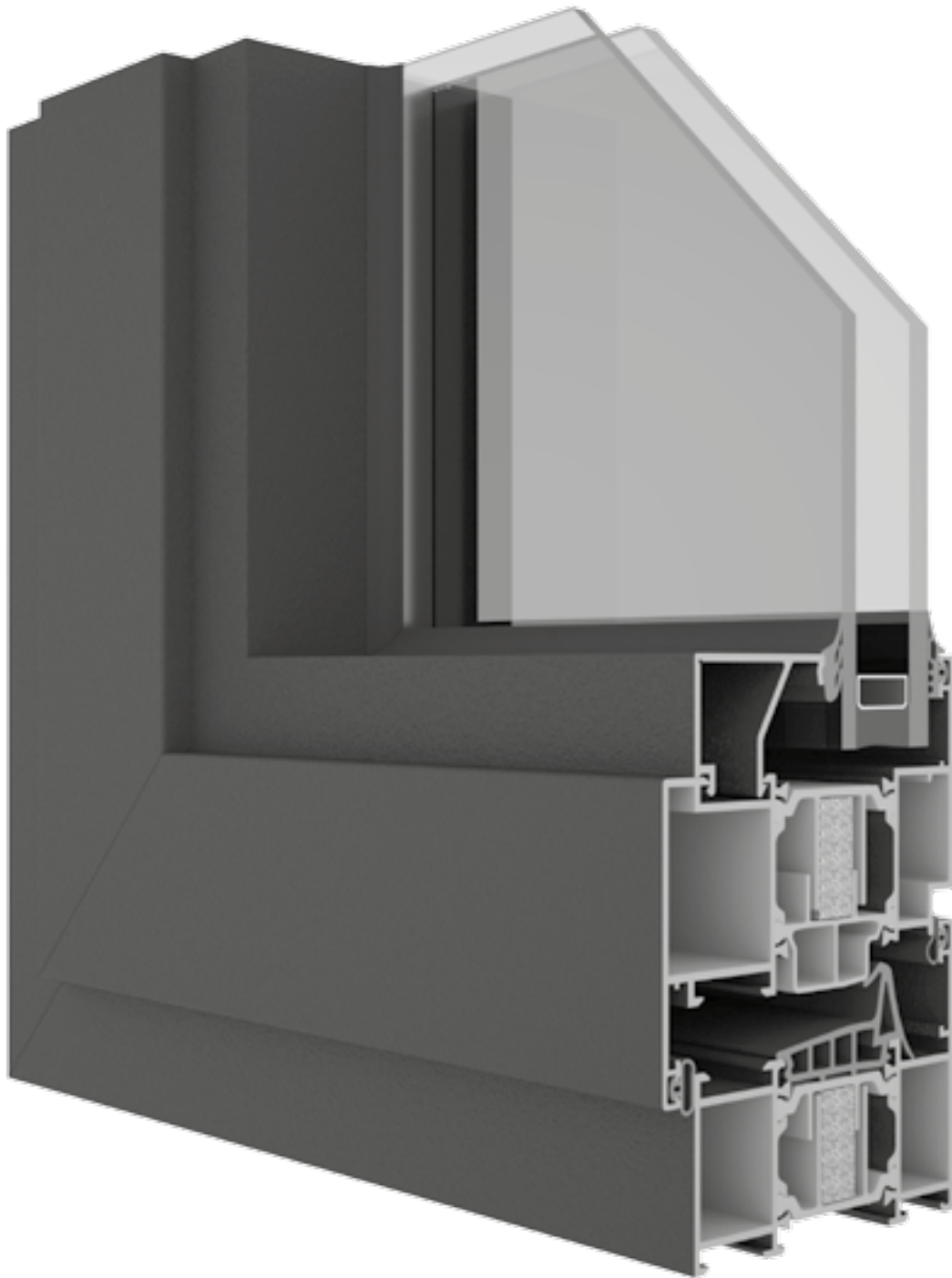

Profile No.	Weight (kg/m)	Static Value
کد پروفیل	وزن پروفیل	Jx (cm <sup>4</sup> ) Jy (cm <sup>4</sup> )
EX-74 10048-15	1.294 kg/m	30.99 / 4.90
EX-74 10058-15	1.503 kg/m	36.37 / 10.61
EX-74 10078-15	1.861 kg/m	47.57 / 31.09
EX-74 15058-15	1.620 kg/m	44.56 / 12.77

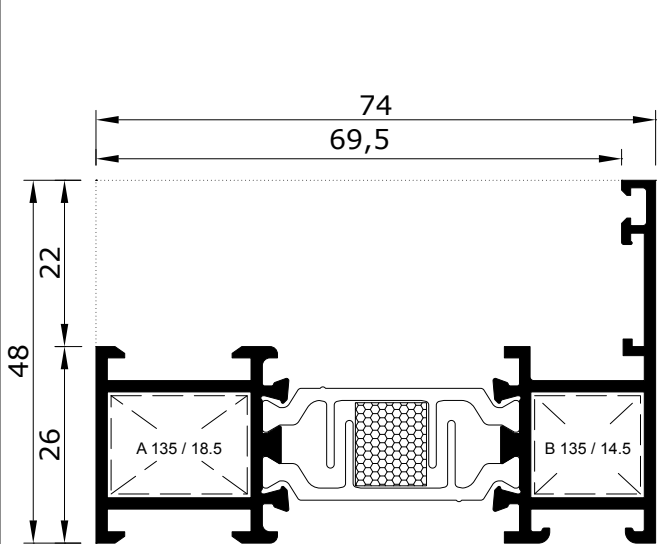

EX-74 10048-15

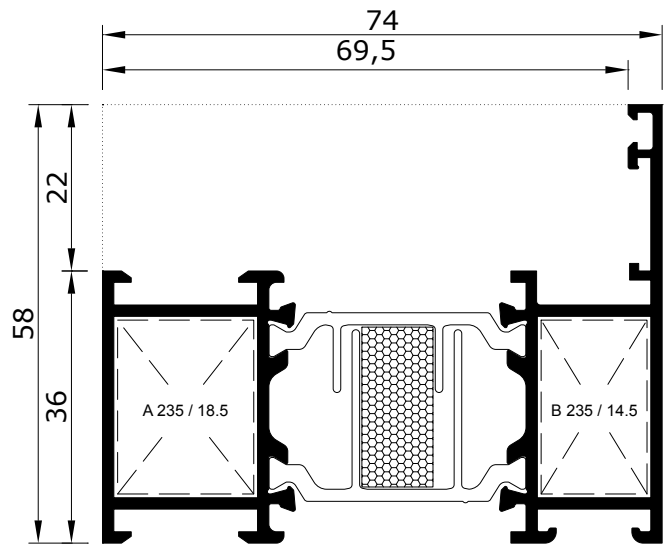

EX-74 10058-15

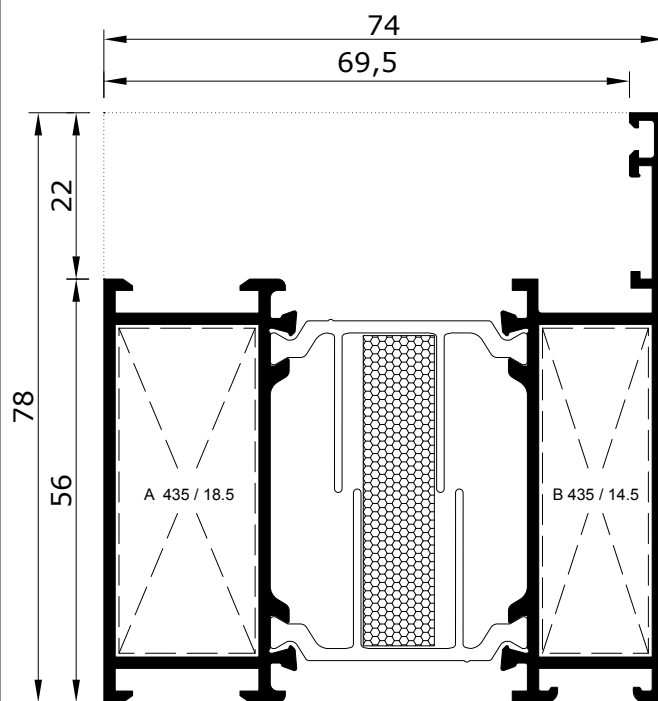

EX-74 10078-15

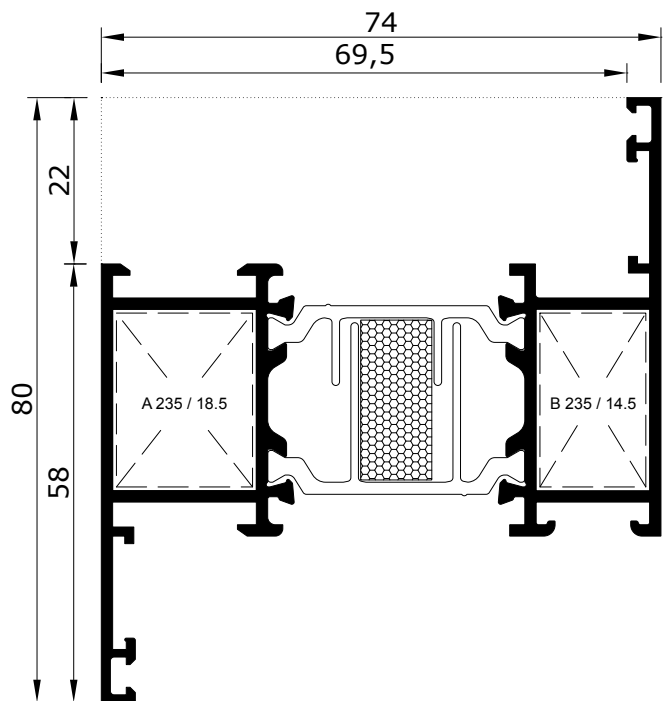

EX-74 15058-15

Profile No.	Weight (kg/m)	Static Value
کد پروفیل	وزن پروفیل	Jx (cm <sup>4</sup> ) Jy (cm <sup>4</sup> )
EX-74 14048-15	1.557 kg/m	50.47 / 7.12
EX-74 14058-15	1.766 kg/m	58.38 / 14.13

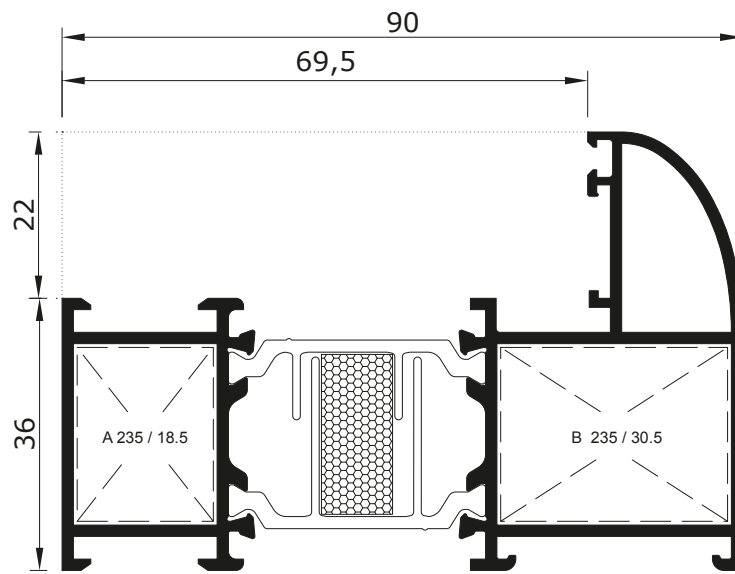

EX-74 14058-15

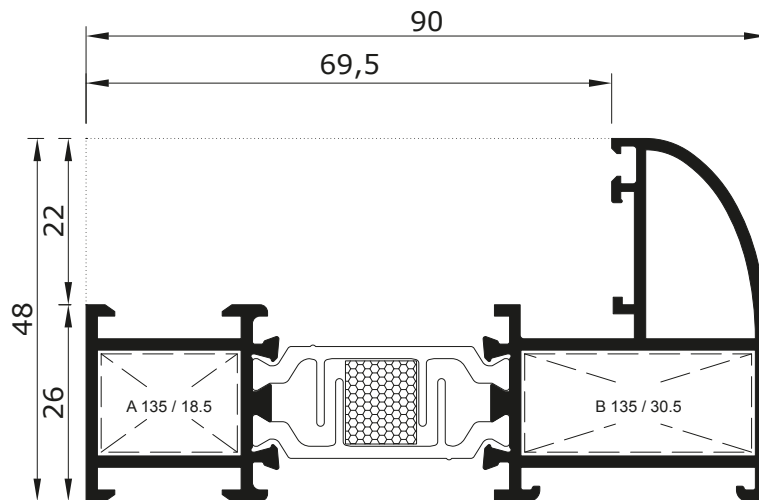

EX-74 14048-15

Profile No.	Weight (kg/m)	Static Value
کد پروفیل	وزن پروفیل	Jx (cm <sup>4</sup> ) Jy (cm <sup>4</sup> )
EX-74 14078-15	2.125 kg/m	74.82 / 38.34

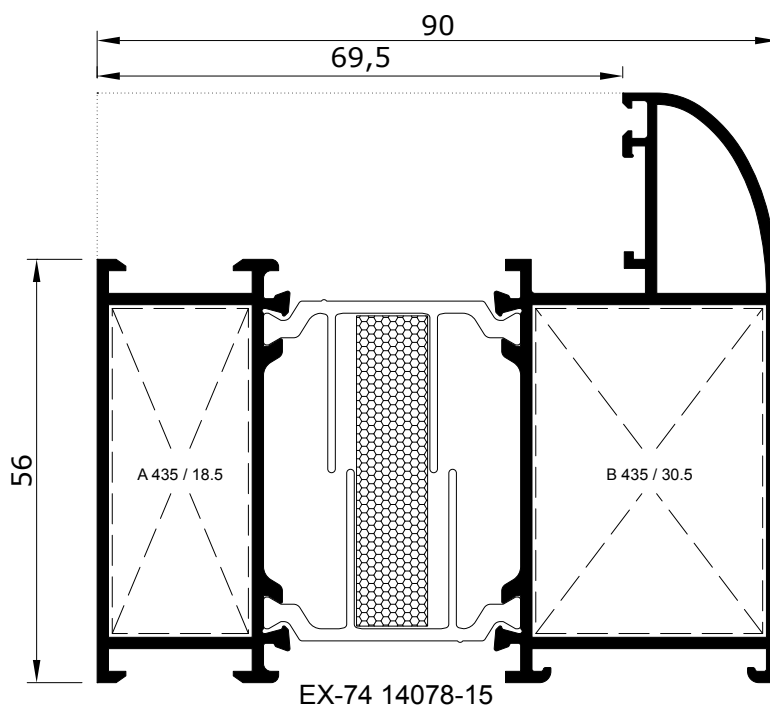

Profile No.	Weight (kg/m)	Static Value
کد پروفیل	وزن پروفیل	Jx (cm <sup>4</sup> ) Jy (cm <sup>4</sup> )
EX-74 20070-15	1.397 kg/m	34.53 / 8.29
EX-74 20080-15	1.606 kg/m	39.80 / 15.37
EX-74 20100-15	1.964 kg/m	49.90 / 39.92

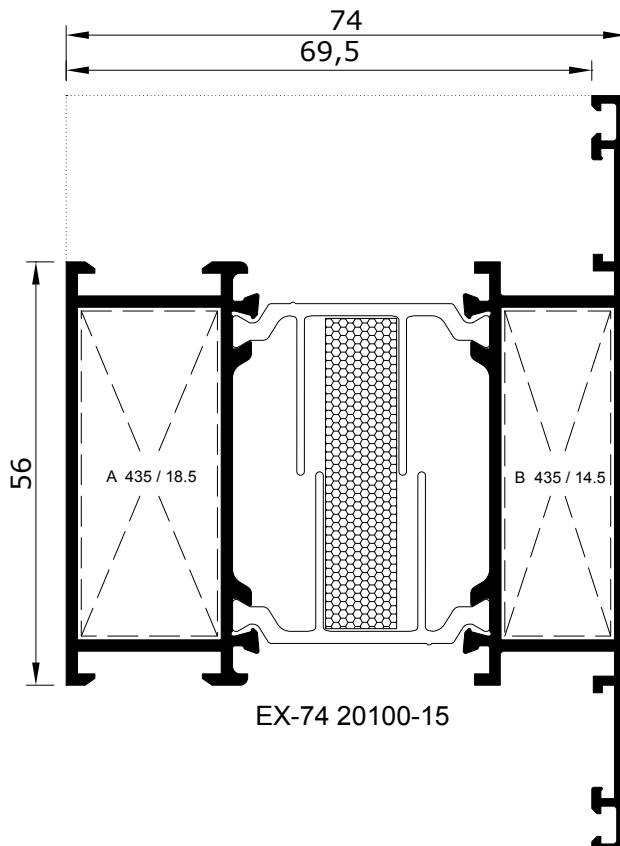
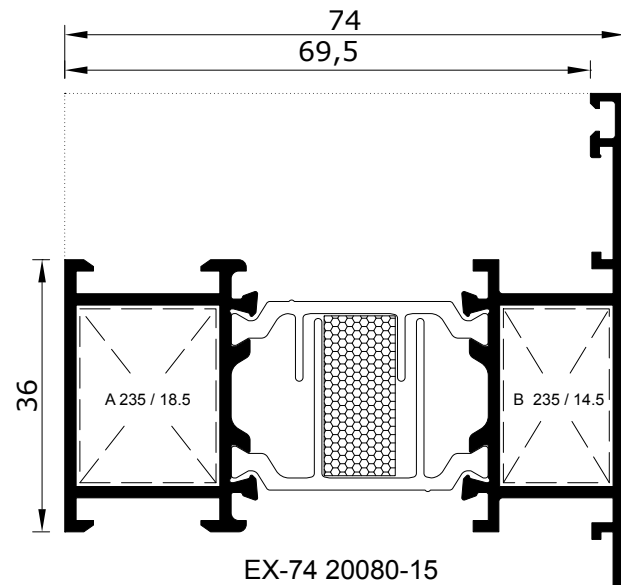
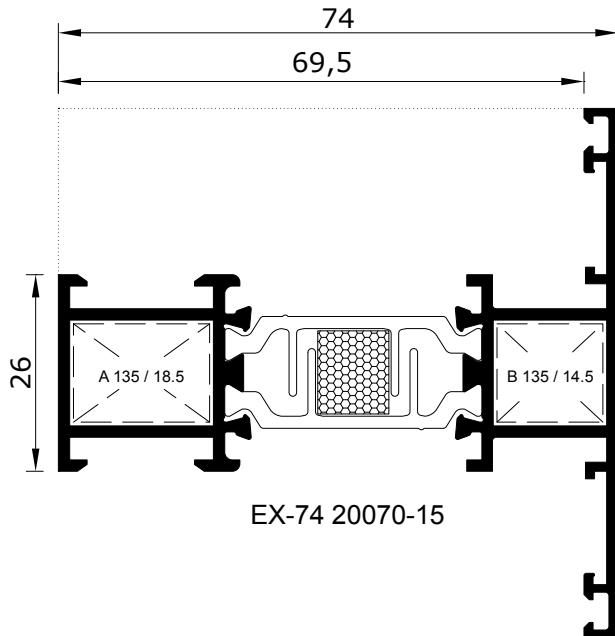



Profile No.	Weight (kg/m)	Static Value
کد پروفیل	وزن پروفیل	Jx (cm <sup>4</sup> ) Jy (cm <sup>4</sup> )
EX-74 20135-15	2.467 kg/m	66.96 / 121.90
EX-74 60135-15	2.584 kg/m	

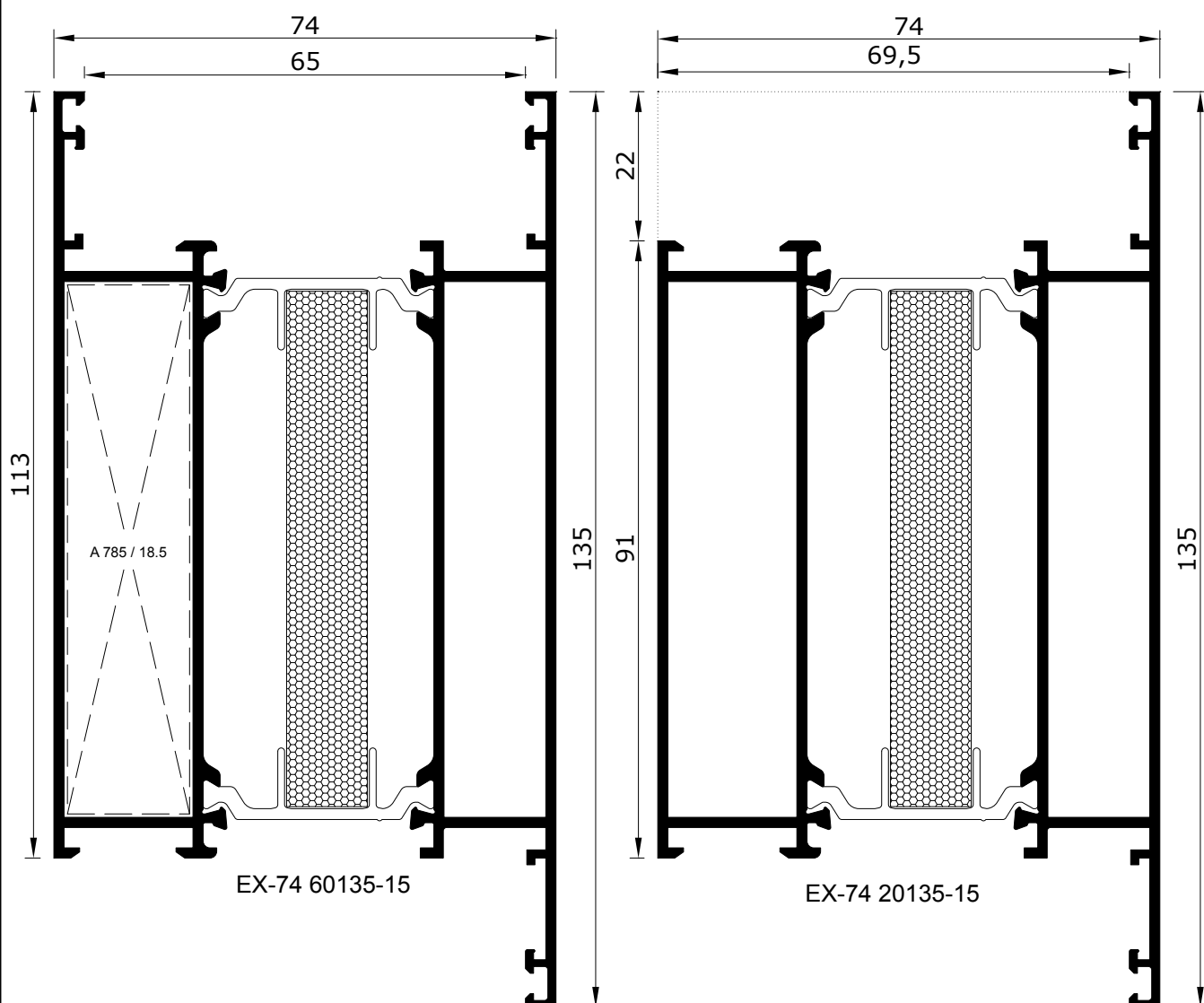

Profile No.	Weight (kg/m)	Static Value
کد پروفیل	وزن پروفیل	Jx (cm <sup>4</sup> ) Jy (cm <sup>4</sup> )
EX-74 30070-15	1.509 kg/m	
EX-74 30080-15	1.704 kg/m	

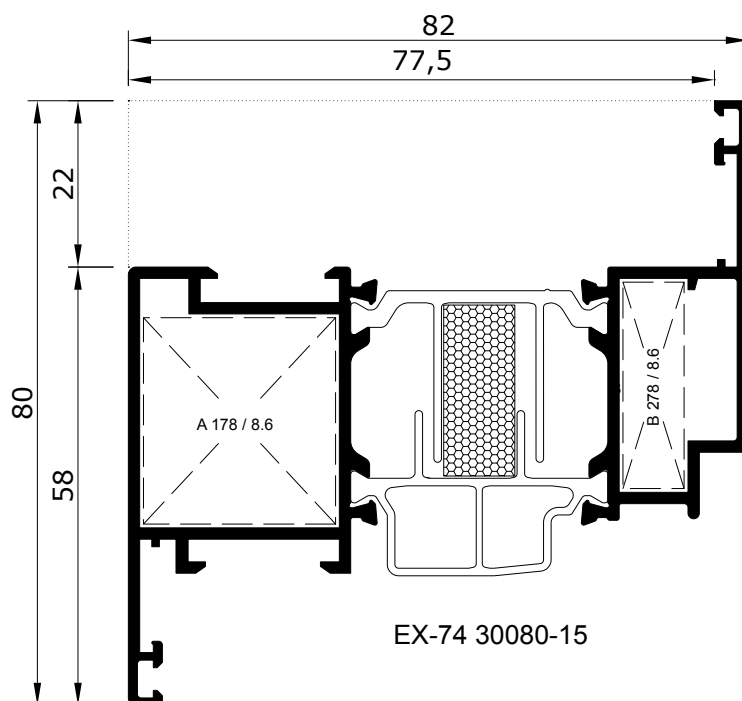
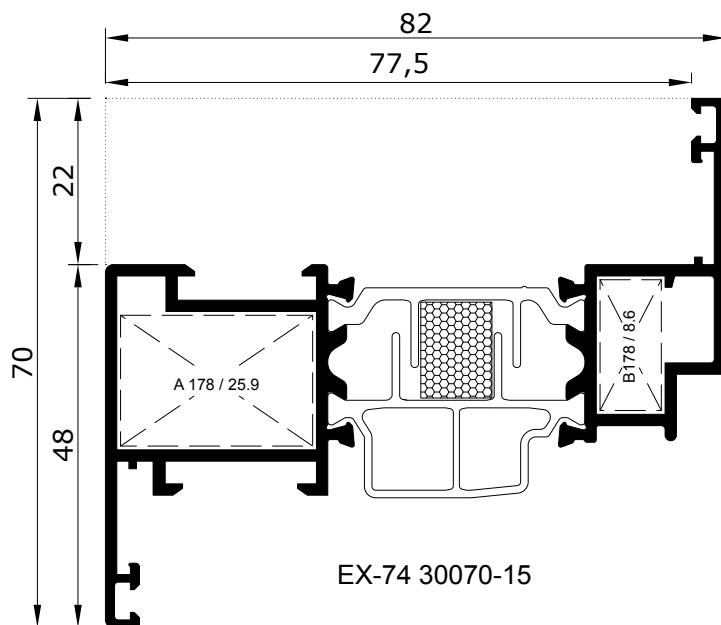

Profile No.	Weight (kg/m)	Static Value
کد پروفیل	وزن پروفیل	Jx (cm <sup>4</sup> ) Jy (cm <sup>4</sup> )
EX-74 30100-15	1.997 kg/m	

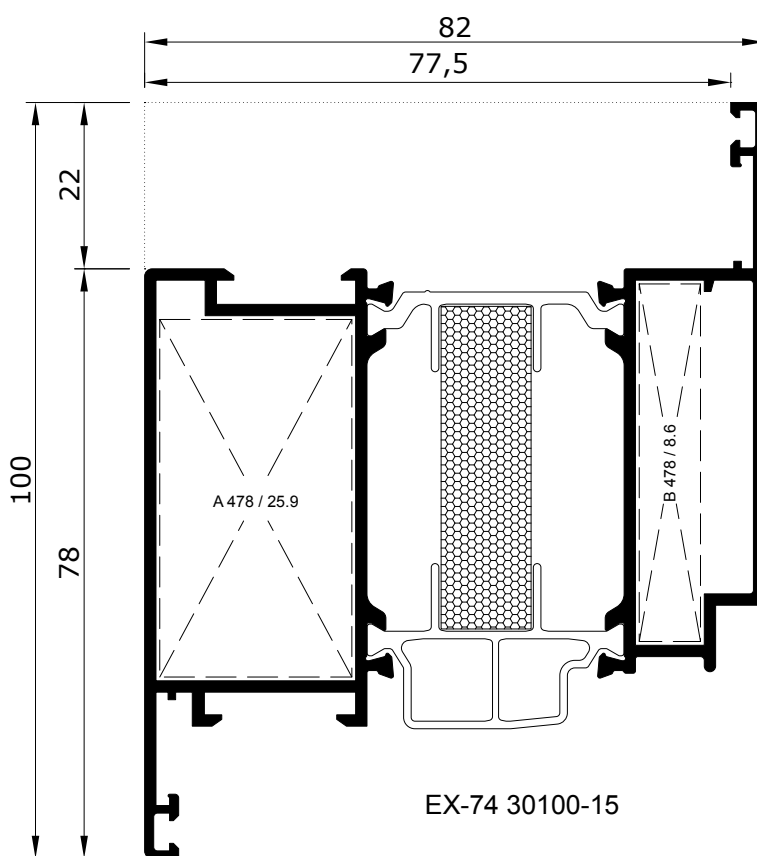

Profile No.	Weight (kg/m)	Static Value
کد پروفیل	وزن پروفیل	Jx (cm <sup>4</sup> ) Jy (cm <sup>4</sup> )
EX-74 34070-15	1.659 kg/m	
EX-74 34080-15	1.854 kg/m	

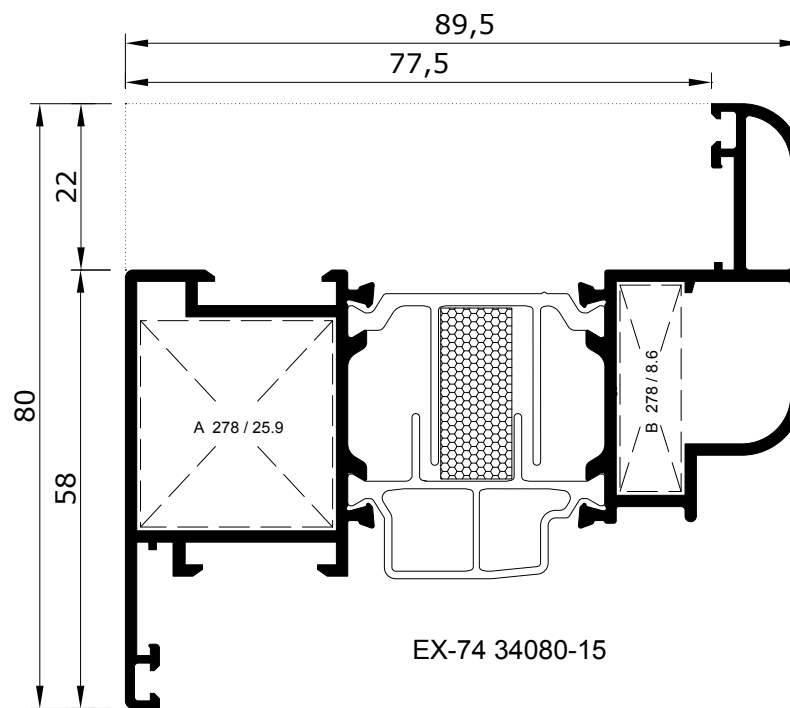
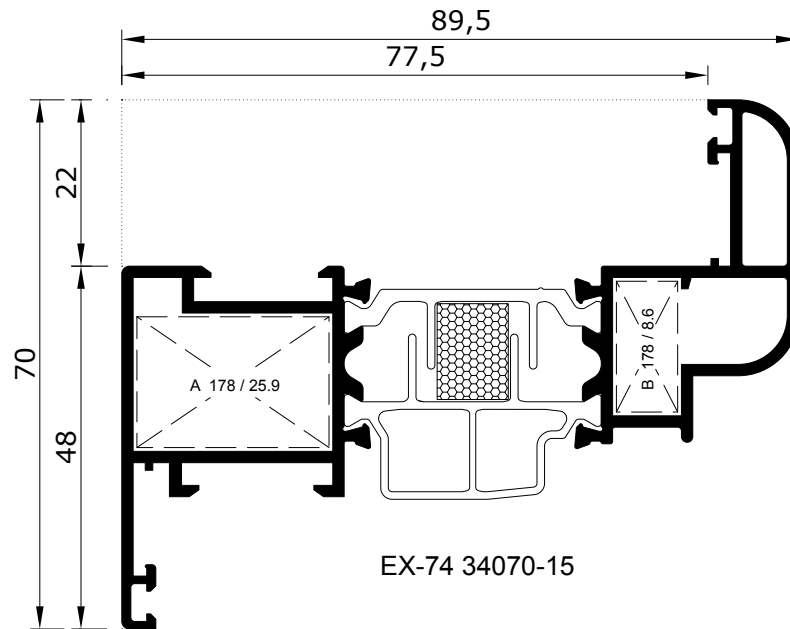

Profile No.	Weight (kg/m)	Static Value
کد پروفیل	وزن پروفیل	Jx (cm <sup>4</sup> ) Jy (cm <sup>4</sup> )
EX-74 34100-15	2.147 kg/m	

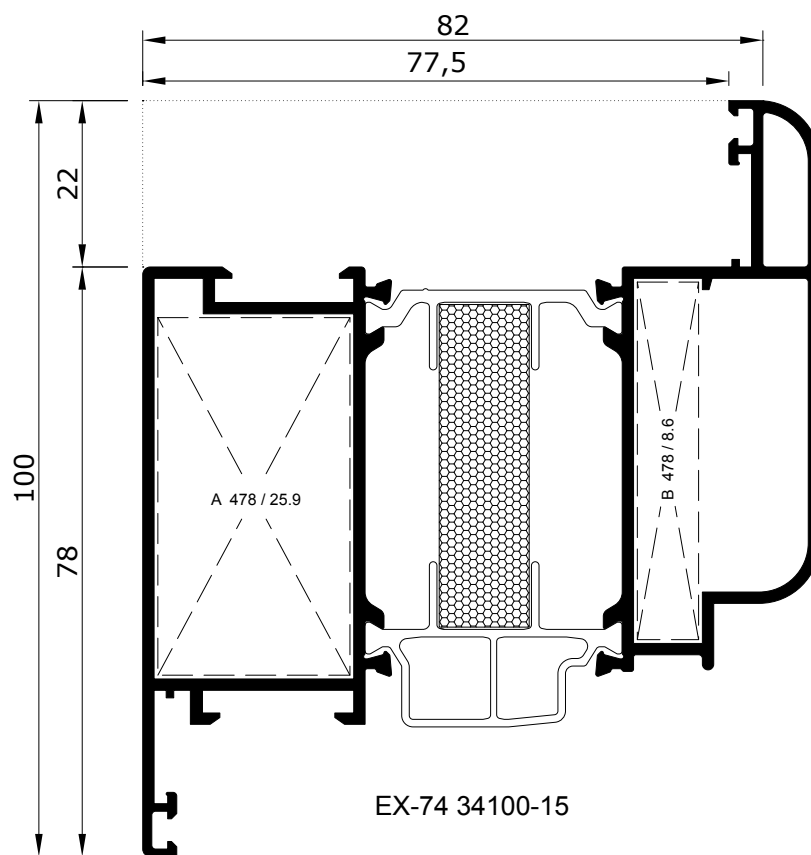

Profile No. کد پروفیل	Weight (kg/m) وزن پروفیل	Static Value Jx (cm <sup>4</sup> ) Jy (cm <sup>4</sup> )
EX-74 39100-15	2.088 kg/m	
EX-74 Panel	0.625 kg/m	
EX-74 49050-15	1.348 kg/m	
EX-74 40061-15	1.412 kg/m	

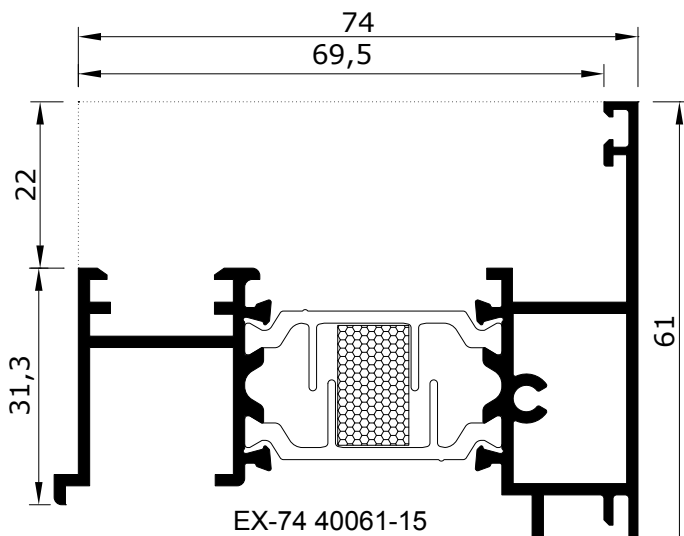
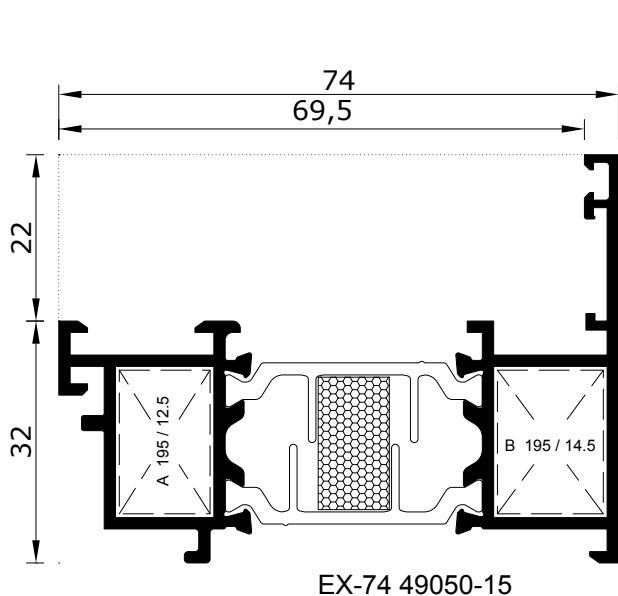
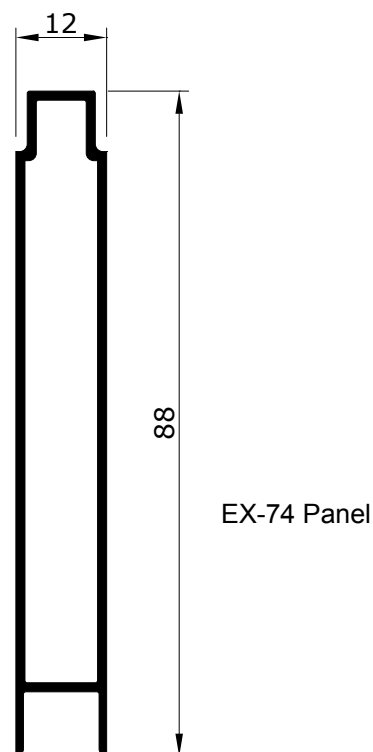
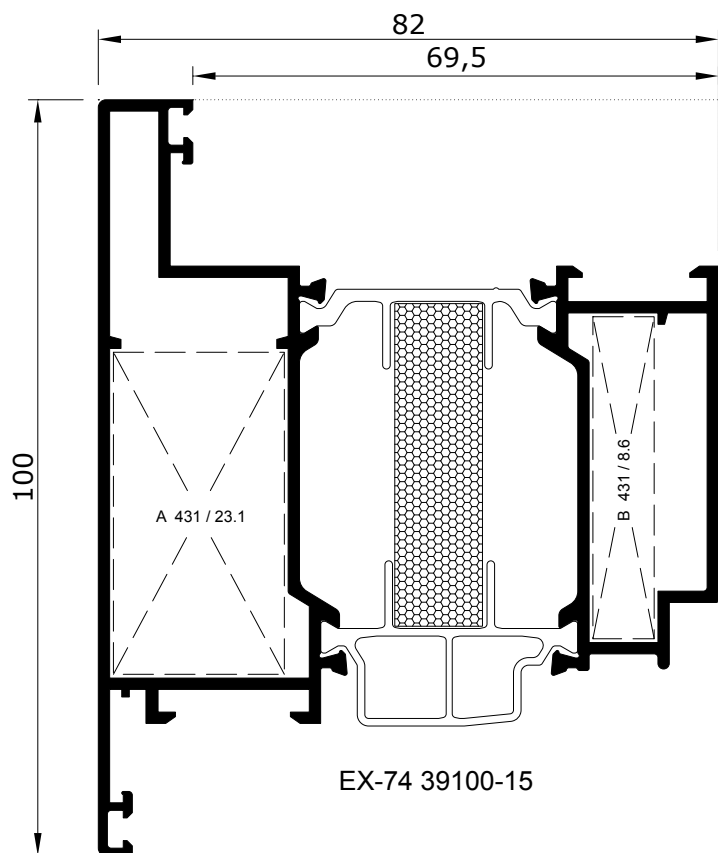

Profile No.	Weight (kg/m)	Static Value Jx (cm <sup>4</sup> ) Jy (cm <sup>4</sup> )
کد پروفیل	وزن پروفیل	
EX-74 40100-15	1.393 kg/m	
EX-74 40100-15-C	1.156 kg/m	
EX-74 40075-15	1.551 kg/m	
EX-74 40076-15	0.171 kg/m	
EX-74 40077-15	0.113 kg/m	
EX 45055-15	0.383 kg/m	

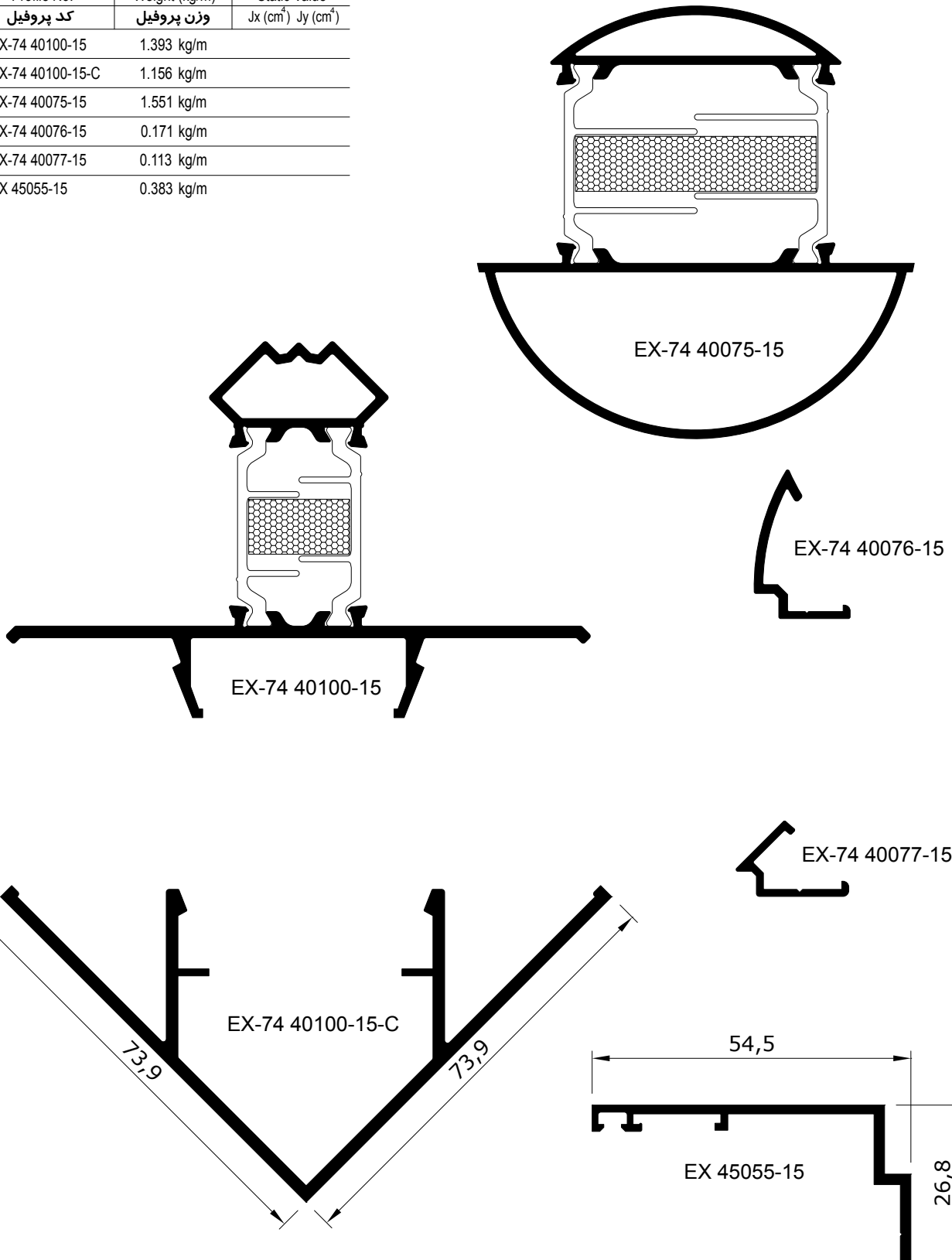

Profile No.	Weight (kg/m)	Static Value
کد پروفیل	وزن پروفیل	Jx (cm <sup>4</sup> ) Jy (cm <sup>4</sup> )
EX-74 12088-15	1.497 kg/m	49.11 / 16.36
EX-74 22110-15	1.600 kg/m	49.22 / 23.95
EX-74 32070-15	1.393 kg/m	
EX 42040-15	0.526 kg/m	

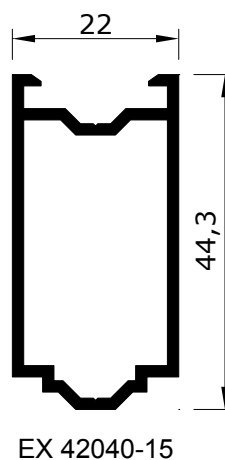
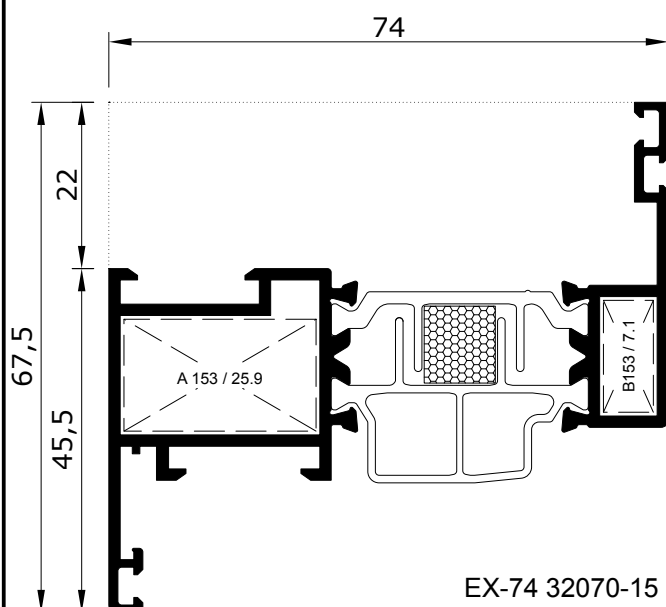
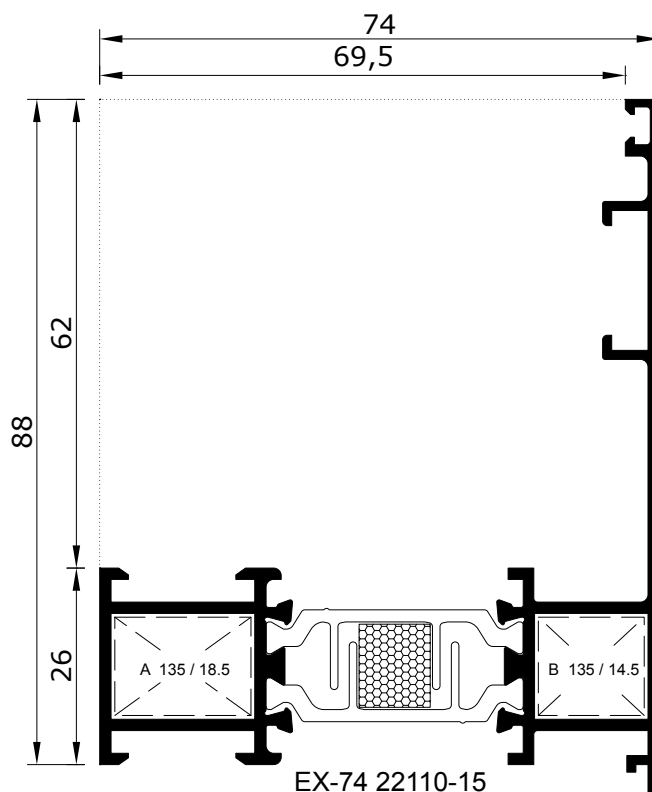
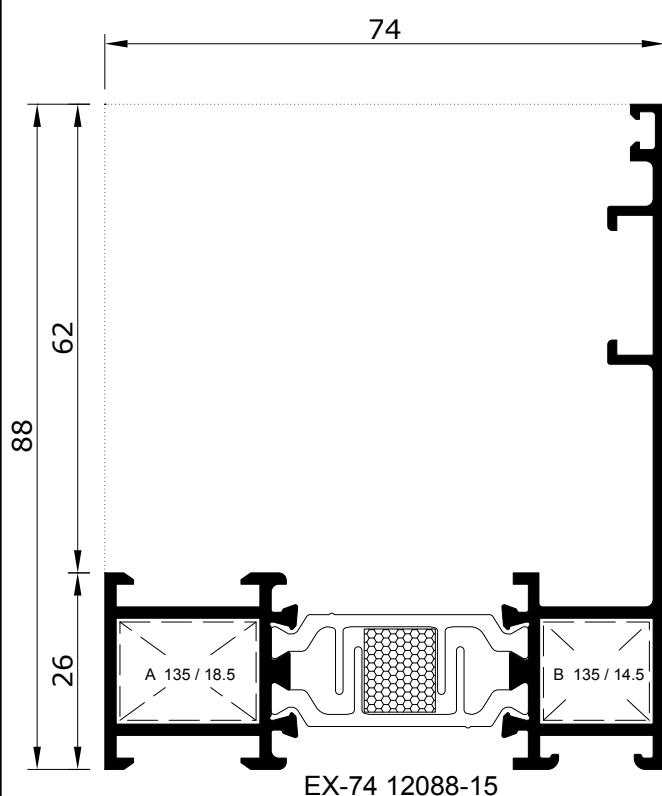



Profile No.	Weight (kg/m)	Static Value
کد پروفیل	وزن پروفیل	Jx (cm <sup>4</sup> ) Jy (cm <sup>4</sup> )
EX-74 22150-15	1.803 kg/m	45.27 / 63.20
EX-74 42150-15	1.852 kg/m	

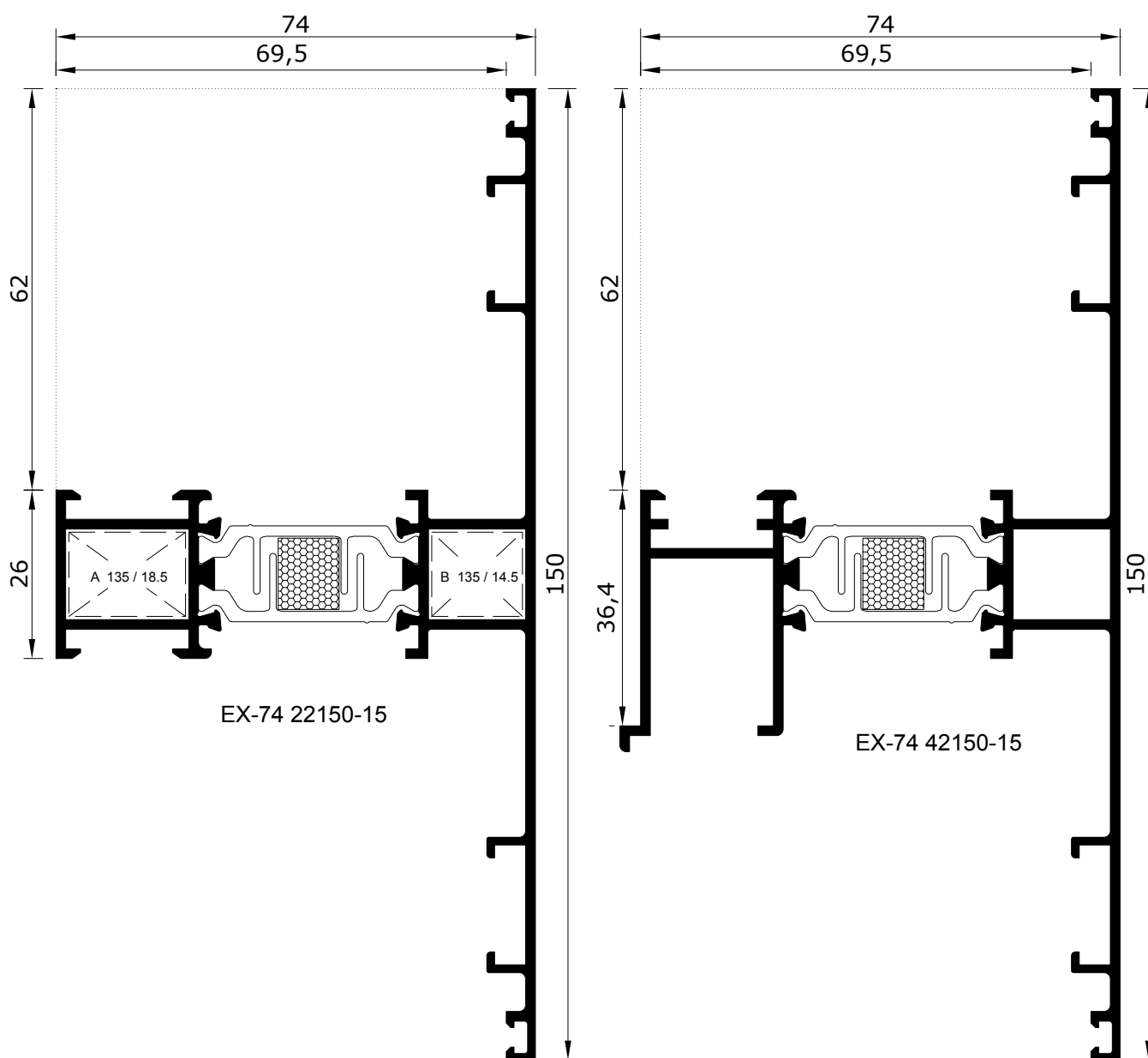

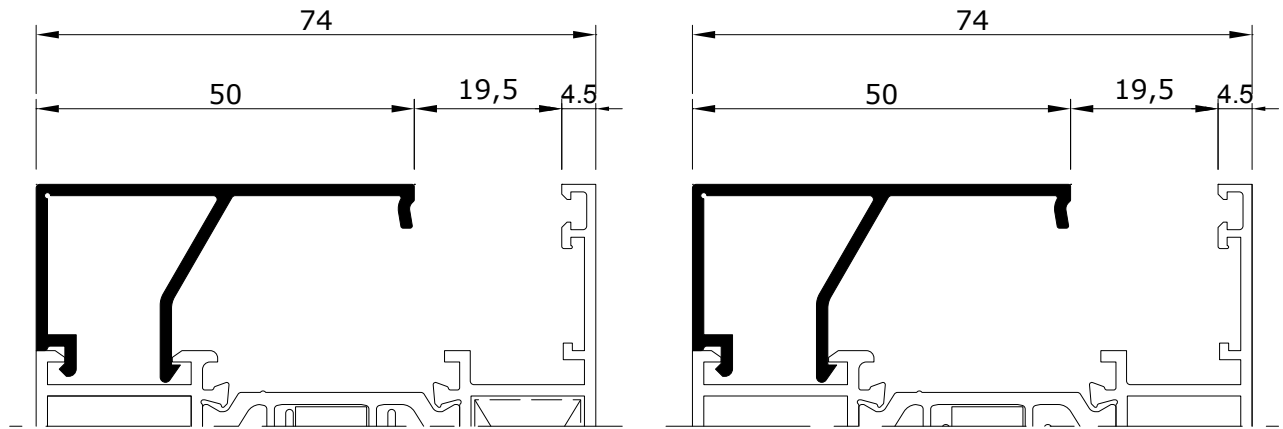

EX 50050-15  
0.448 kg/m

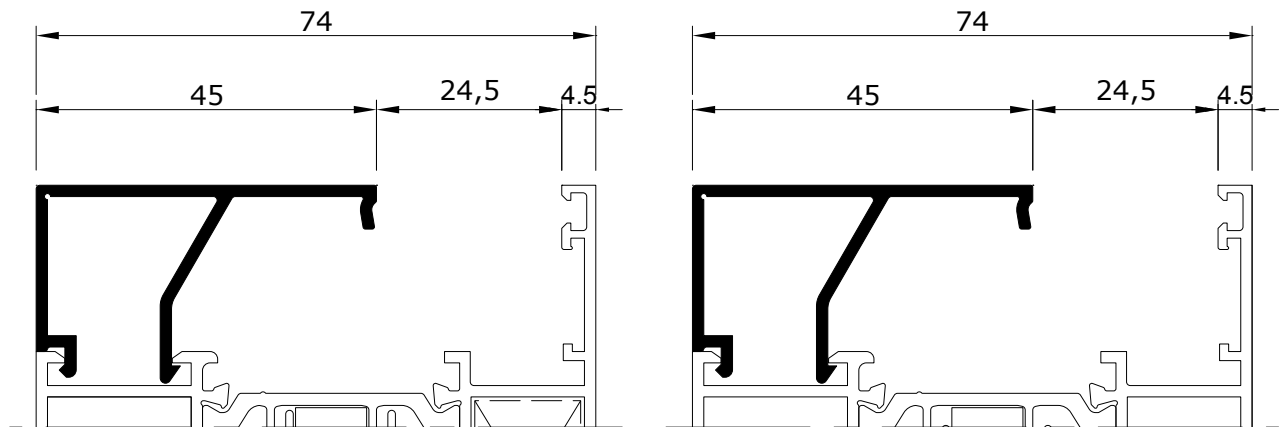

EX 50045-15  
0.409 kg/m

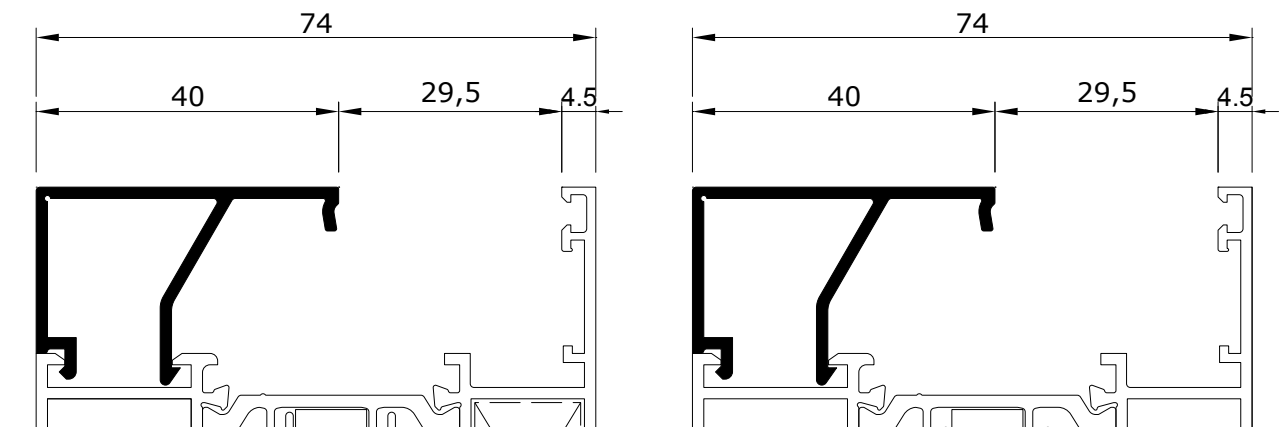

EX 50040-15  
0.407 kg/m

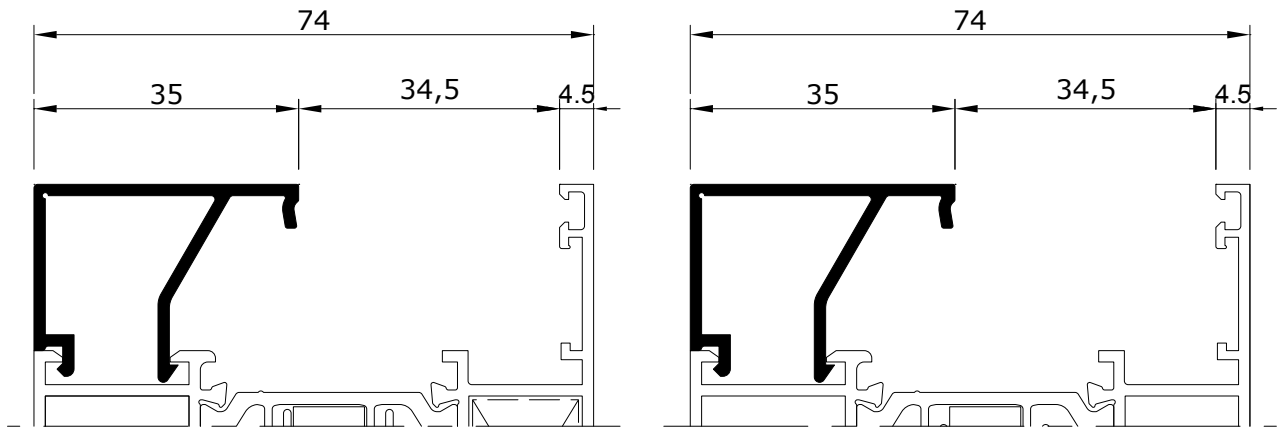

EX 50035-15  
0.387 kg/m

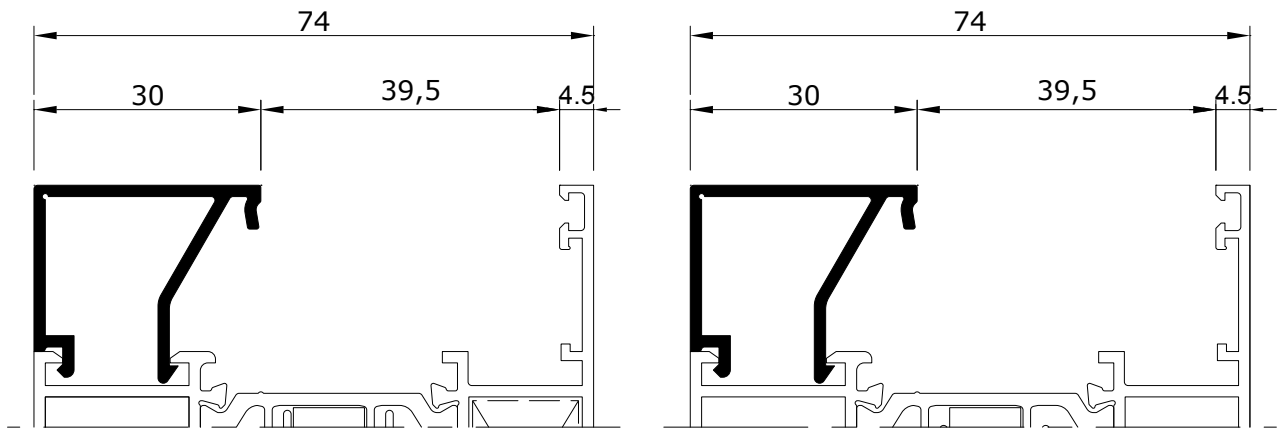

EX 50030-15  
0.367 kg/m

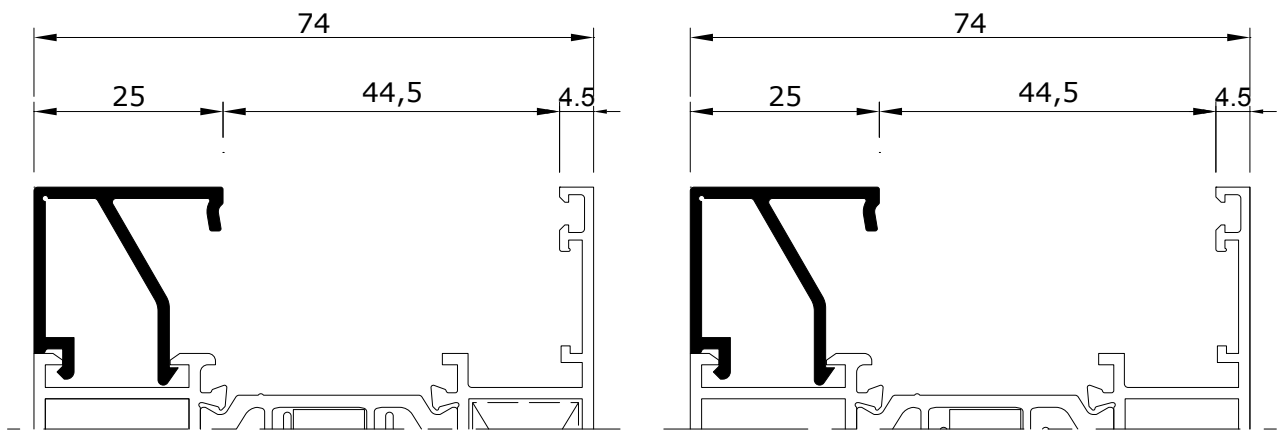

EX 50025-15  
0.346 kg/m

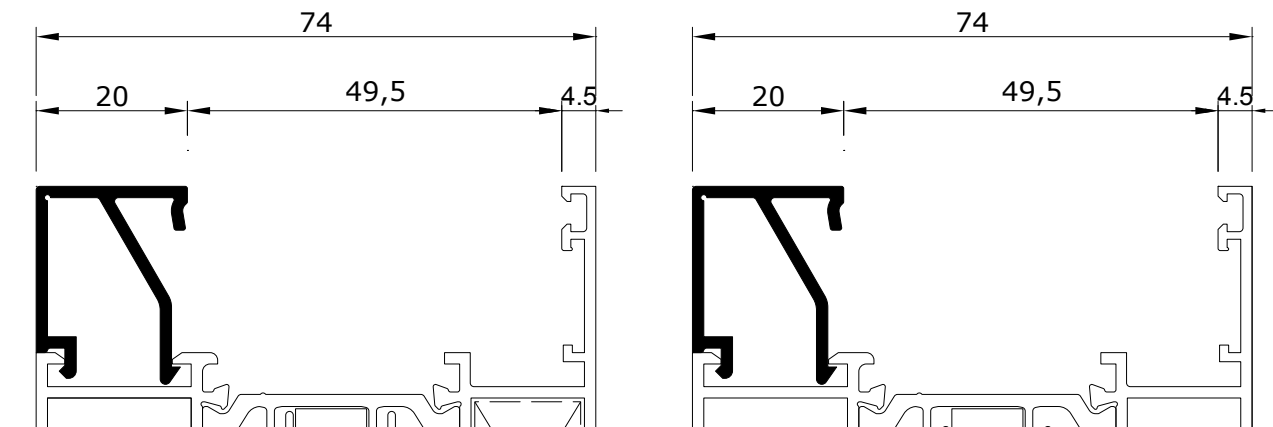

EX 50020-15  
0.326 kg/m

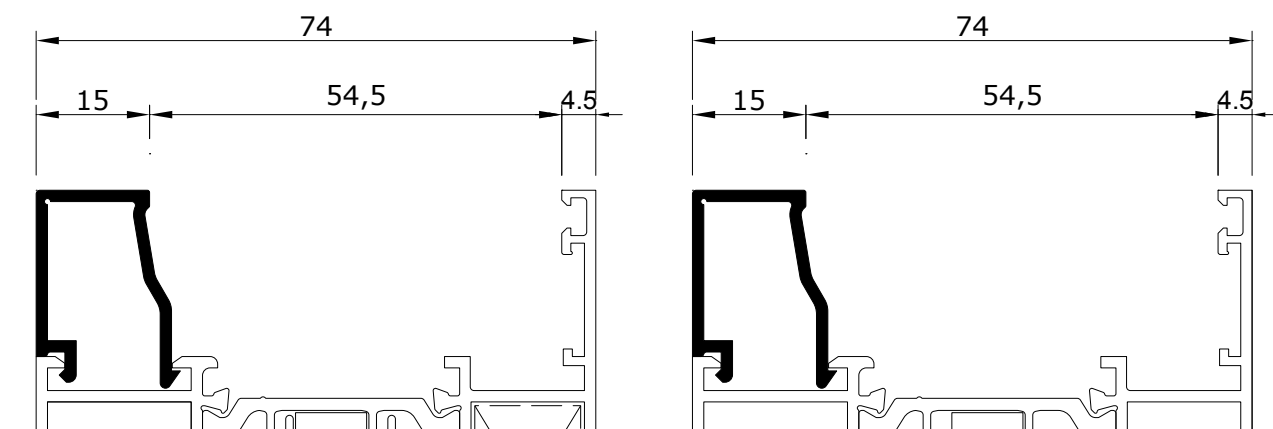

EX 50015-15  
0.282 kg/m

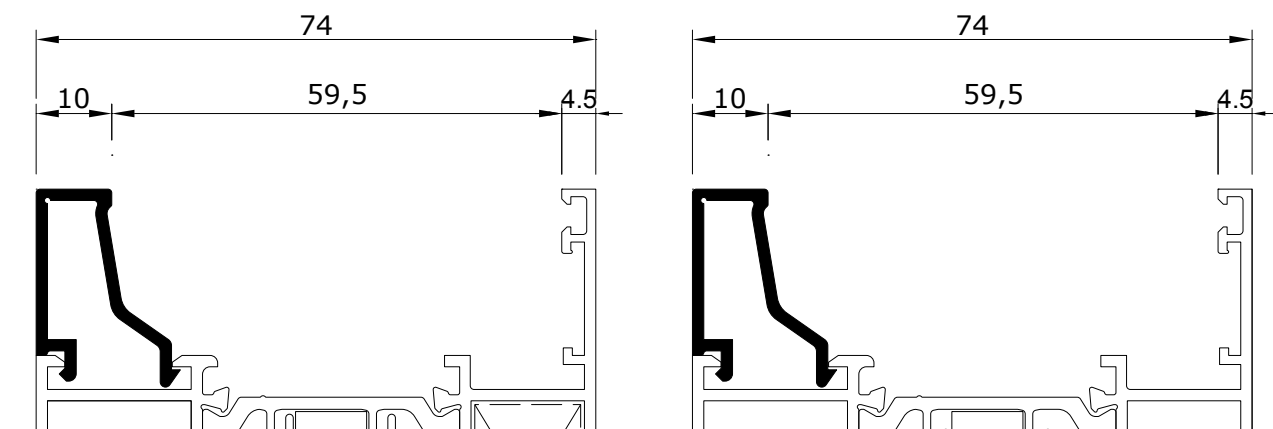

EX 50010-15  
0.273 kg/m

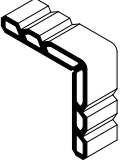
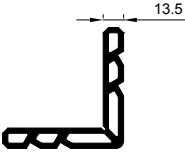
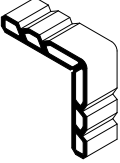
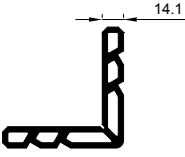
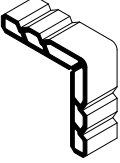
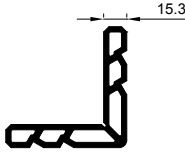
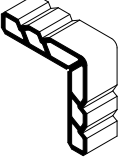
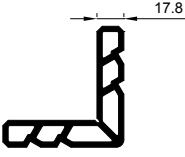
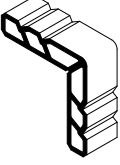
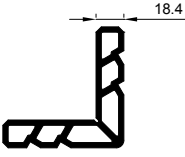
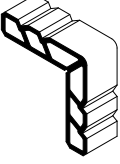
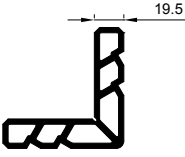
<b>3D Picture</b> تصوير سه بعدی	<b>2D Picture</b> تصوير محصول	<b>Features</b> مشخصات فنی	<b>Used Profiles</b> پروفیل مصرفی
		PC-135  3.256 Kg/m	EX-74 10048-15 EX-74 14048-15 EX-74 20070-15 EX-74 22110-15 EX-74 12088-15 EX-74 22150-15
		PC-141  3.307 Kg/m	EX-74 10048-12  EX-74 14048-12  EX-74 20070-12
		PC-153  3.344 Kg/m	EX-74 32070-15
		PC-178  3.507 Kg/m	EX-74 30070-15 EX-74 30080-15 EX-74 34070-15
		PC-184  3.546 Kg/m	EX-74 30070-12  EX-74 34070-12
		PC-195  3.618 Kg/m	EX-74 49050-15

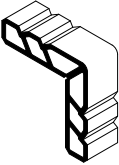
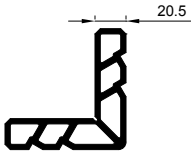
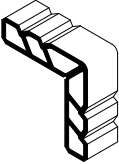
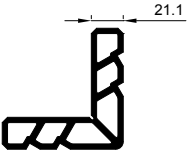
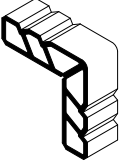
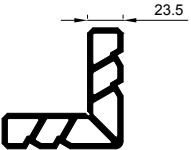
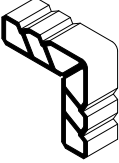
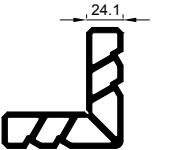
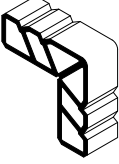
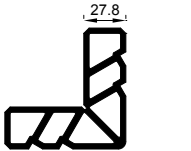
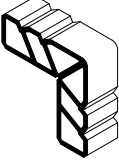
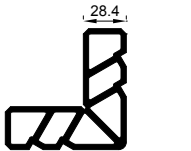

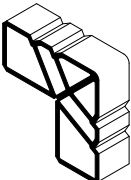
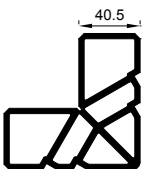
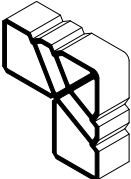
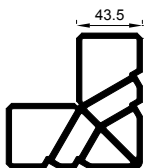
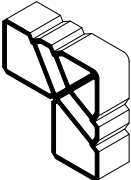
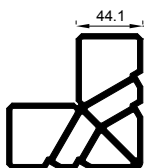
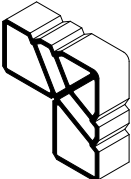
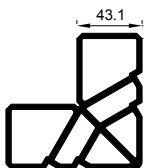
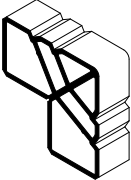
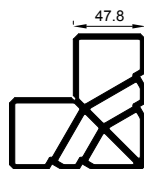
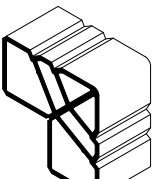
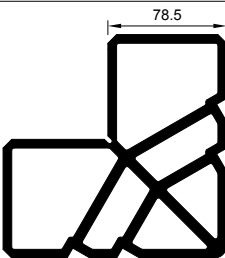

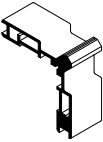
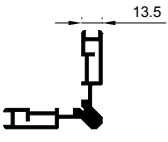
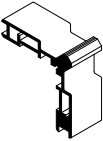
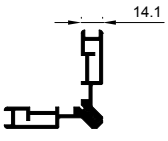
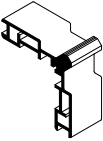
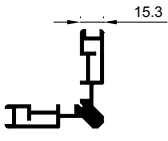
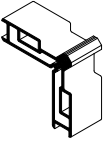
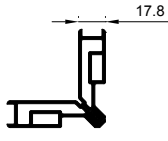
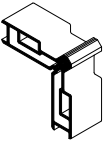
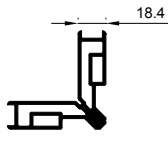
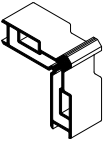
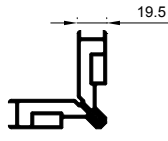

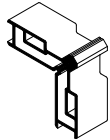
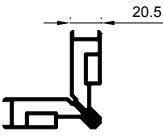
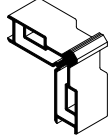
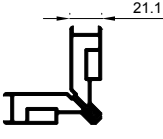
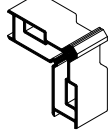
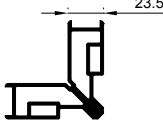
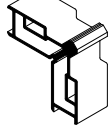
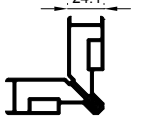
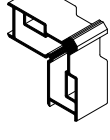
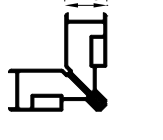
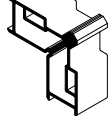
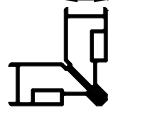

<b>3D Picture</b> تصویر سه بعدی	<b>2D Picture</b> تصویر محصول	<b>Features</b> مشخصات فنی	<b>Used Profiles</b> پروفیل مصرفی
		PC-205  3.684 Kg/m	EX-74 35080-15  EX-74 35480-15
		PC-211  3.723 Kg/m	EX-74 35080-12  EX-74 35480-12
		PC-235  3.880 Kg/m	EX-74 10058-15 EX-74 14058-15 EX-74 15058-15 EX-74 20080-15
		PC-241  3.919 Kg/m	EX-64 30070-12  EX-74 14058-12  EX-74 20080-12
		PC-278  4.162 Kg/m	EX-74 30080-15 EX-74 34080-15 EX-74 35480-15 EX-74 35080-15
		PC-284  4.202 Kg/m	EX-74 30080-12 EX-74 34080-12 EX-74 35480-12 EX-74 35080-12

<b>3D Picture</b> تصوير سه بعدی	<b>2D Picture</b> تصوير محصول	<b>Features</b> مشخصات فنی	<b>Used Profiles</b> پروفیل مصرفی
		PC-405  5.101 Kg/m	EX-74 35100-15  EX-74 35499-15
		PC-435  5.196 Kg/m	EX-74 10078-15  EX-74 14078-15  EX-74 20100-15
		PC-441  5.217 Kg/m	EX-74 10078-12  EX-74 14078-12  EX-74 20100-12
		PC-431  5.191Kg/m	EX-74 39100-15
		PC-478  5.260 Kg/m	EX-74 30100-15  EX-74 34100-15  EX-74 35499-15  EX-74 35100-15
		PC-785  0000 Kg/m	EX-74 60135-15

<b>3D Picture</b> تصویر سه بعدی	<b>2D Picture</b> تصویر محصول	<b>Features</b> مشخصات فنی	<b>Used Profiles</b> پروفیل مصرفی
		<b>GC-135</b>  1.712 Kg/m	EX-74 10048-15 EX-74 14048-15 EX-74 20070-15 EX-74 22110-15 EX-74 12088-15 EX-74 22150-15
		<b>GC-141</b>  1.748 Kg/m	EX-74 10048-12  EX-74 14048-12  EX-74 20070-12
		<b>GC-153</b>  1.830 Kg/m	EX-74 32070-15
		<b>GC-178</b>  2.044 Kg/m	EX-74 30070-15 EX-74 30080-15 EX-74 34070-15
		<b>GC-184</b>  2.053 Kg/m	EX-74 30070-12  EX-74 34070-12
		<b>GC-195</b>  2.069 Kg/m	EX-74 49050-15

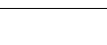

<b>3D Picture</b> تصوير سه بعدی	<b>2D Picture</b> تصوير محصول	<b>Features</b> مشخصات فنی	<b>Used Profiles</b> پروفیل مصرفی
		<b>GC-205</b>  2.084 Kg/m	EX-74 10048-15 EX-74 14048-15 EX-74 20070-15 EX-74 22110-15 EX-74 12088-15 EX-74 22150-15
		<b>GC-211</b>  2.093 Kg/m	EX-74 10048-12  EX-74 14048-12  EX-74 20070-12
		<b>GC-235</b>  2.128 Kg/m	EX-74 32070-15
		<b>GC-241</b>  2.137 Kg/m	EX-74 30070-15 EX-74 30080-15 EX-74 34070-15
		<b>GC-278</b>  2.191 Kg/m	EX-74 30070-12  EX-74 34070-12
		<b>GC-284</b>  2.199 Kg/m	EX-74 49050-15

تصویر محصول Picture	کد محصول Piece No.	نوع متریال Material	مشخصات فنی Description
	GP-200	TPV/NBR	لاستیک ۲ میل داخلی Interior Glazing Gasket 2 mm
	GP-300		لاستیک ۳/۵ میل داخلی Interior Glazing Gasket 3.5 mm
	GP-400		لاستیک ۵ میل داخلی Interior Glazing Gasket 5 mm
	GP500		لاستیک ۶/۵ میل داخلی Interior Glazing Gasket 6.5 mm
	GP-100		لاستیک لنگه داخلی Interior Overlap Gasket
	GP-740		لاستیک کله غازی Central Gasket
	GP700		لاستیک پشت شیشه Exterior Glazing Gasket
	GH-100		لاستیک سیستم لنگه مخفی Exterior Glazing Gasket For Hidden Sash
	GP-150		لاستیک خارجی لنگه Exterior Overlap Gasket

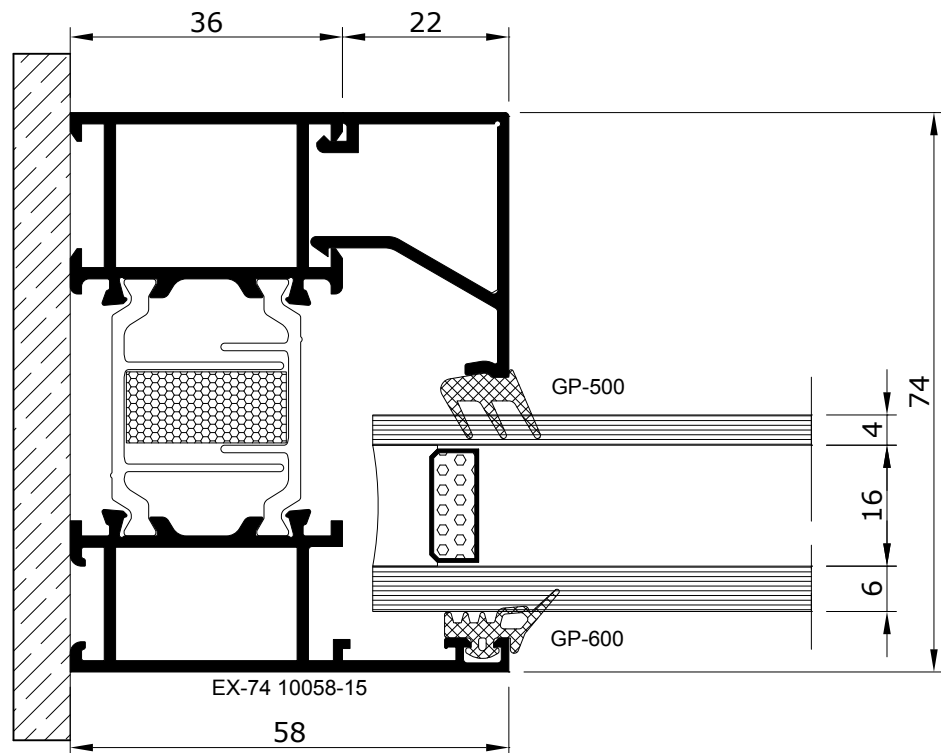
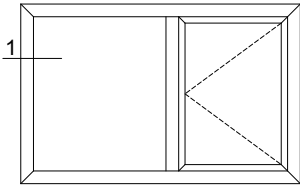

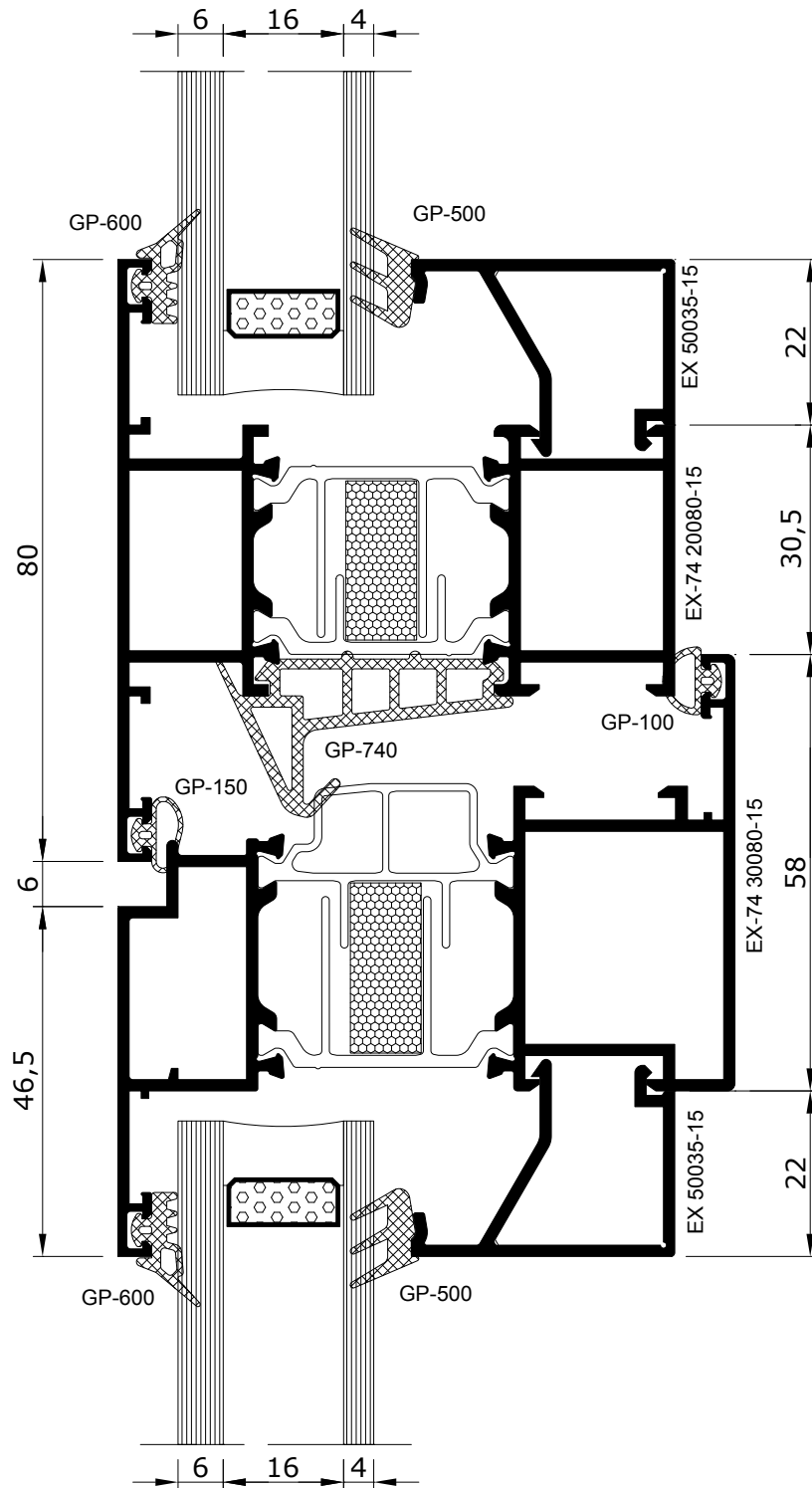
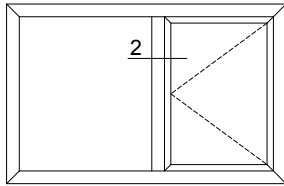

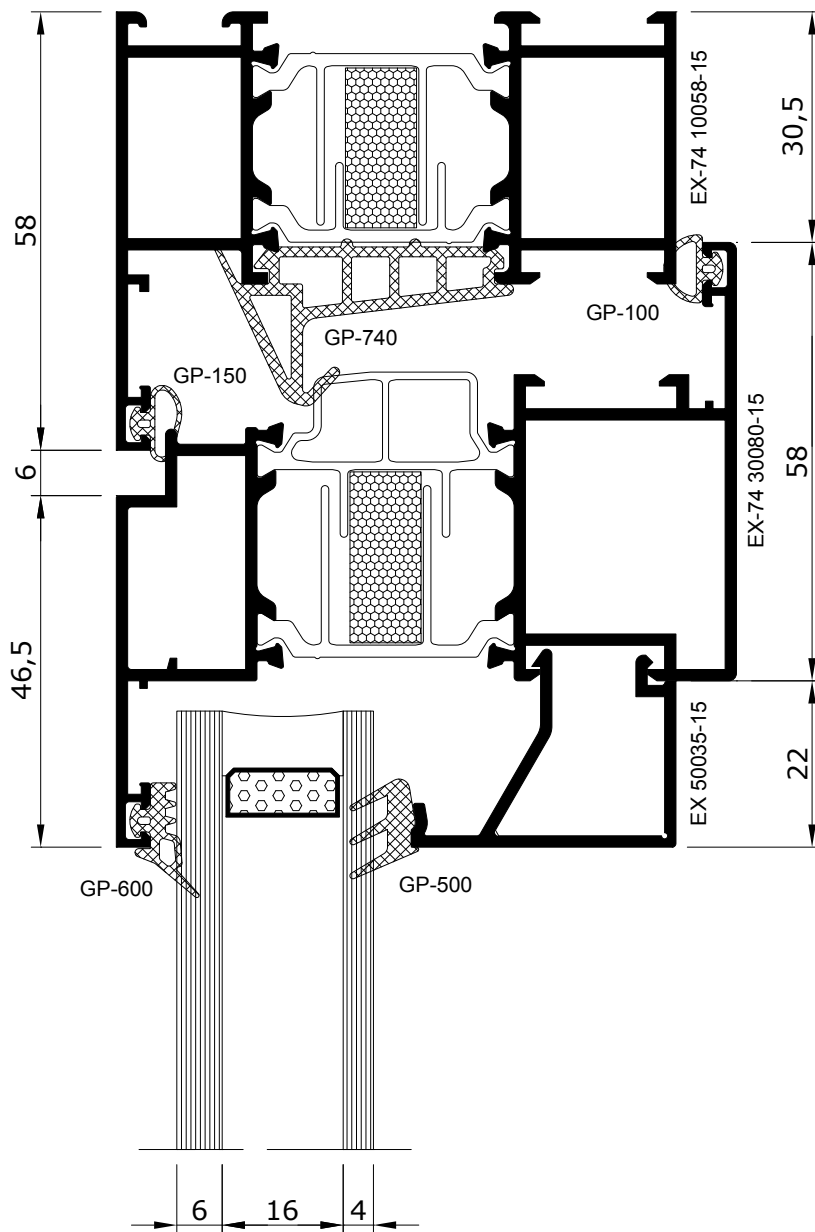
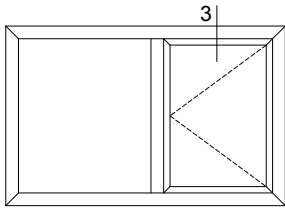

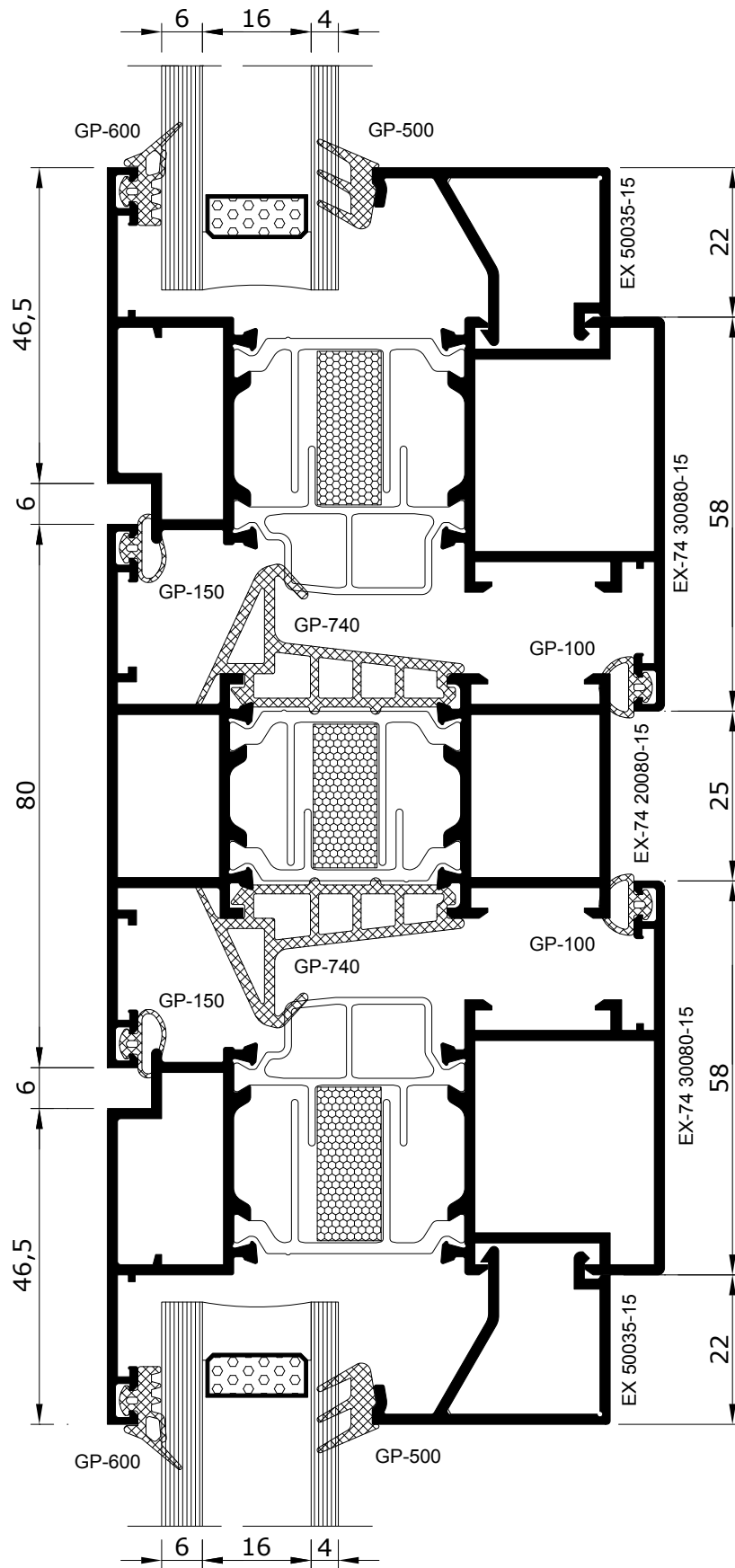
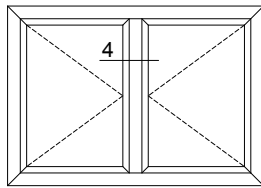

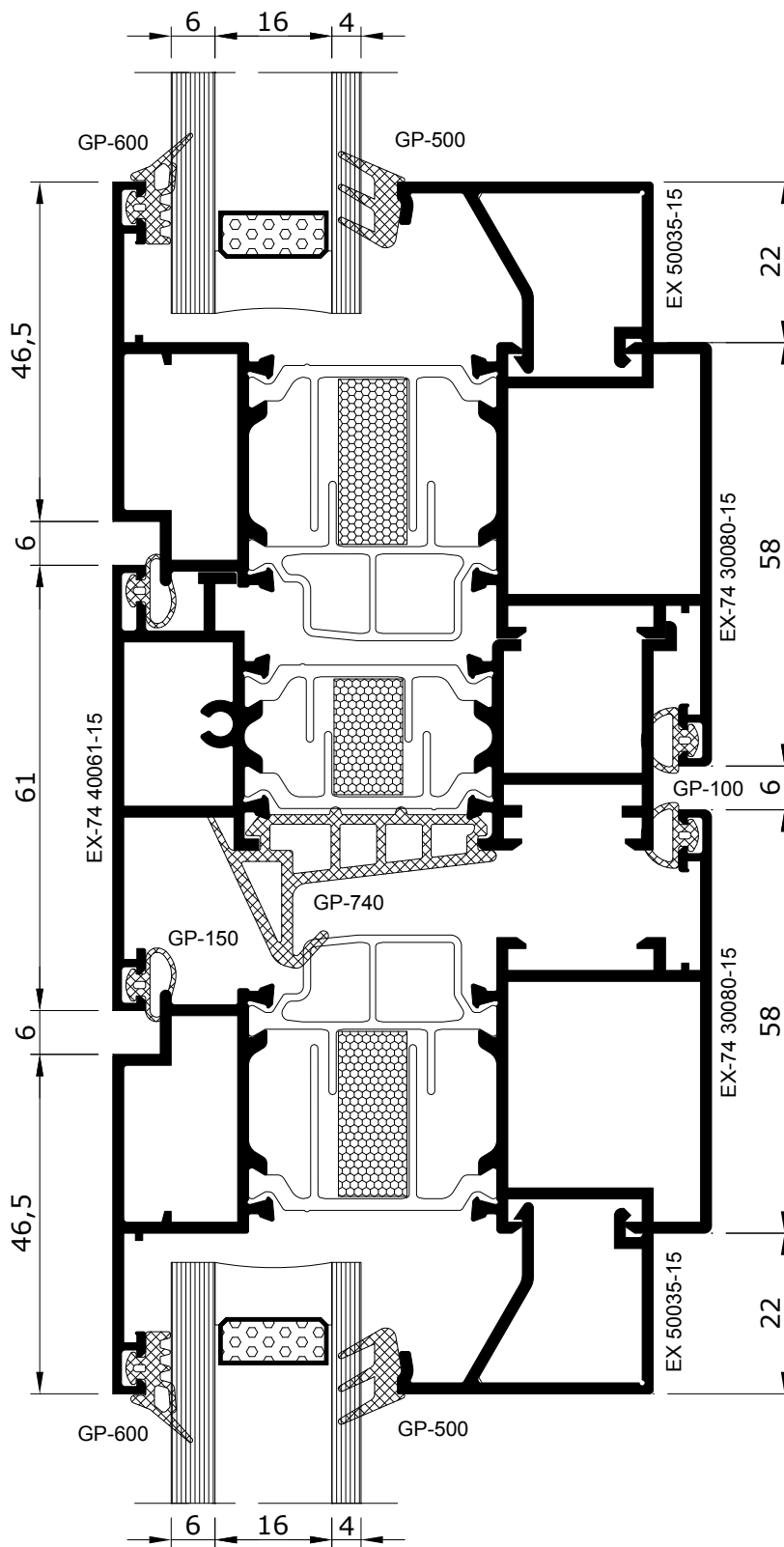
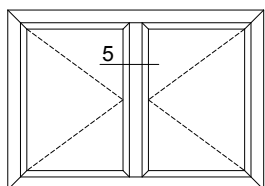

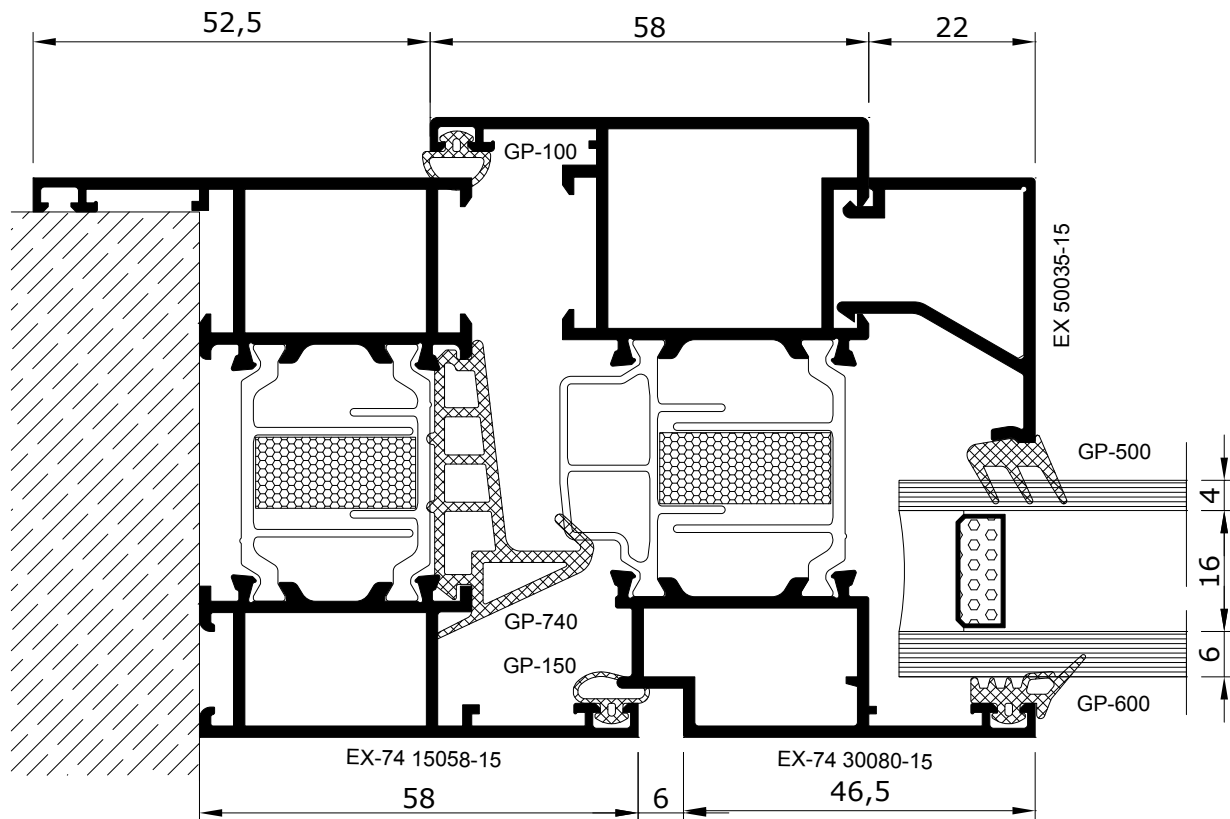
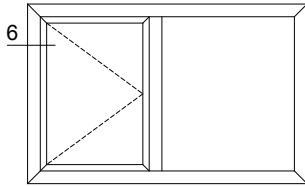



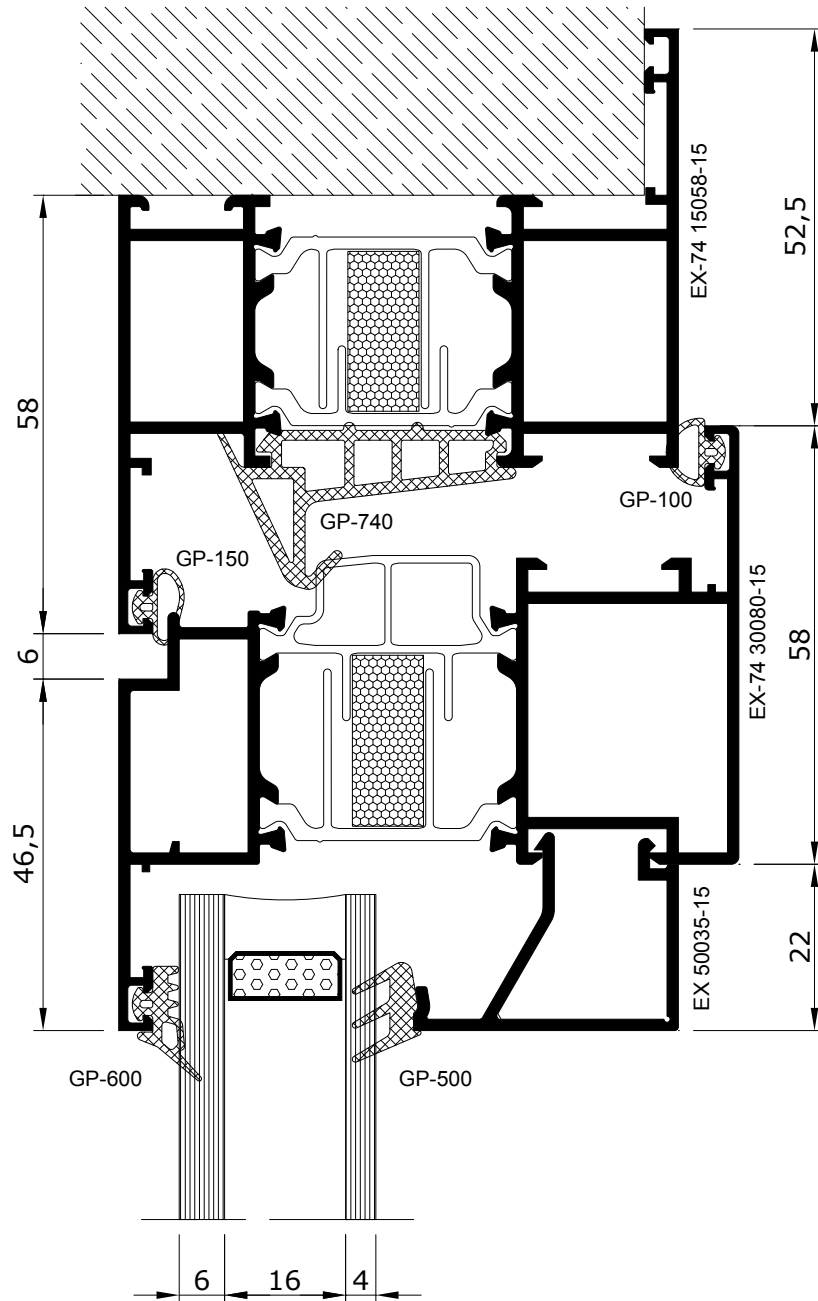
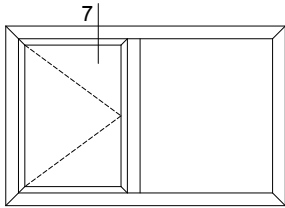

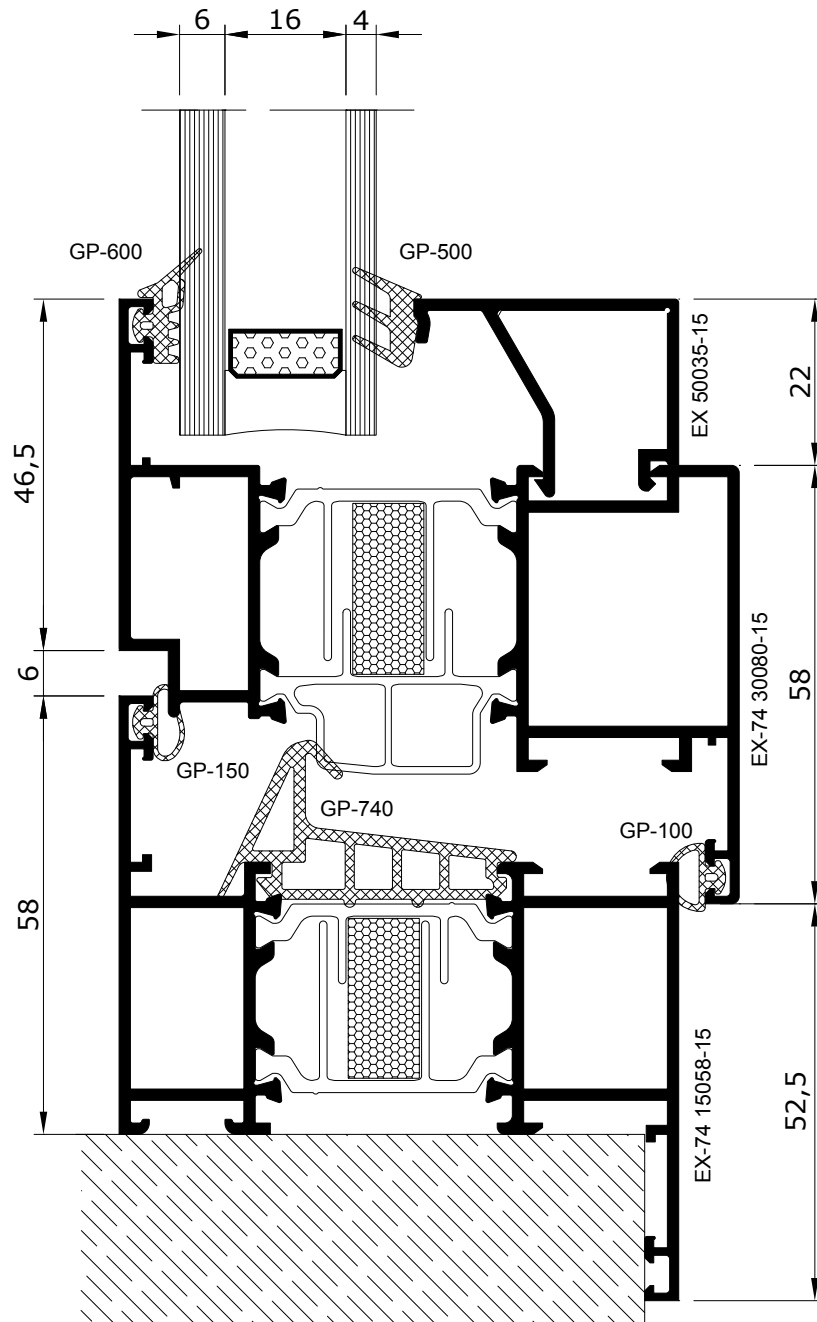
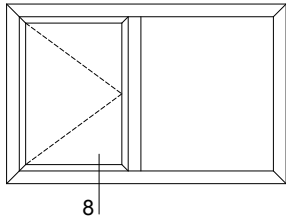

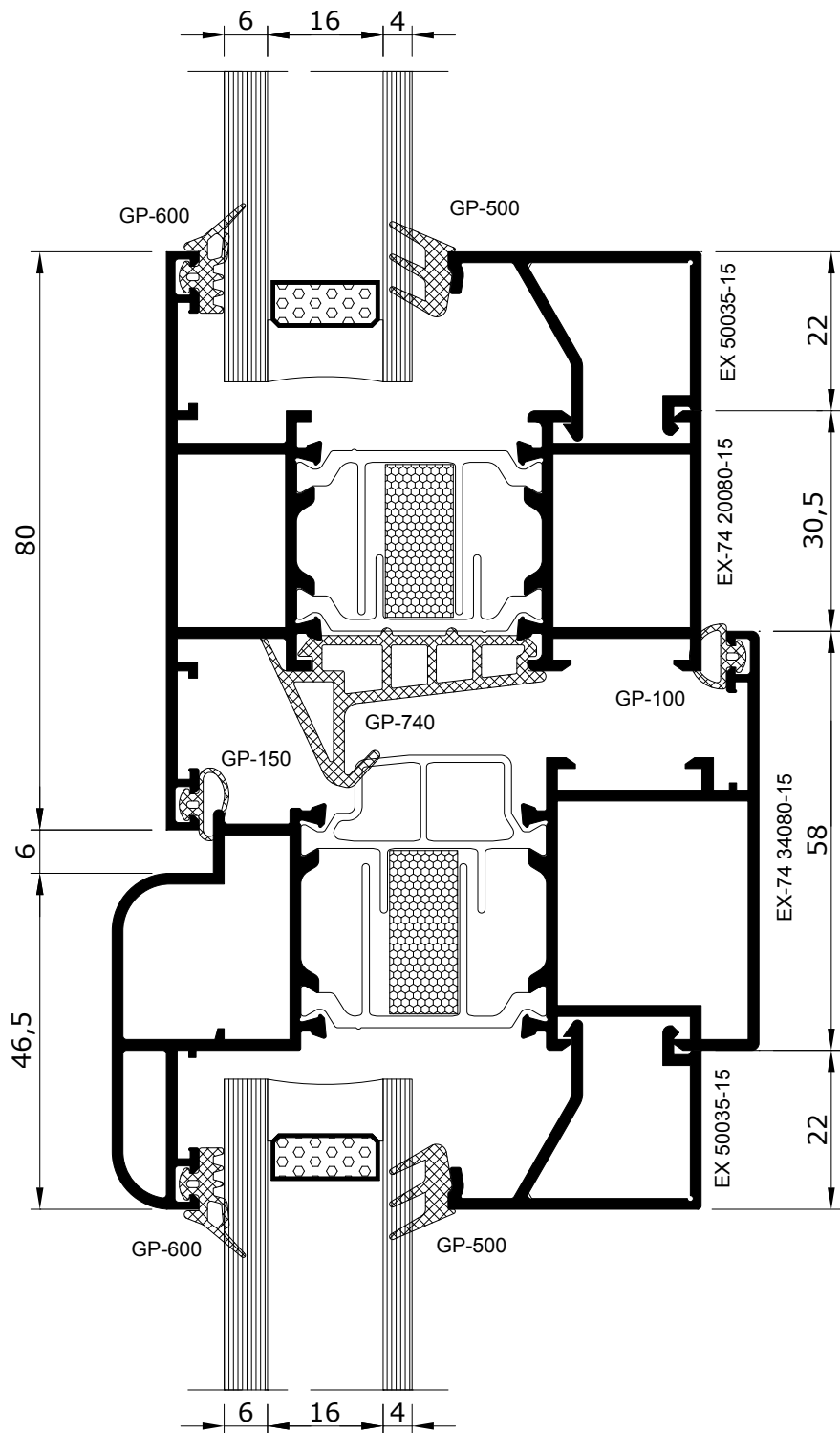
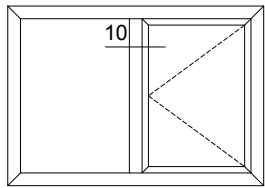

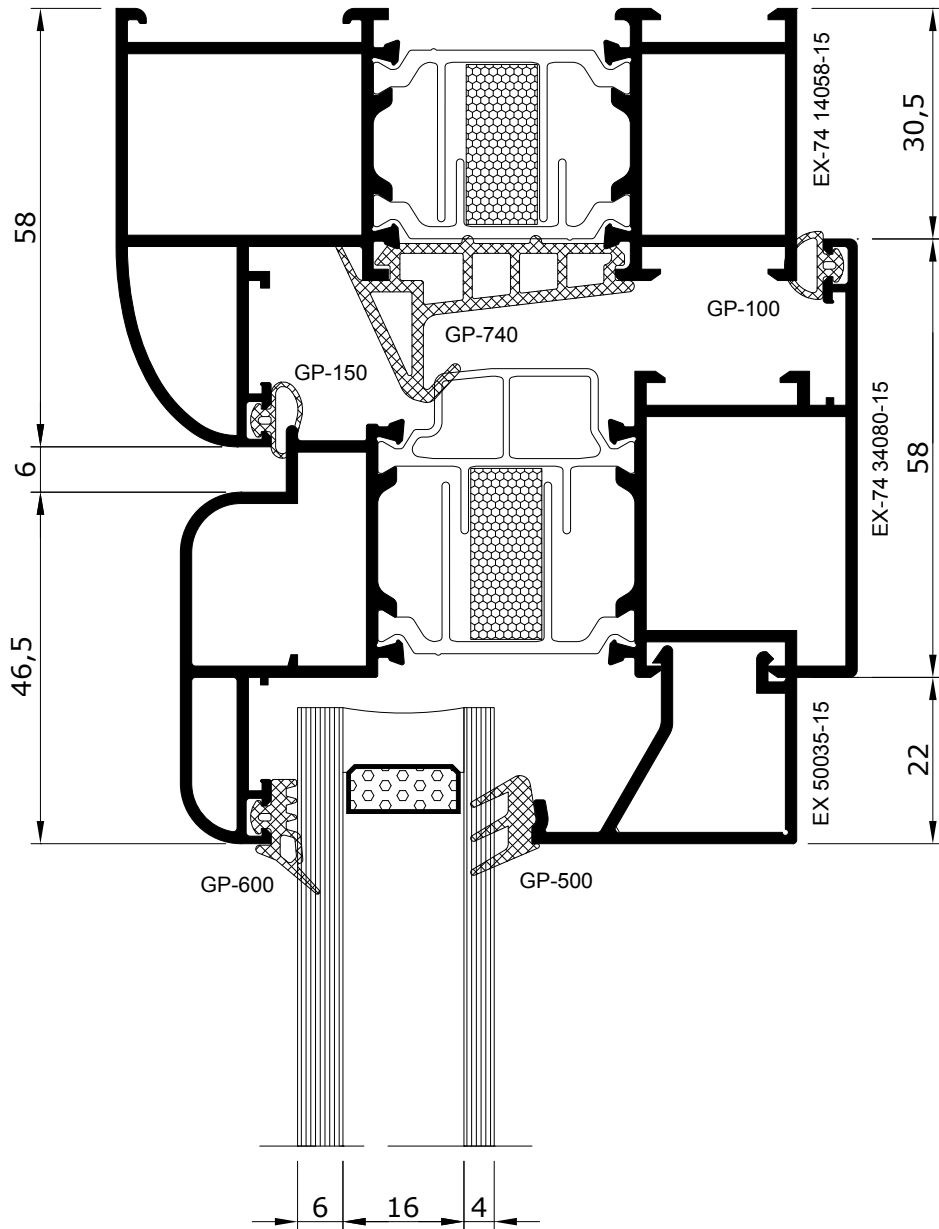
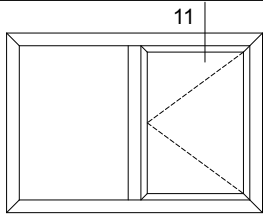

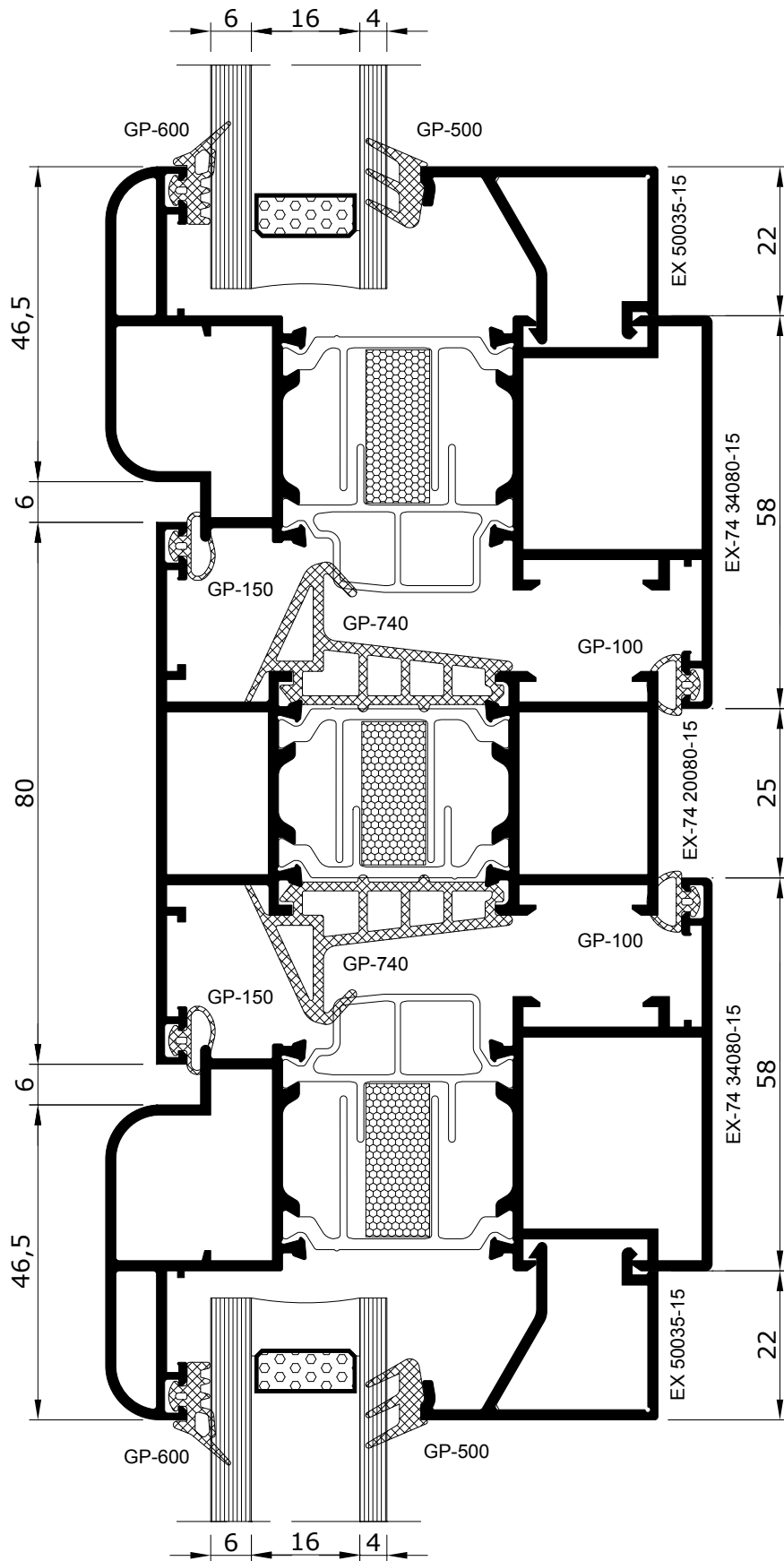
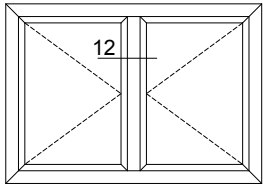

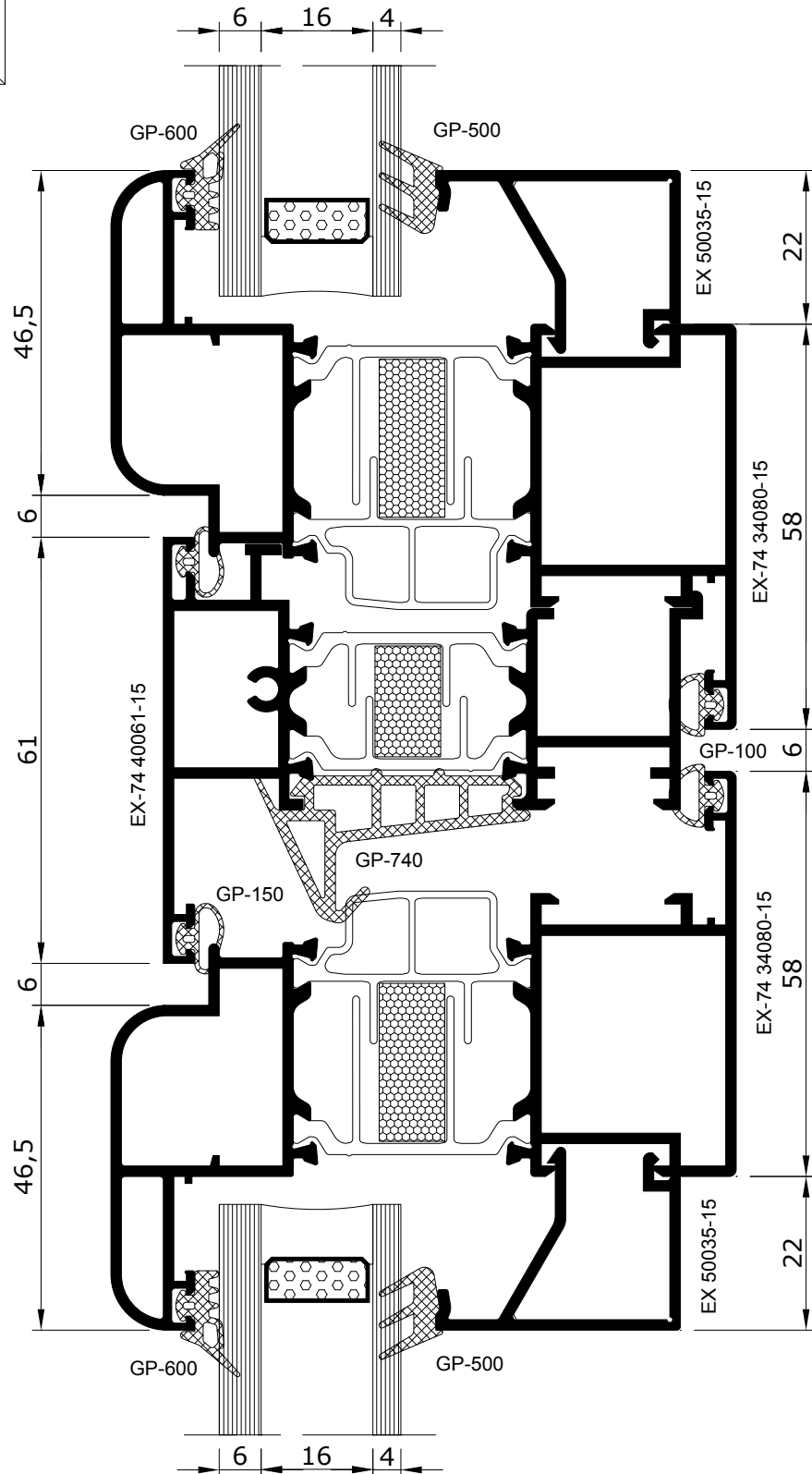
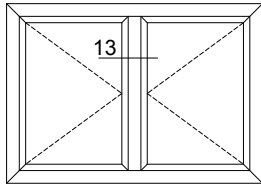

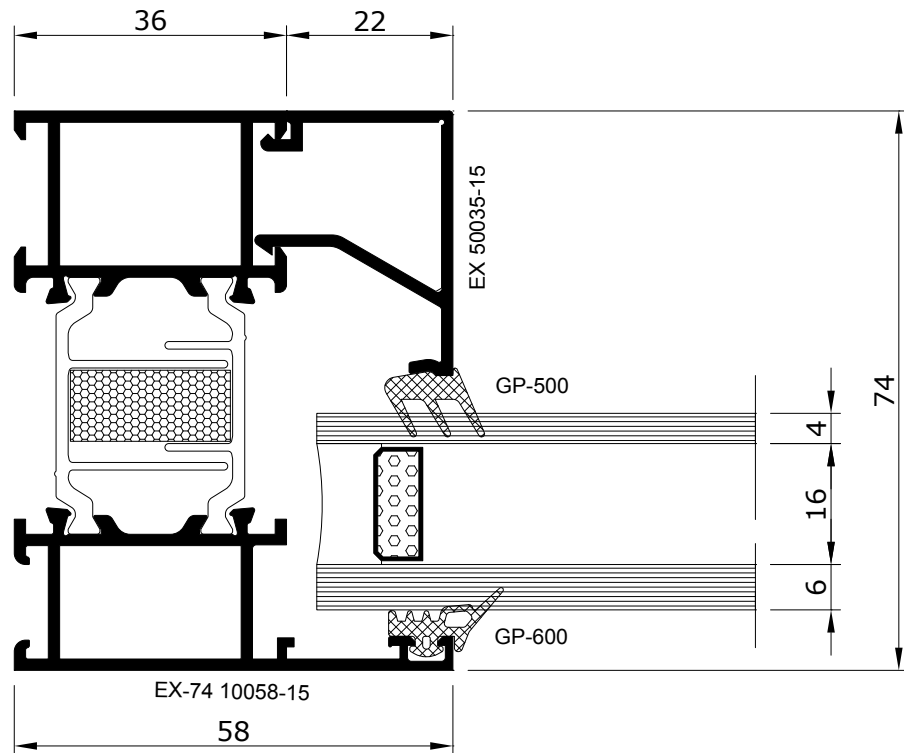
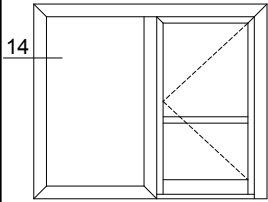

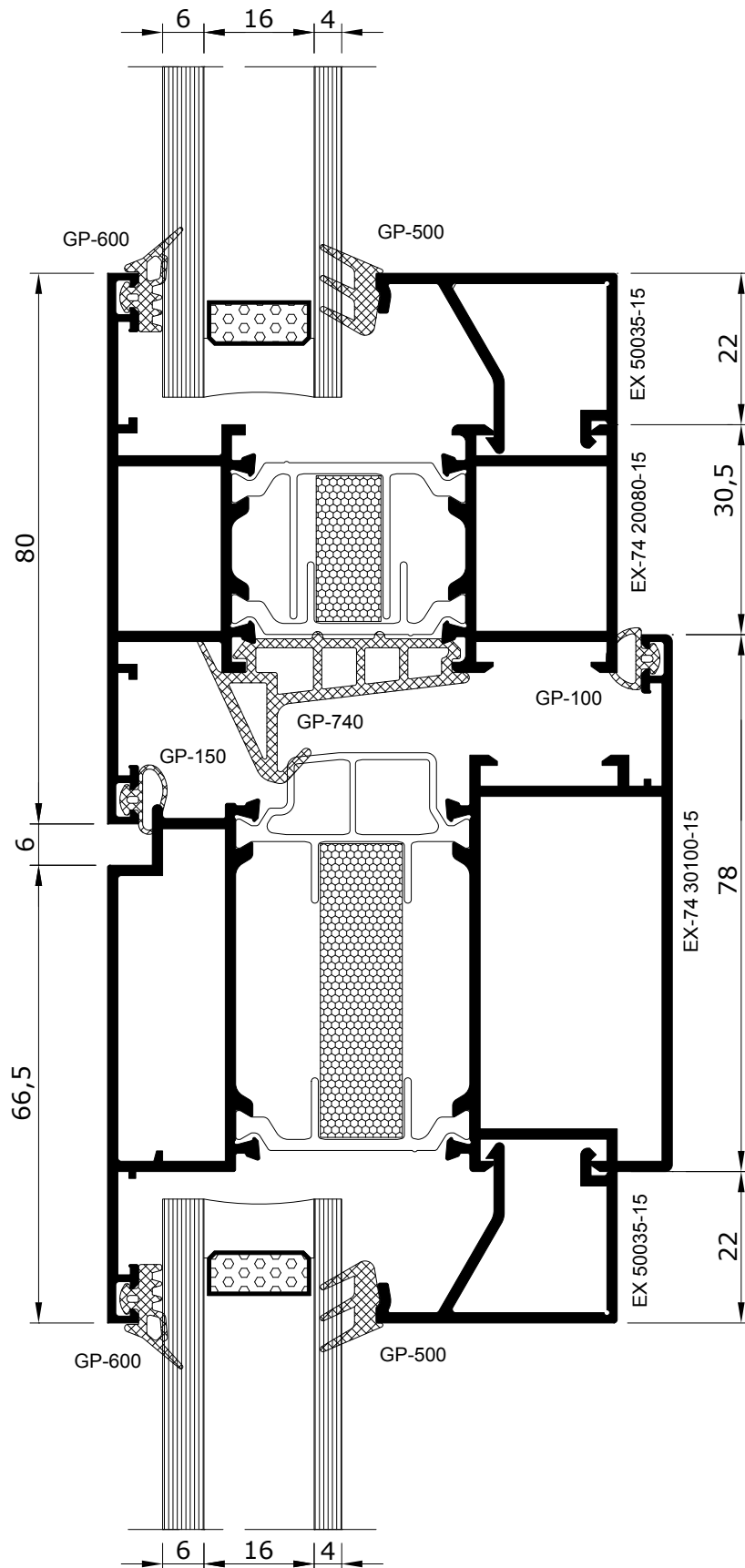
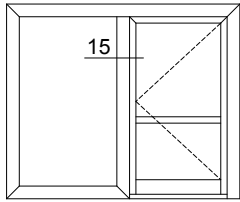



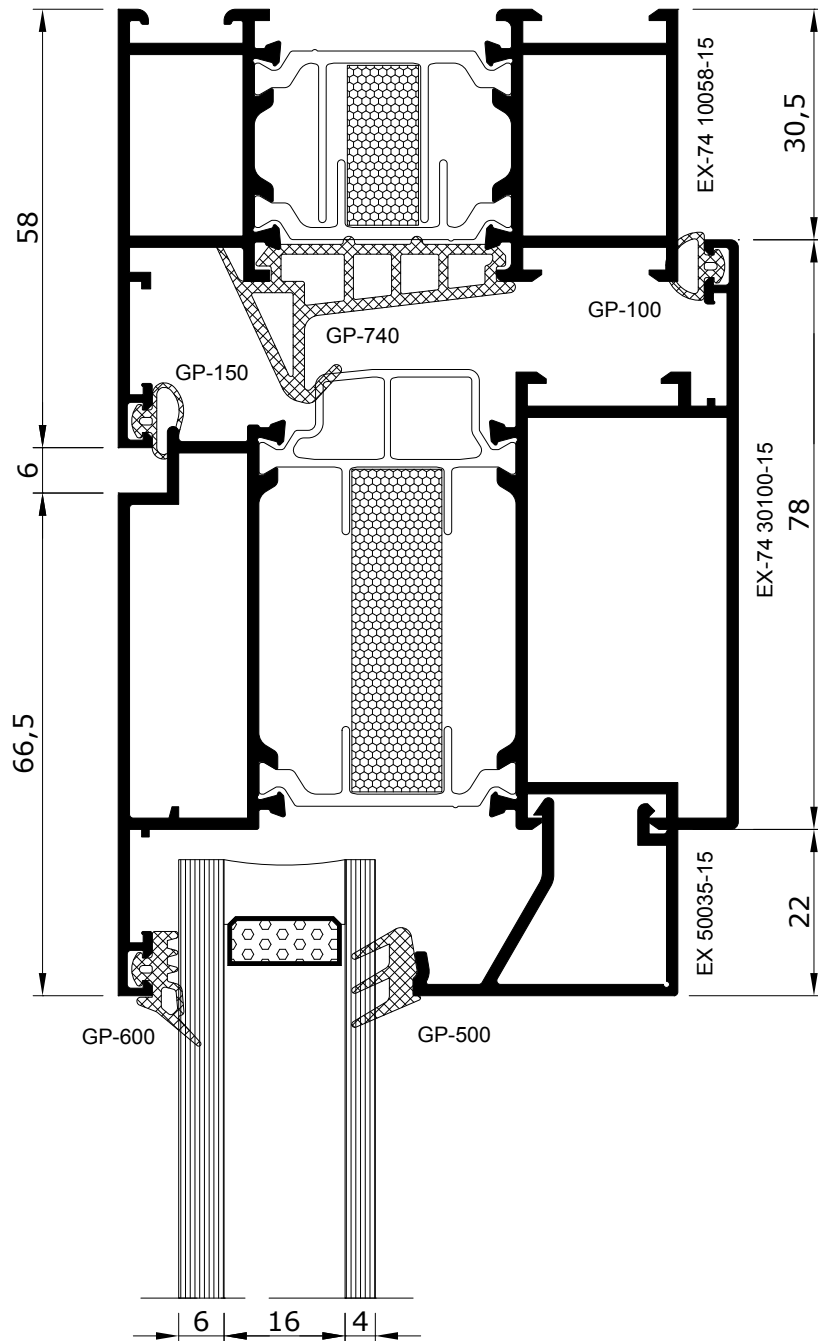
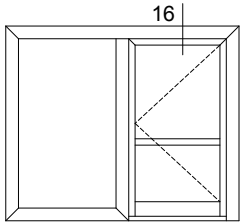

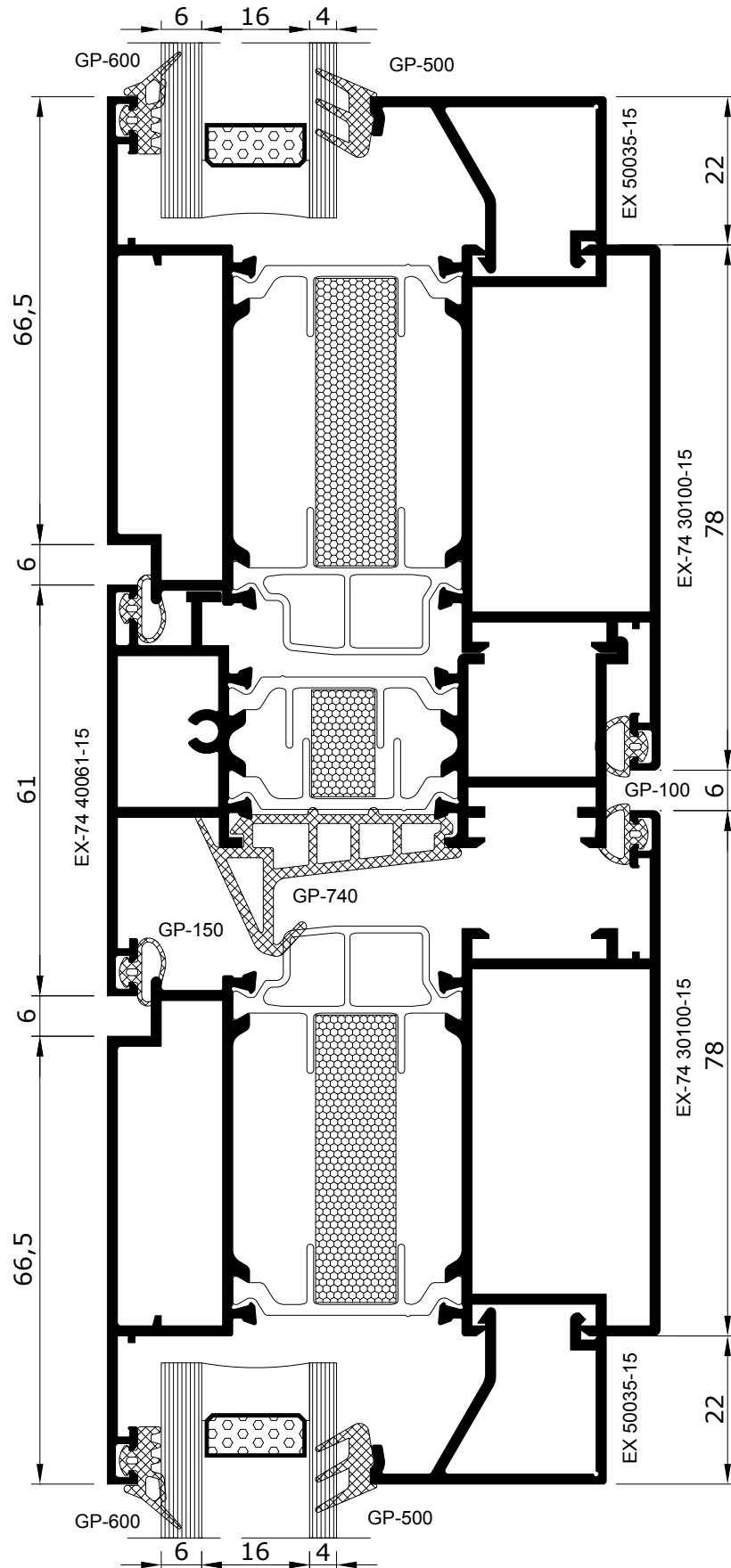
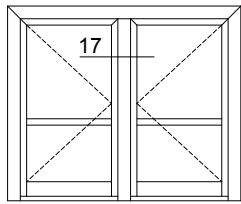

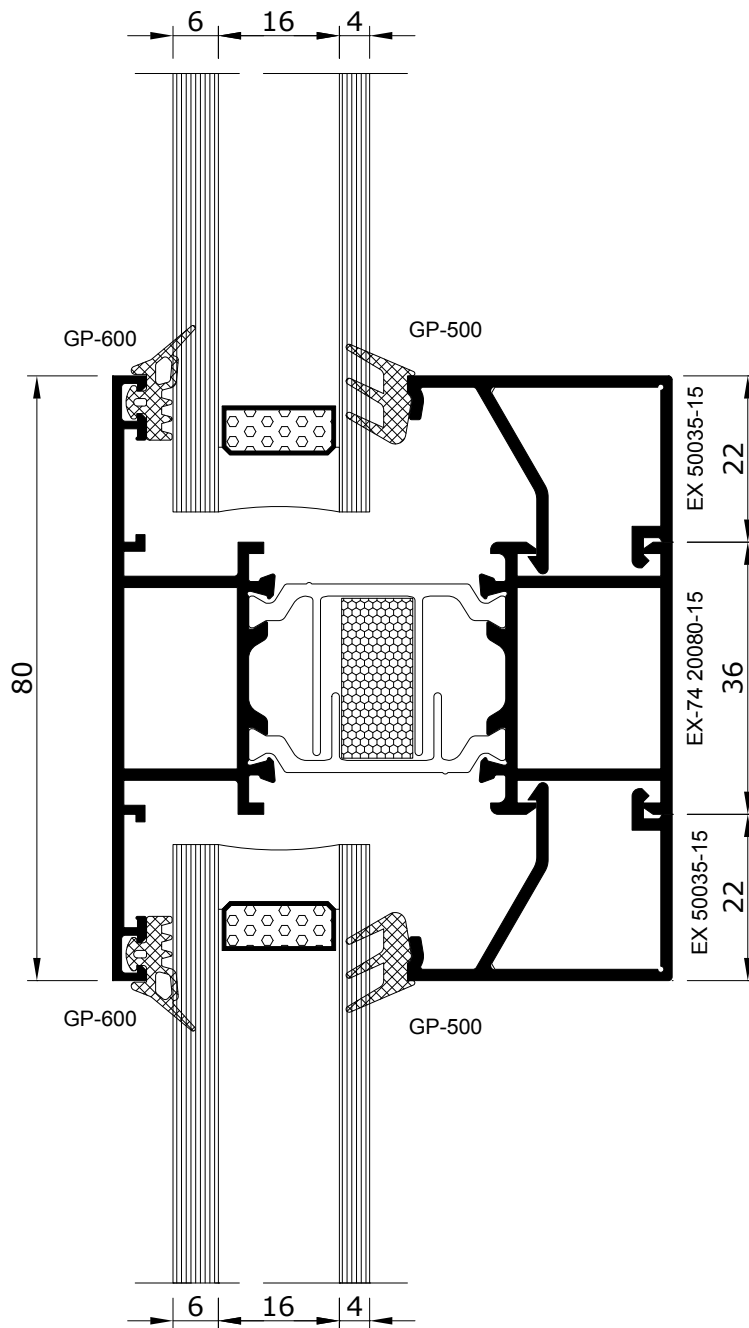
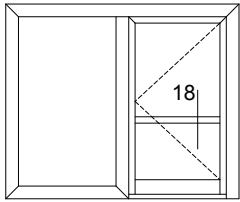

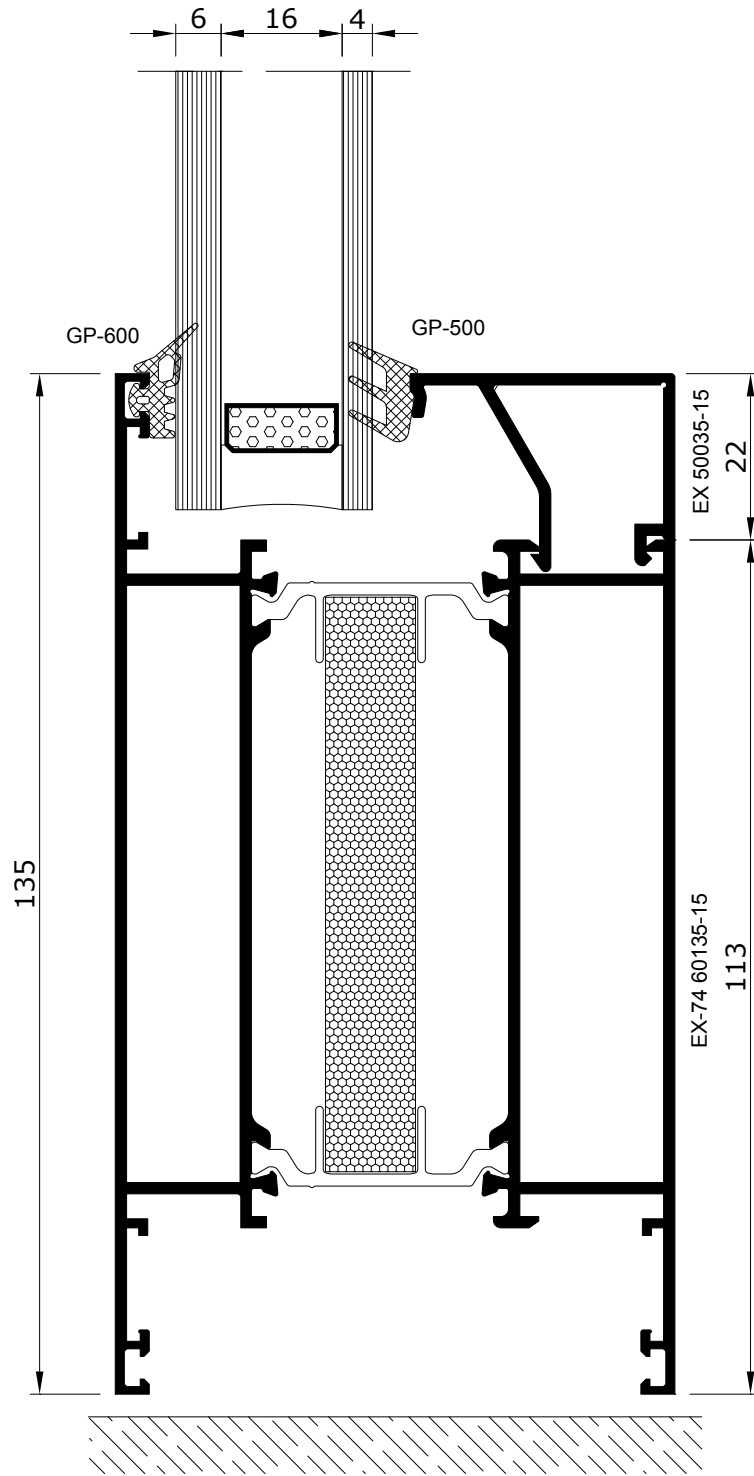
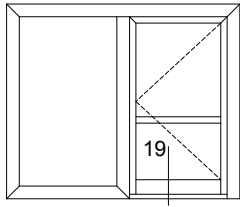

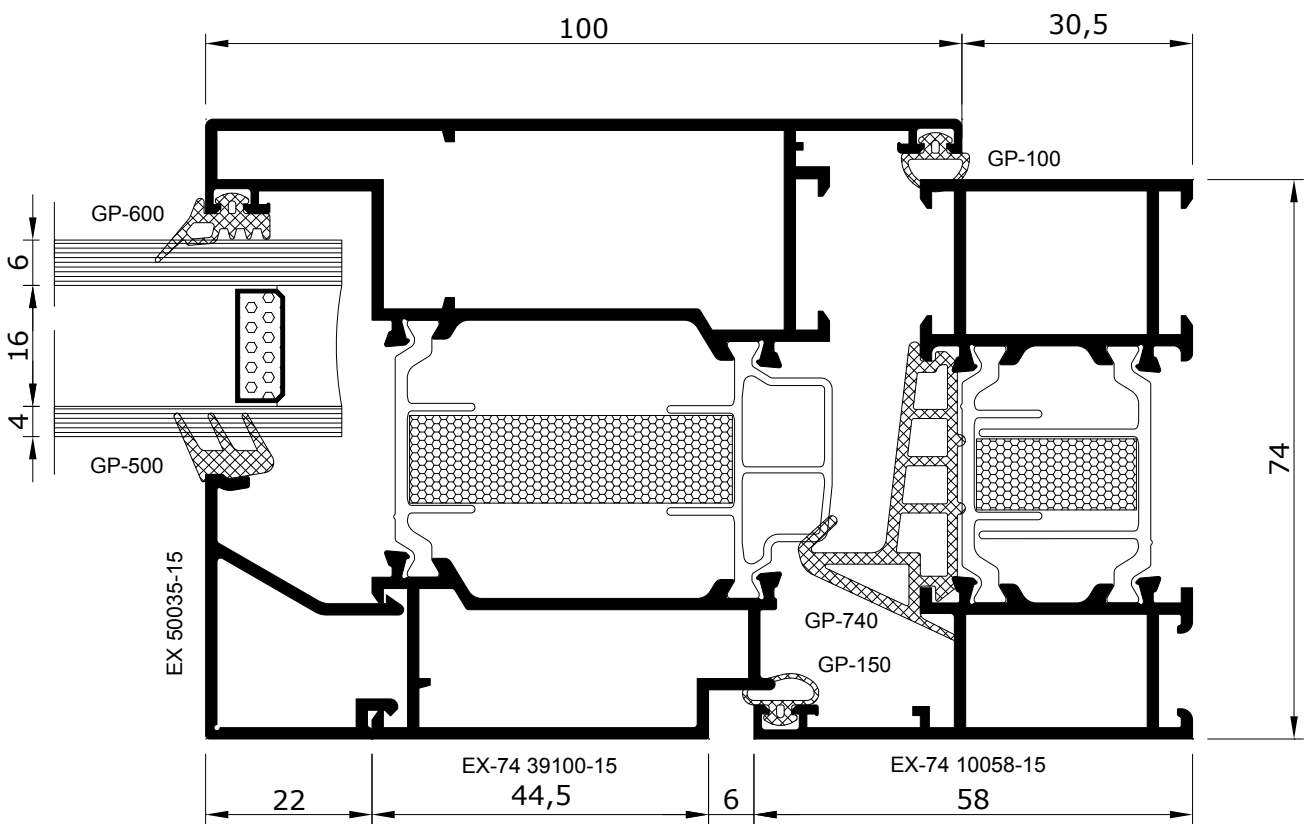
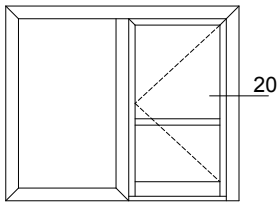

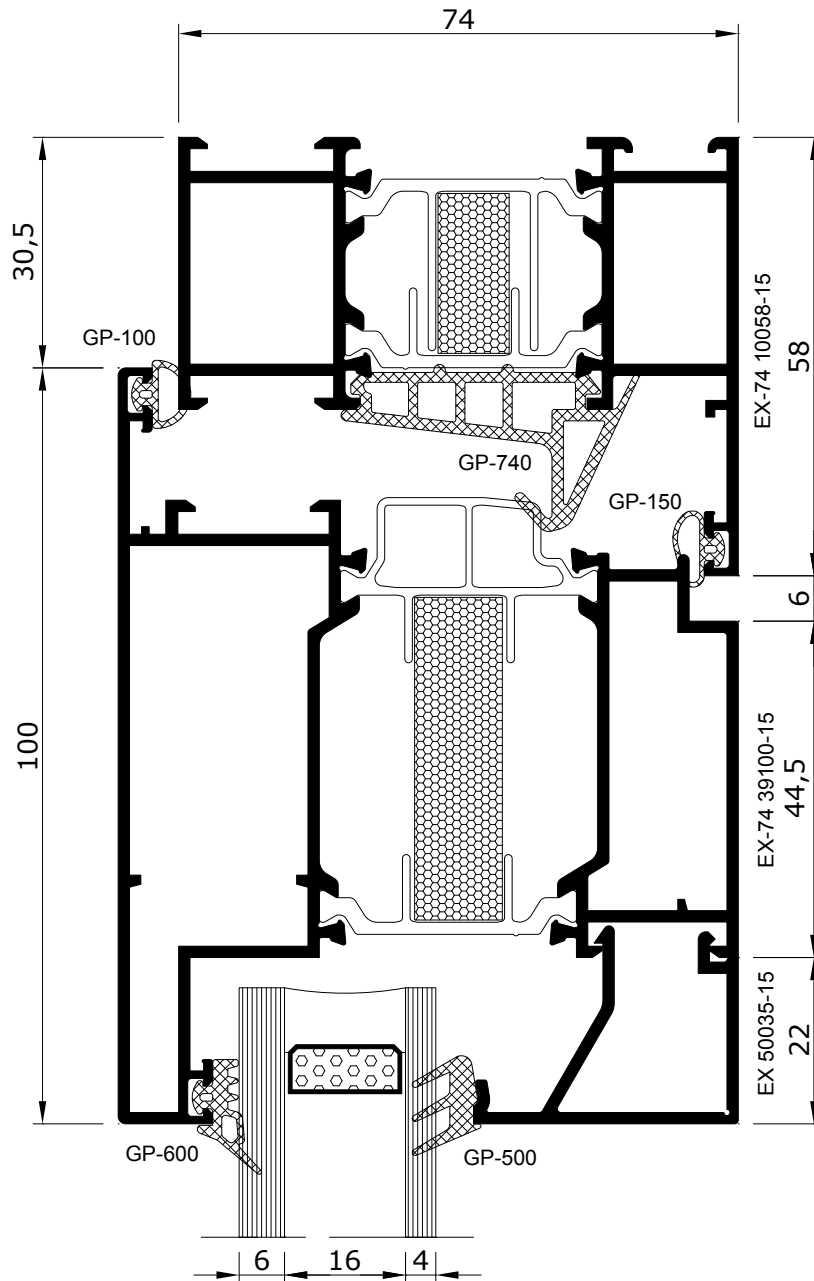
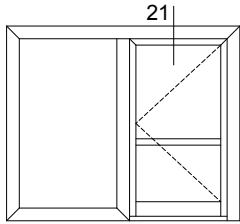

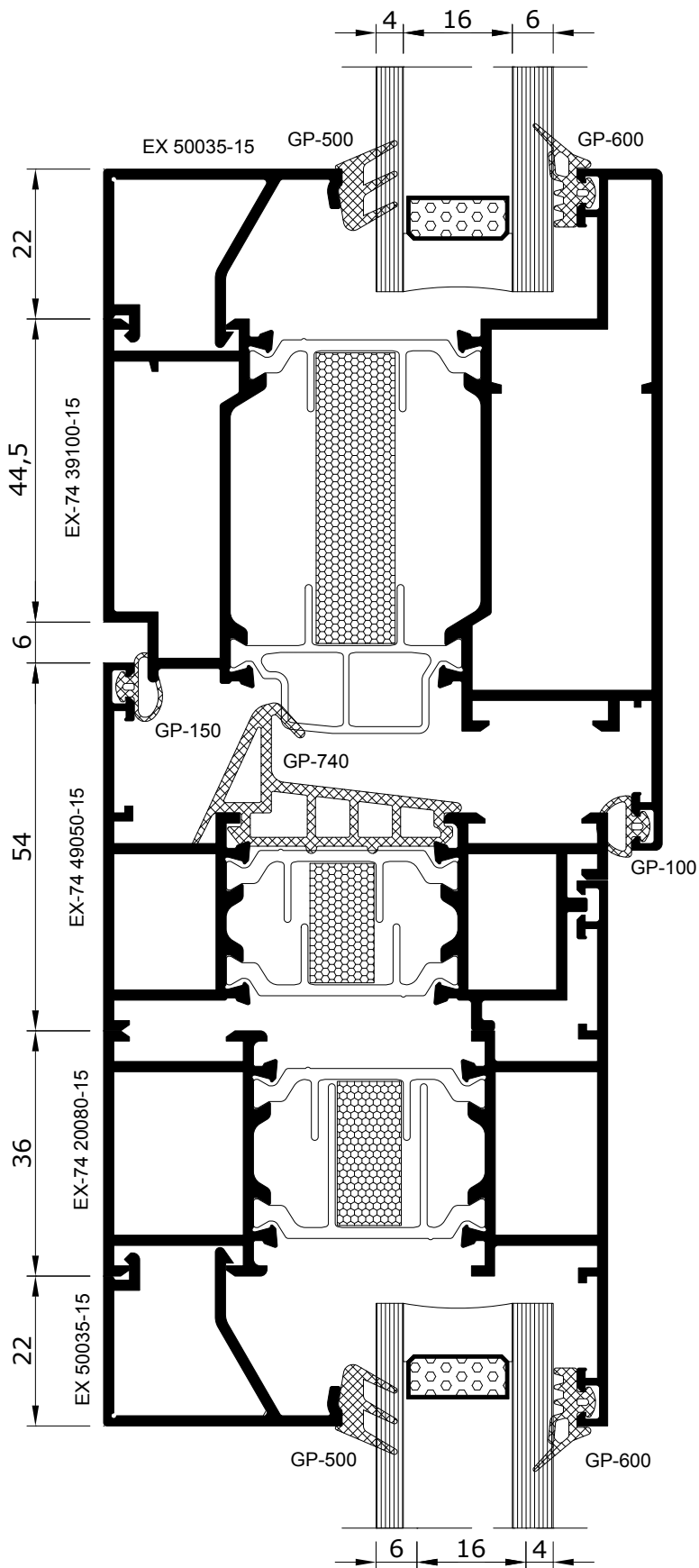
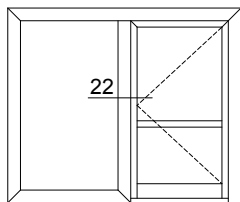

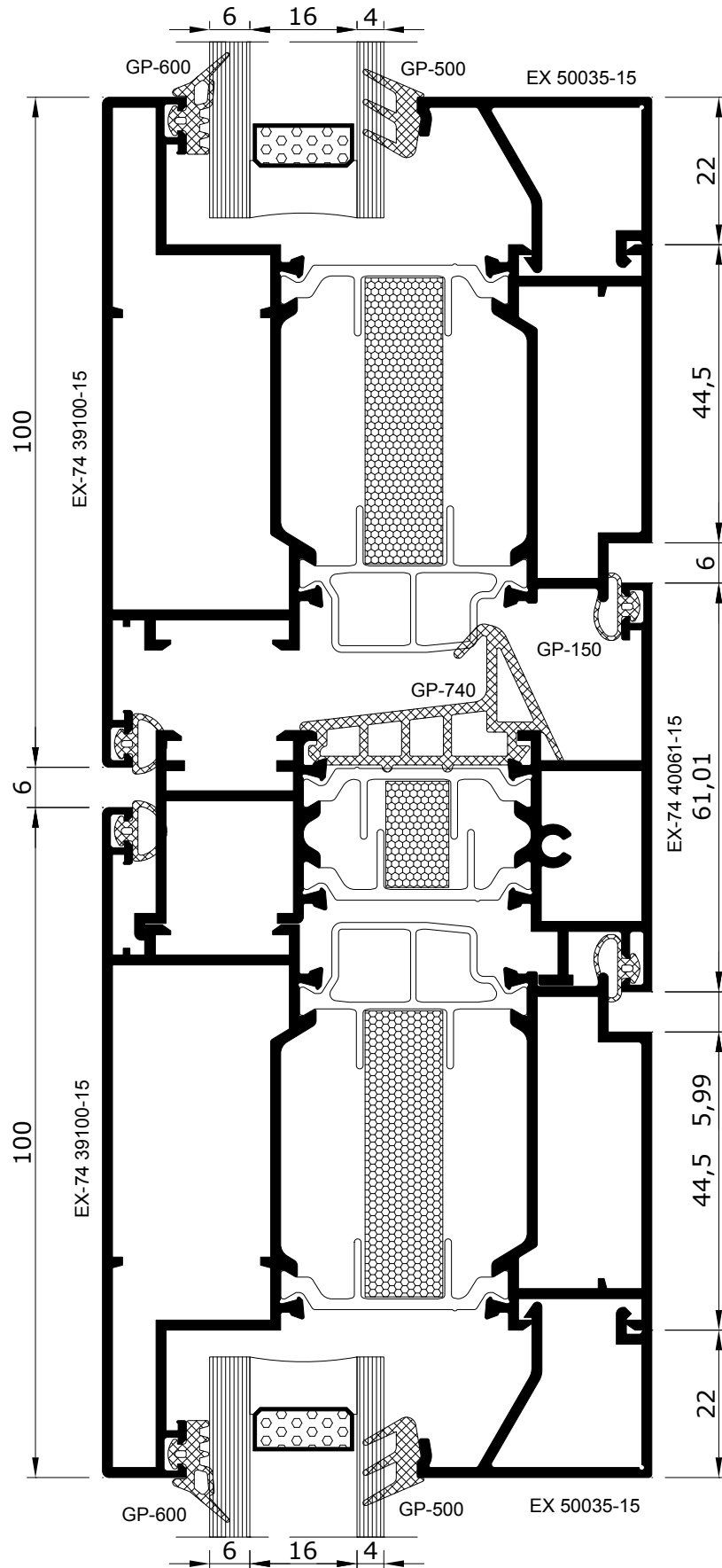
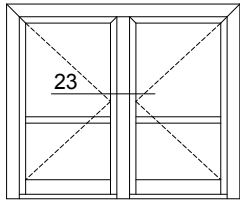



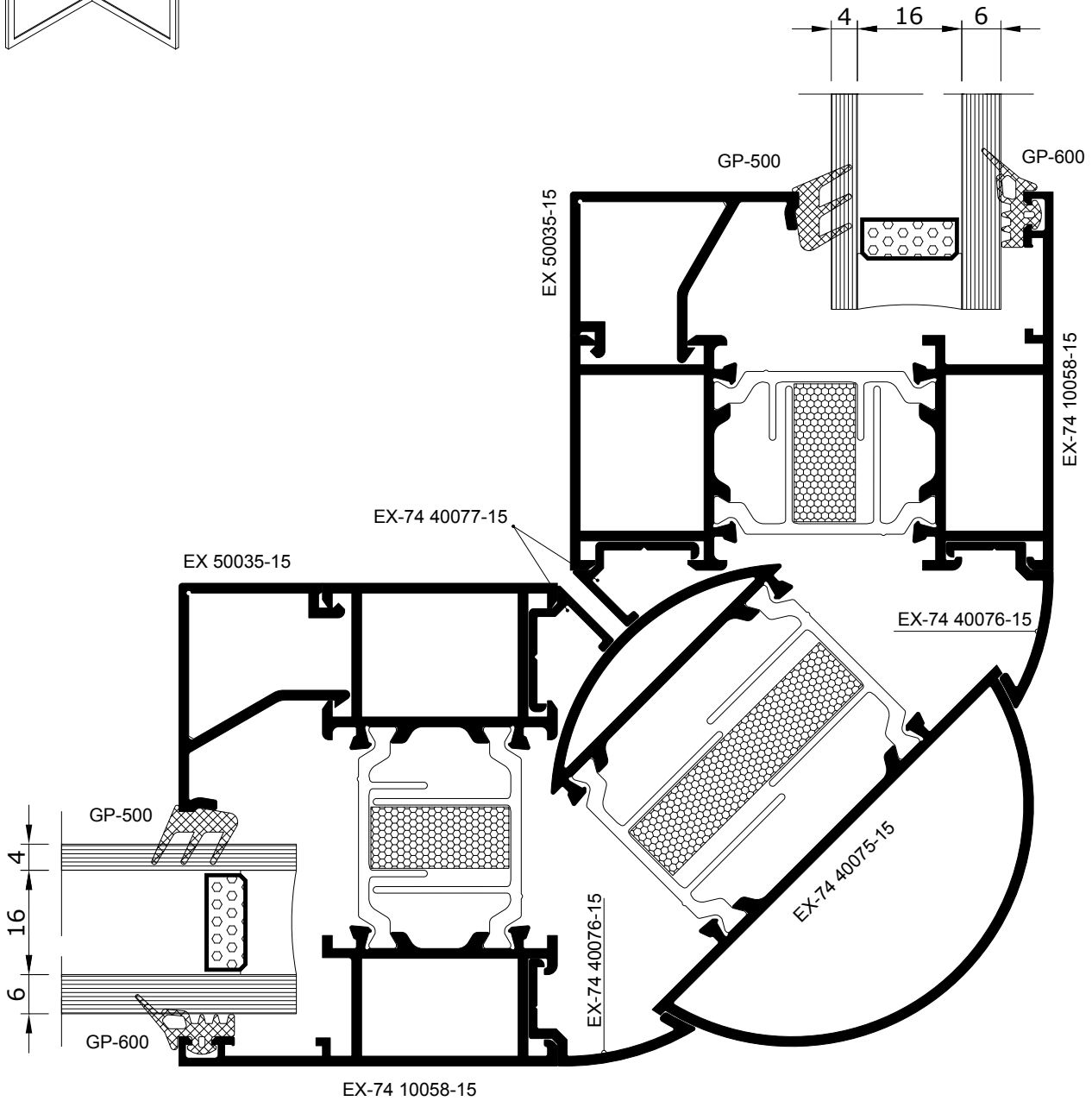
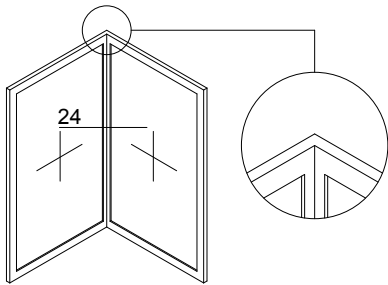

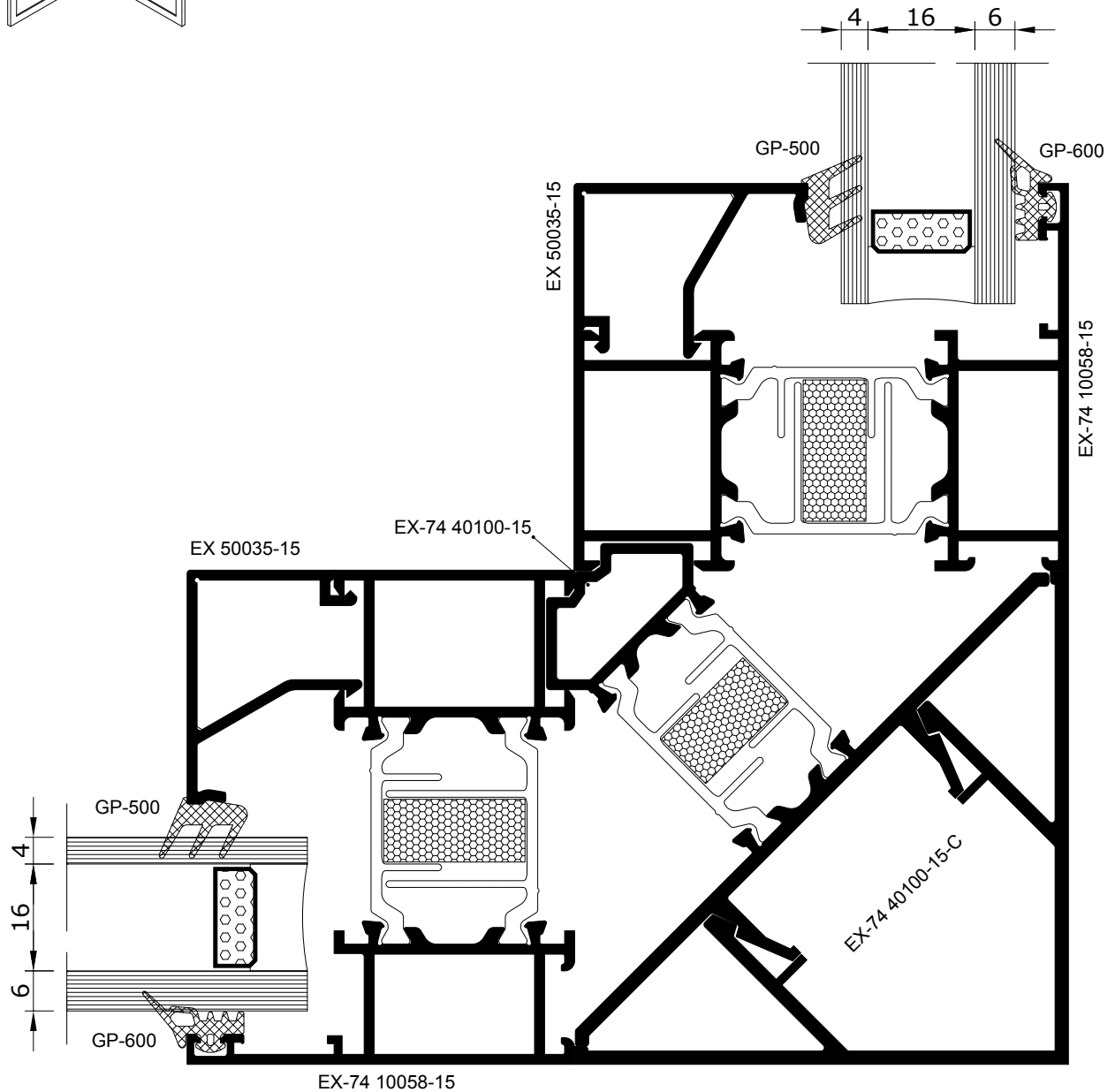
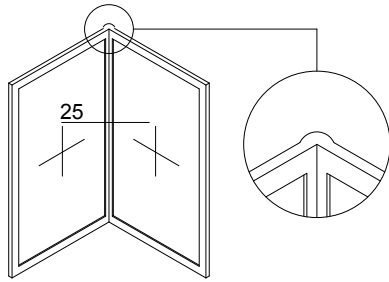

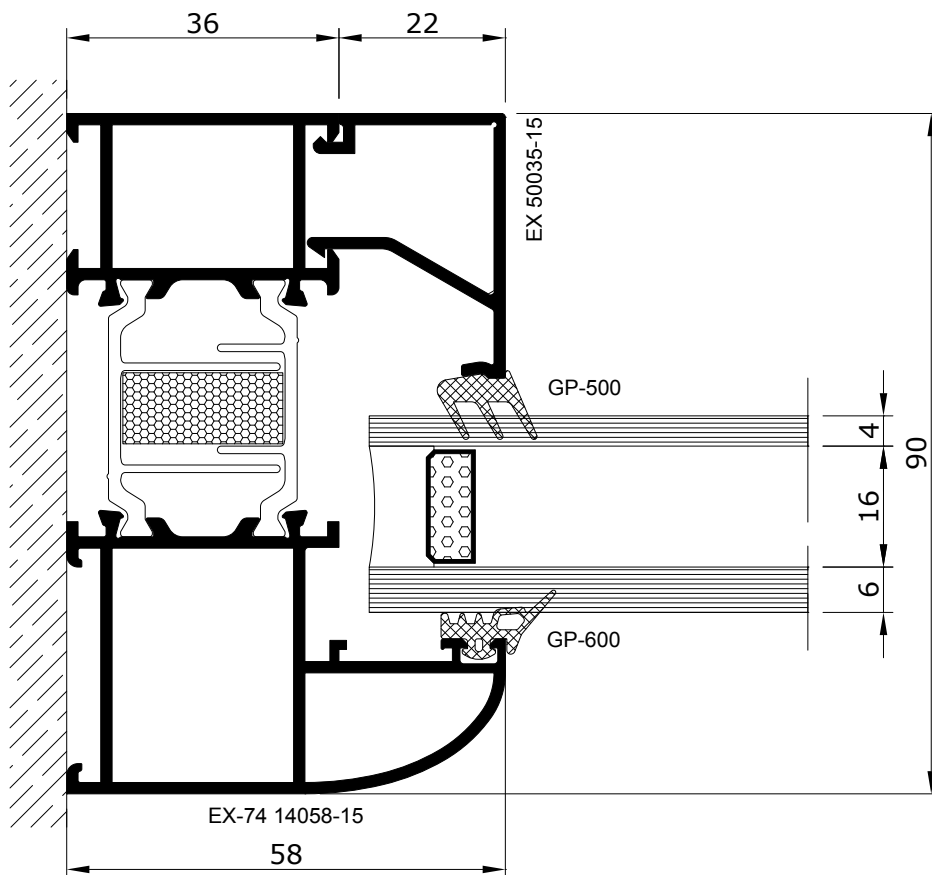
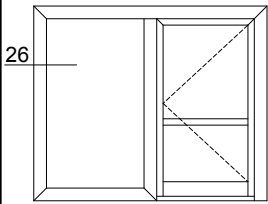

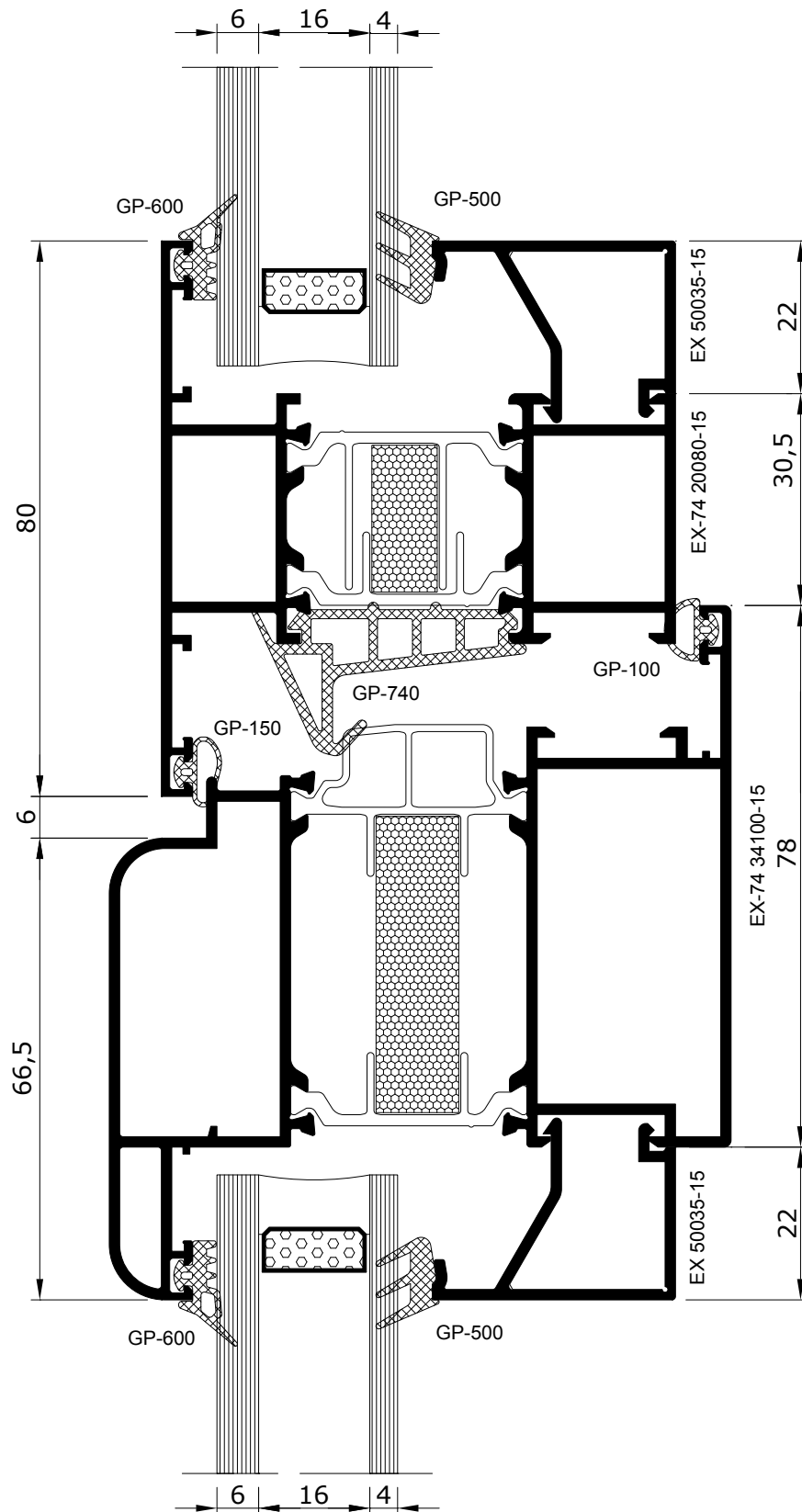
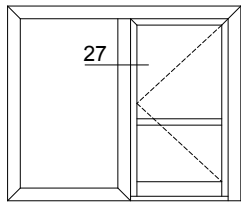

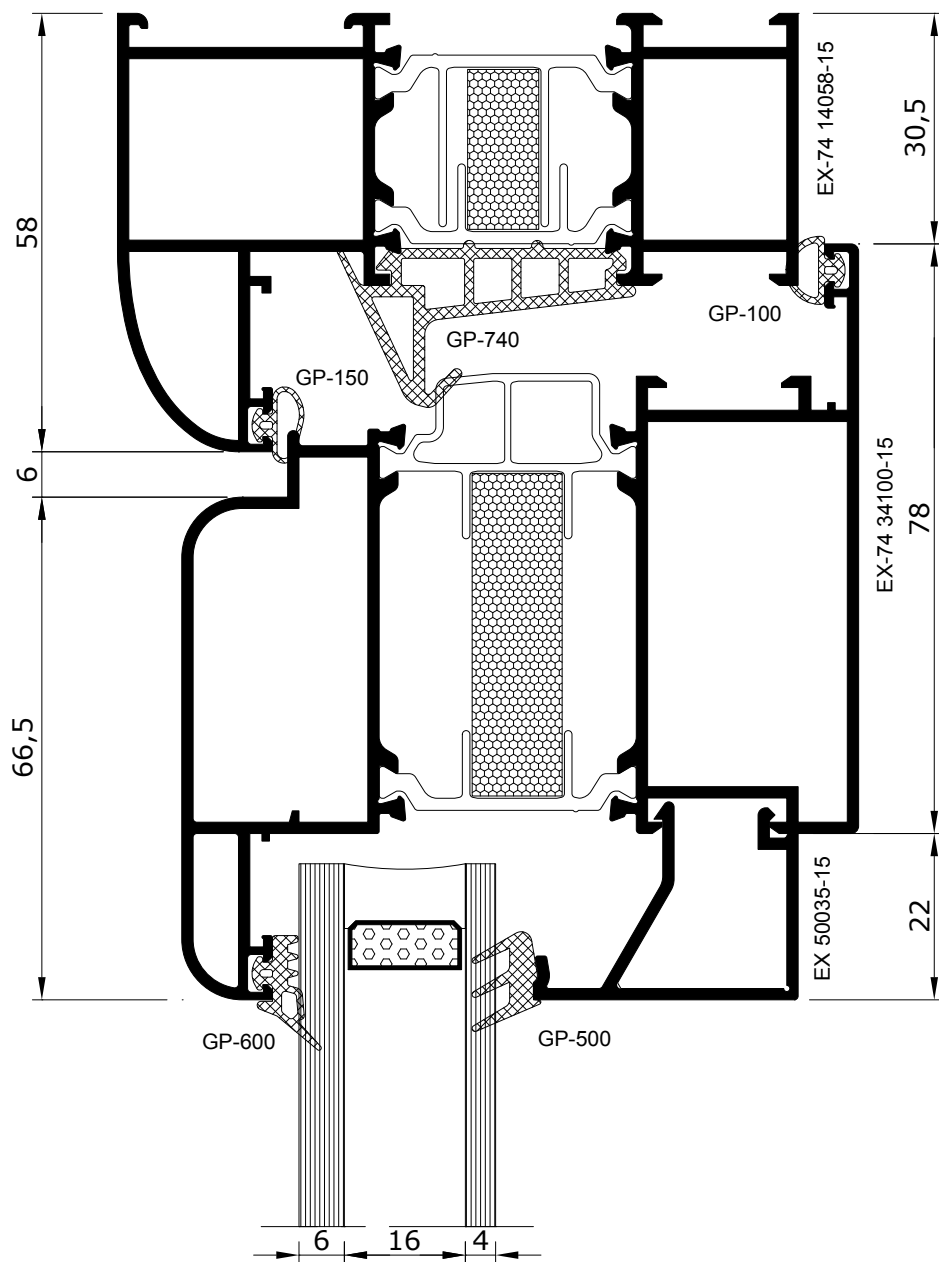
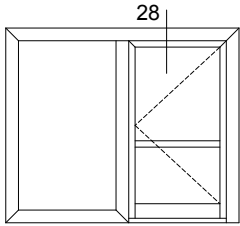

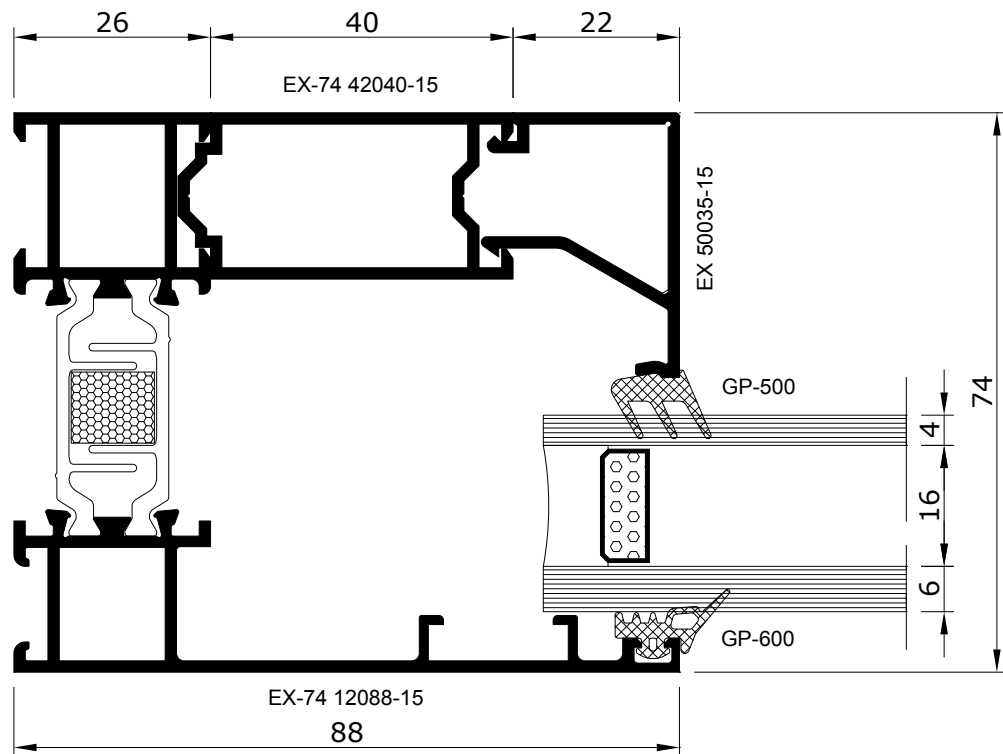
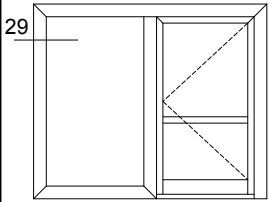

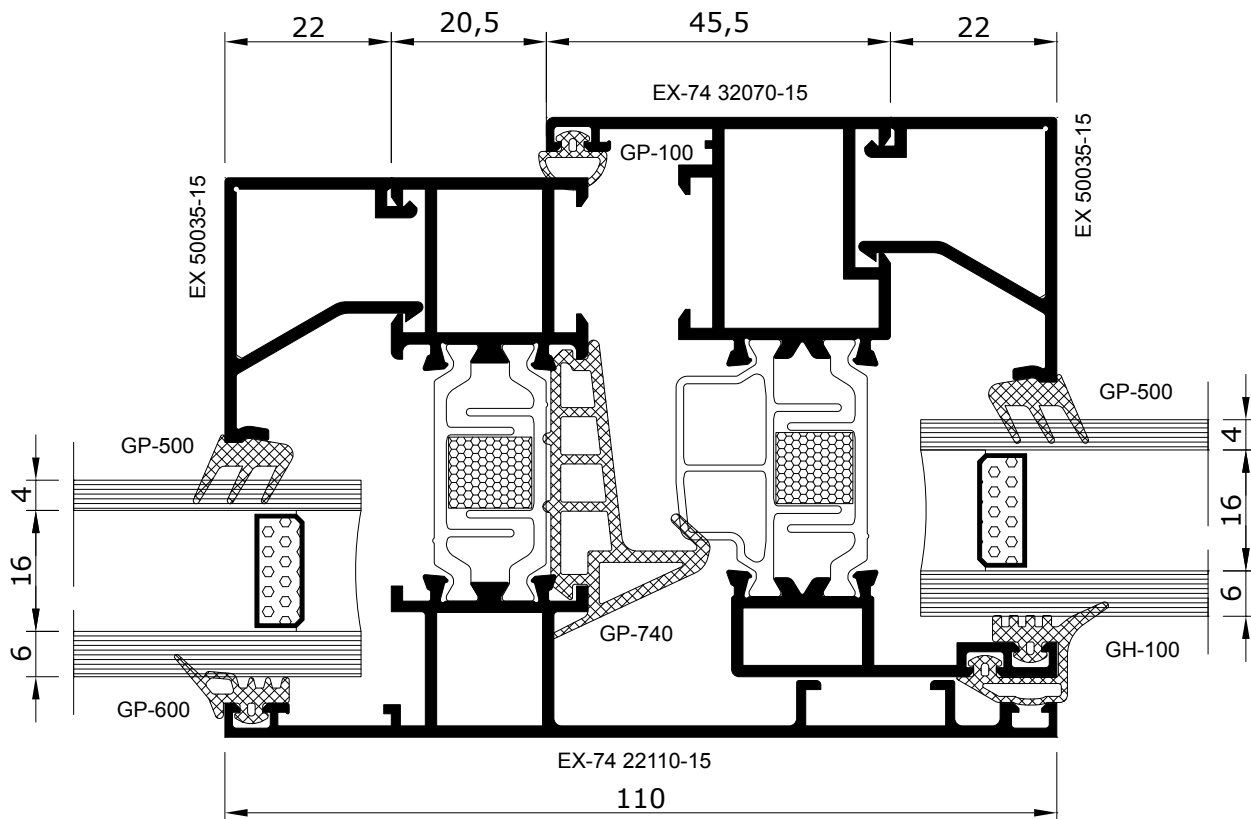
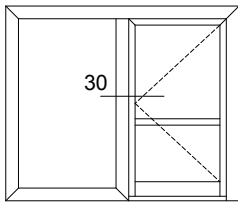

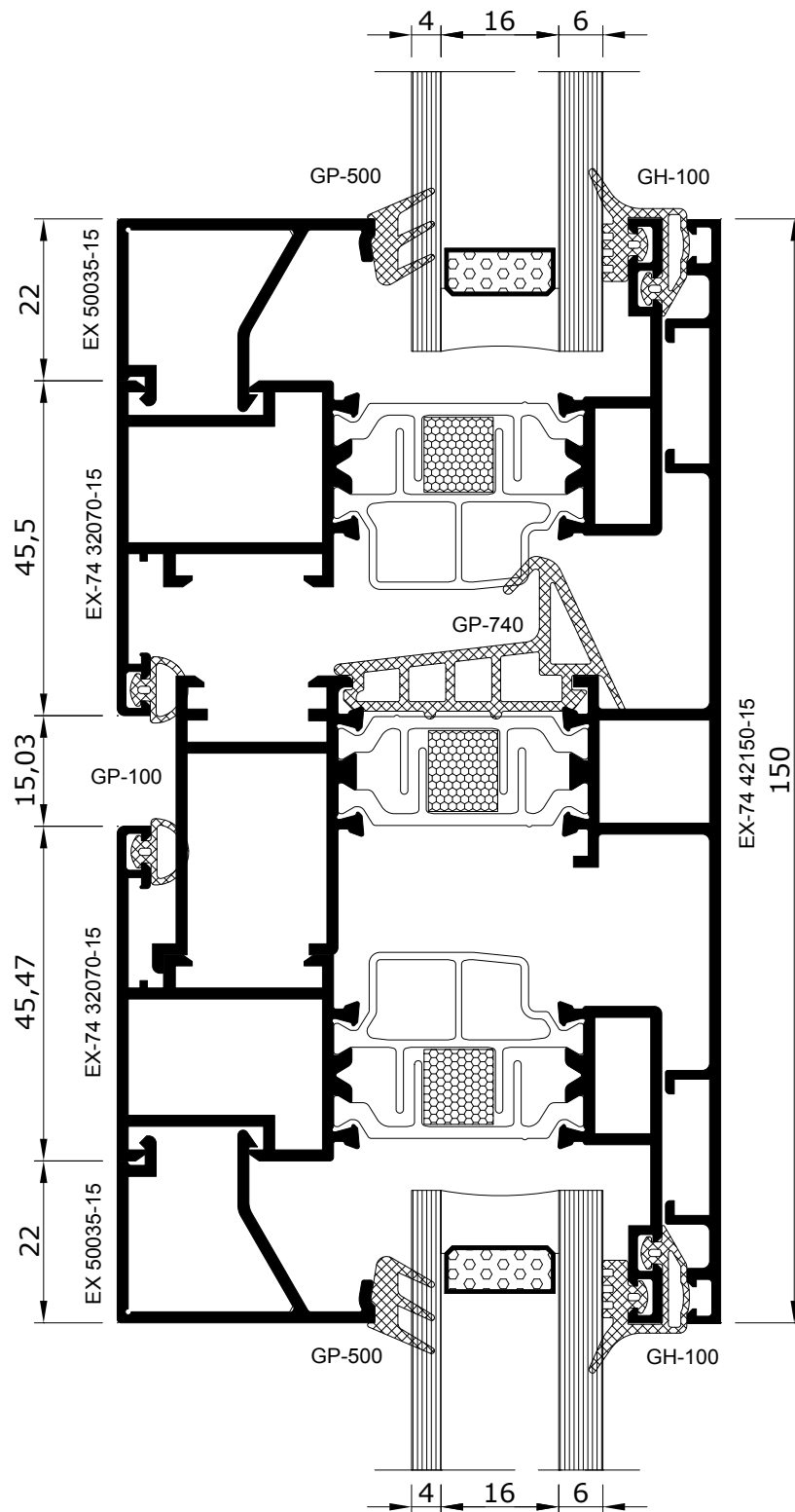
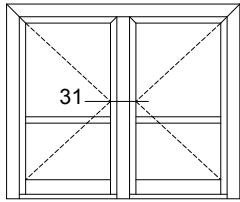



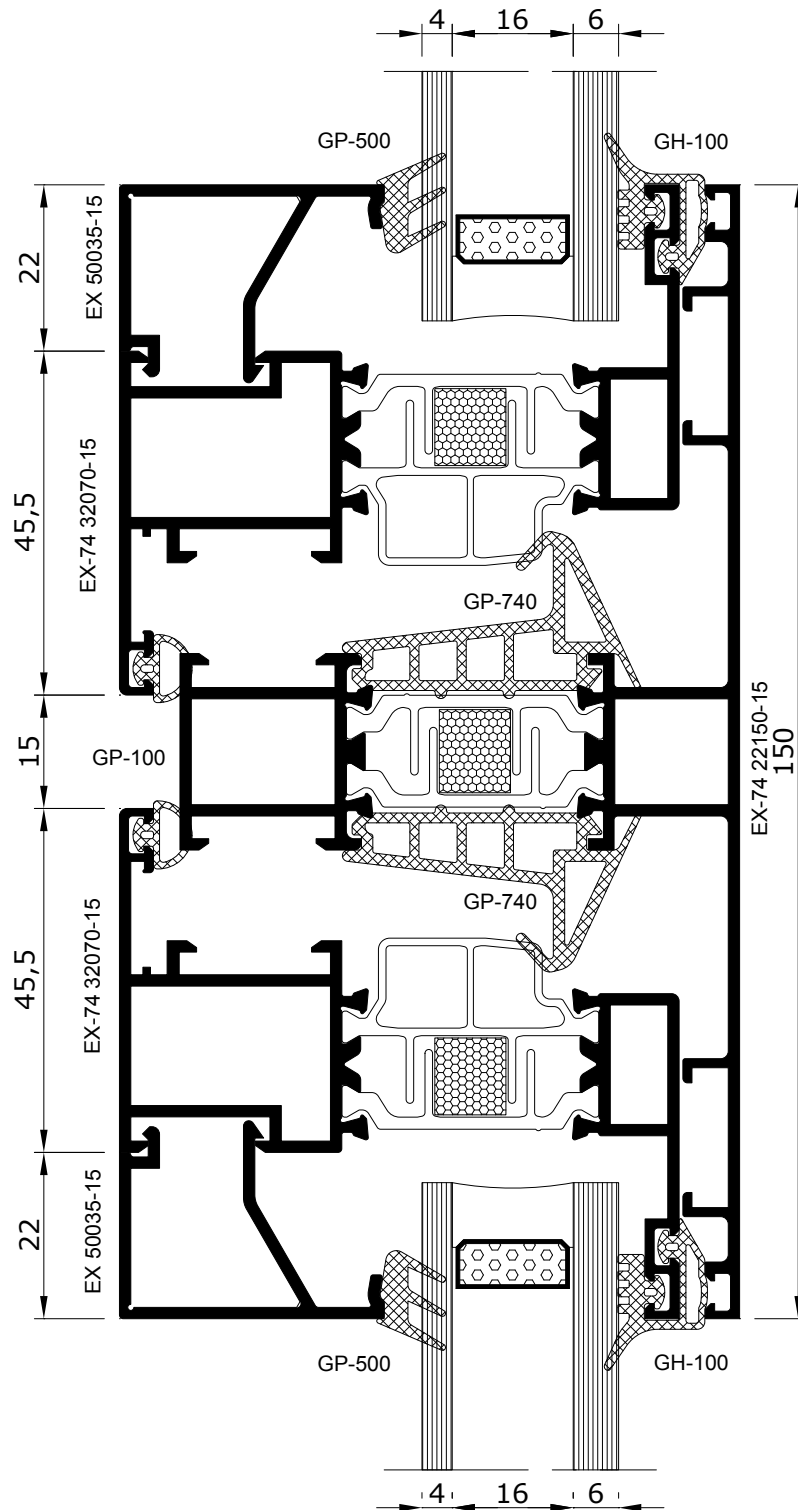
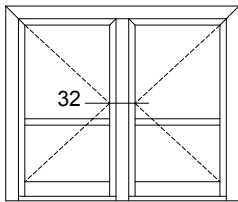

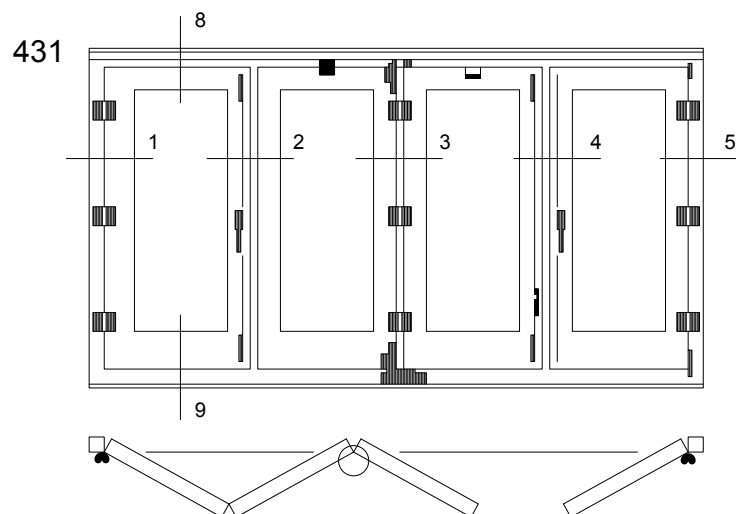
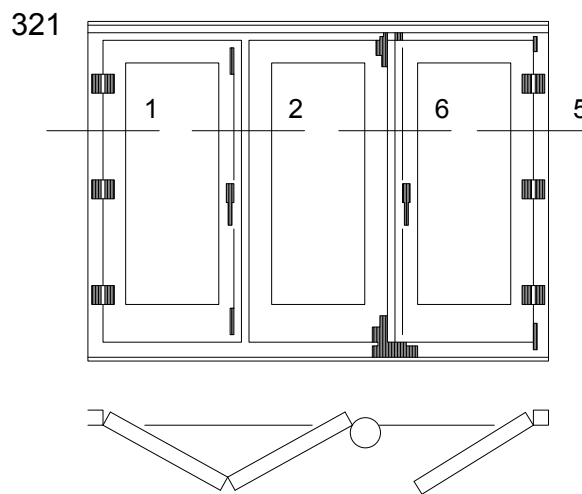
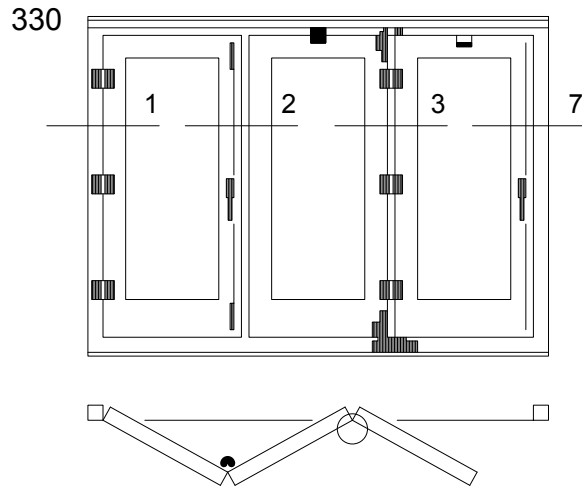

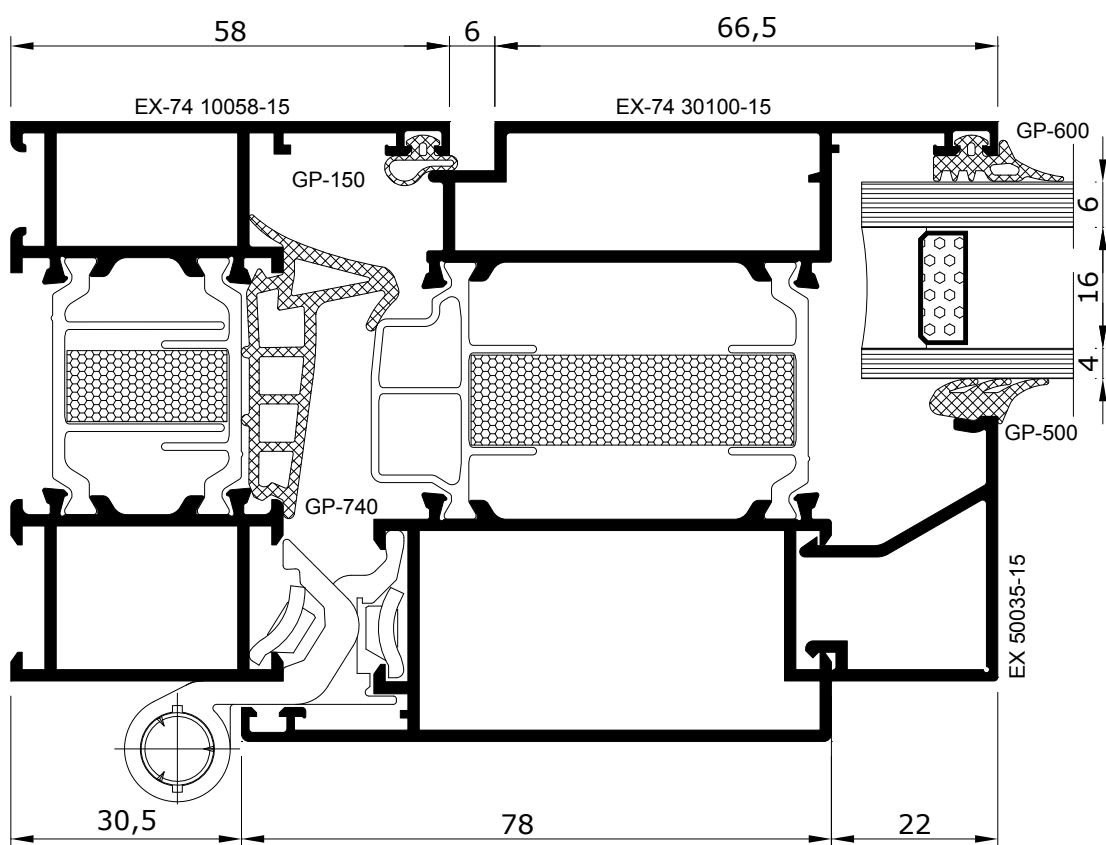

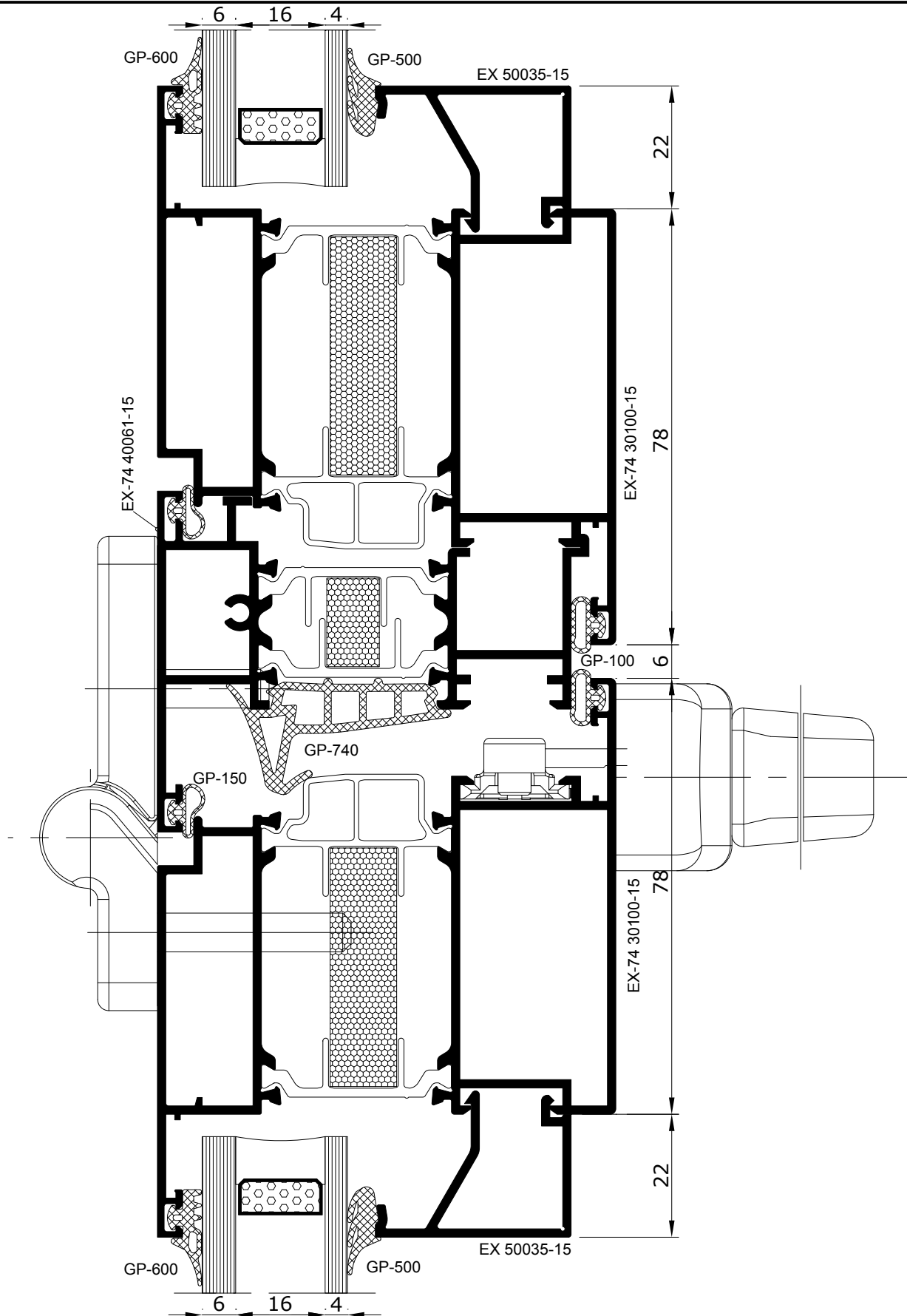

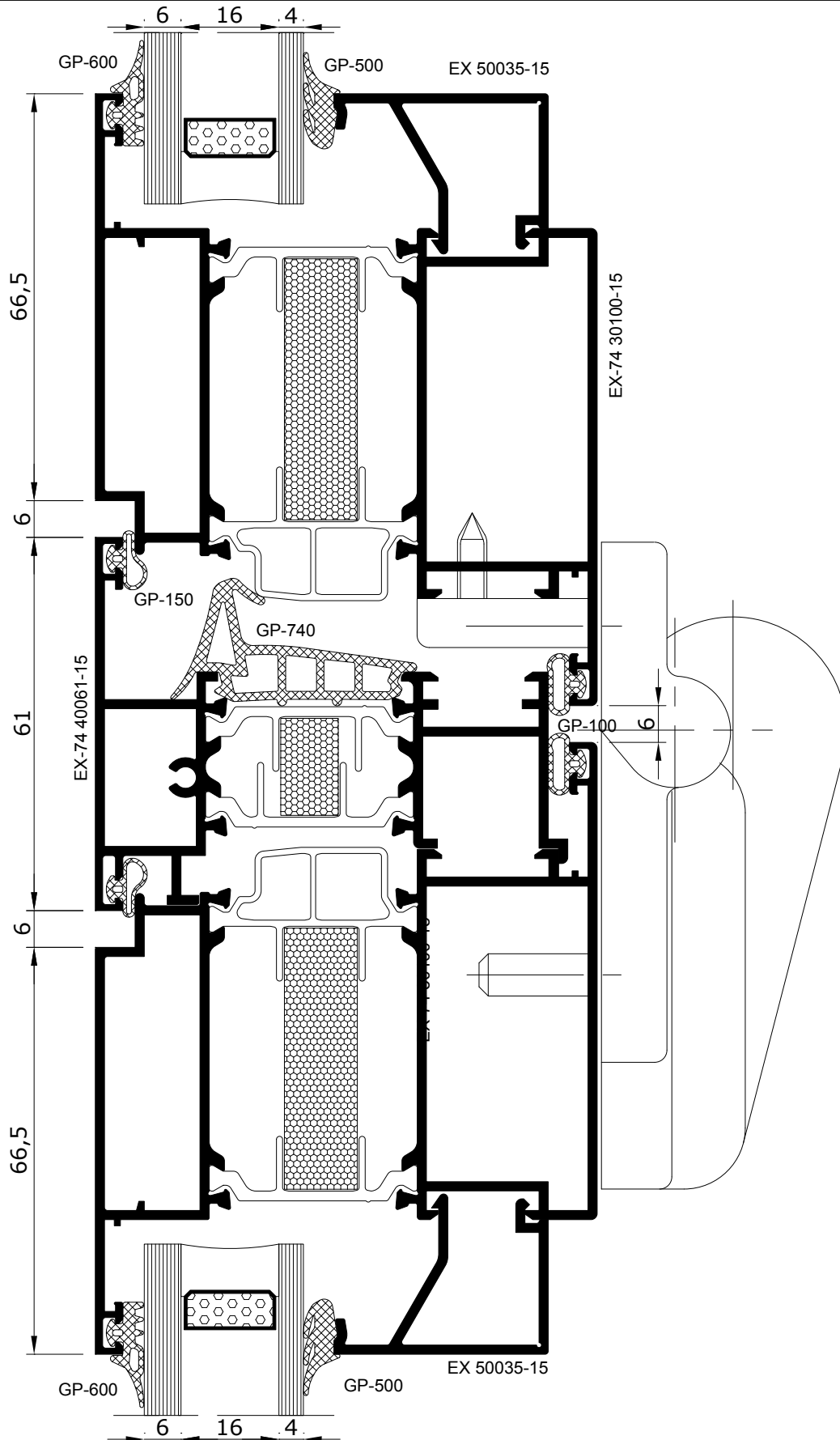

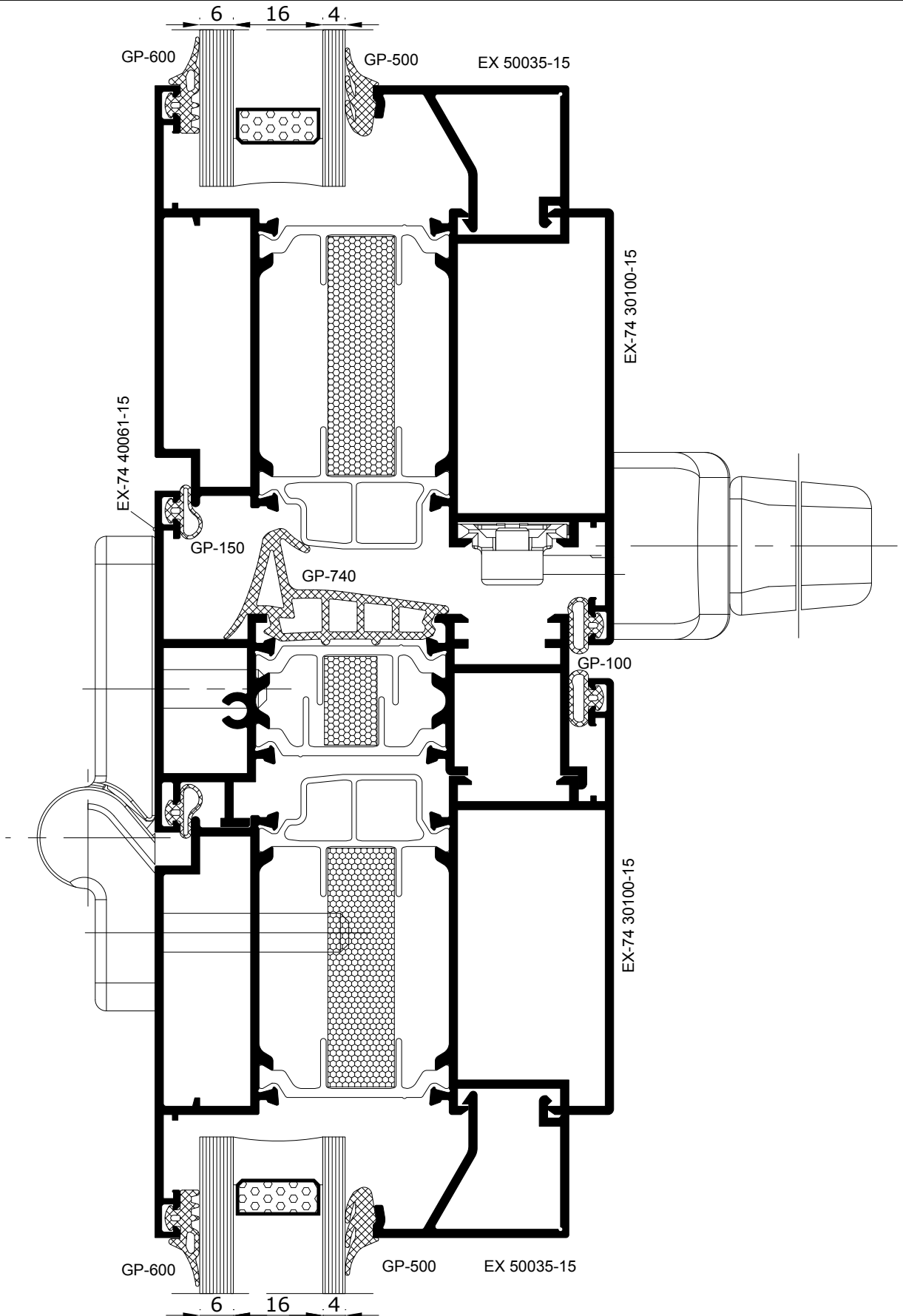

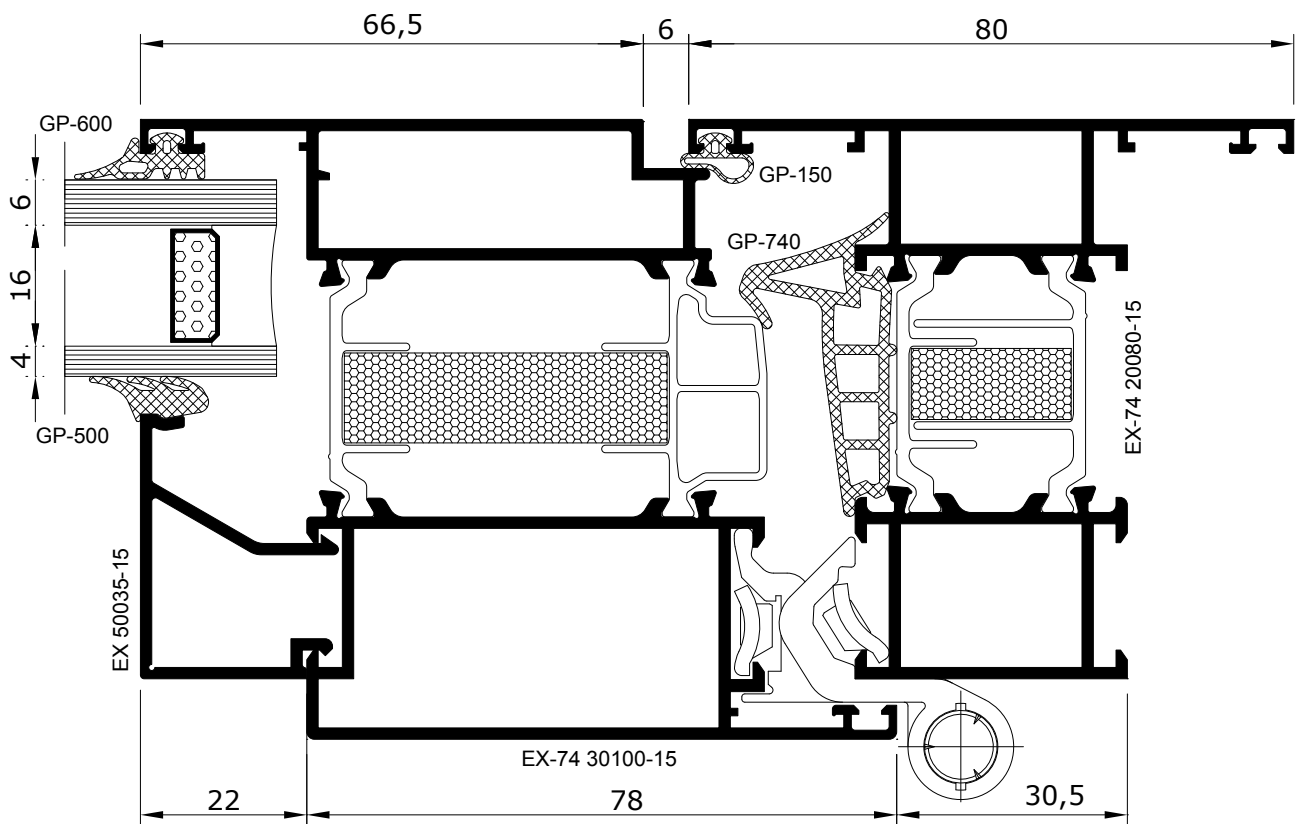

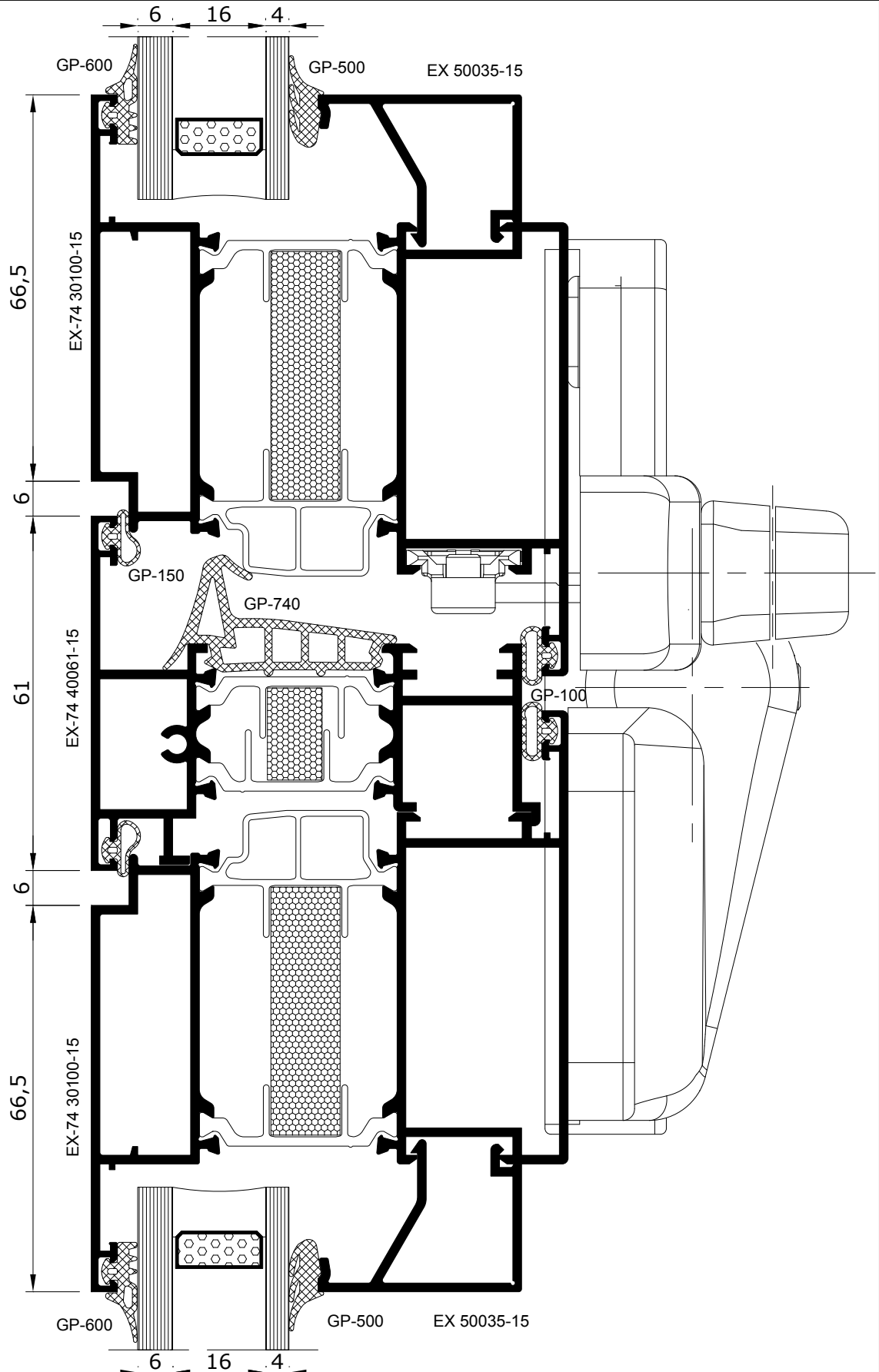



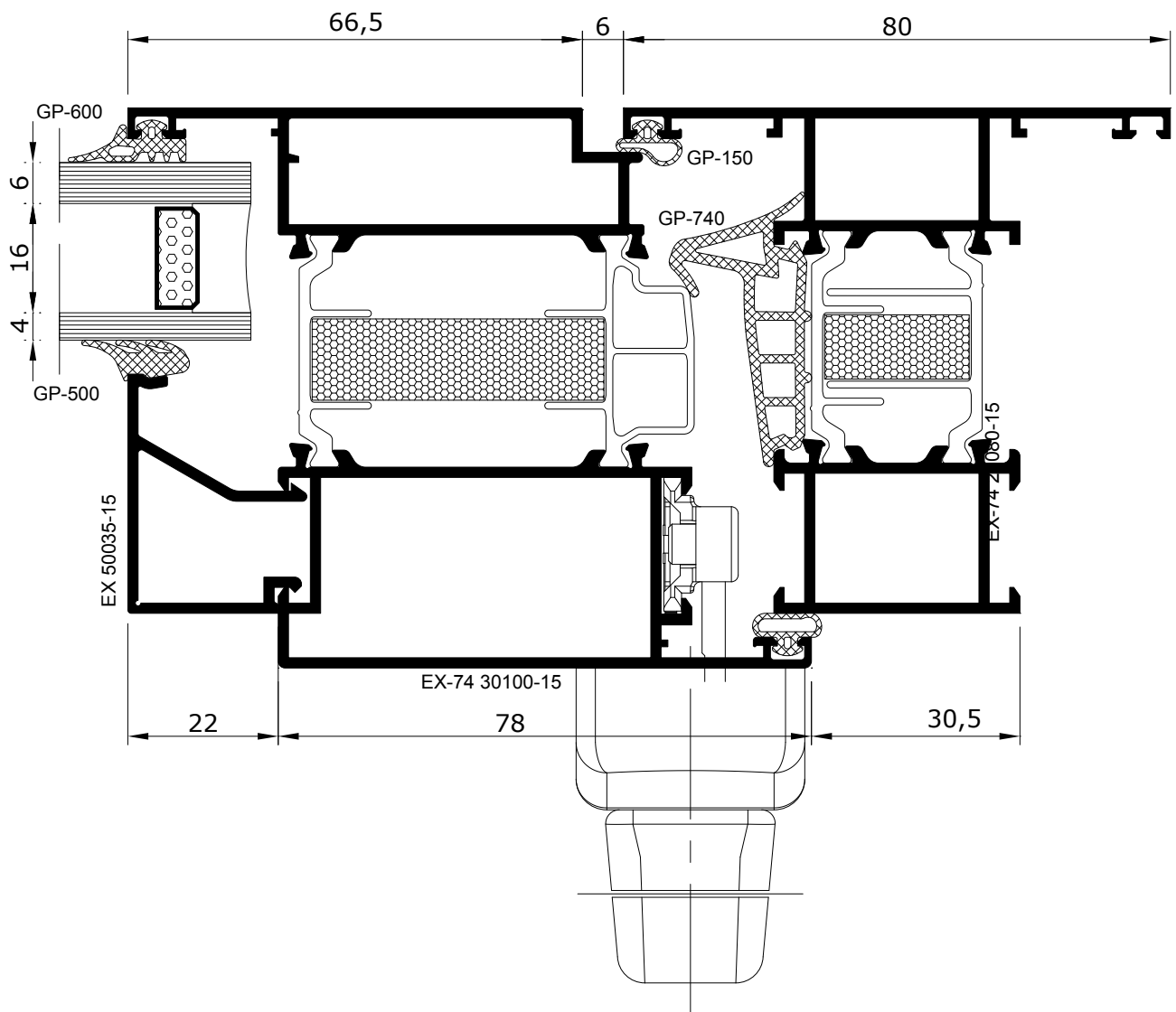

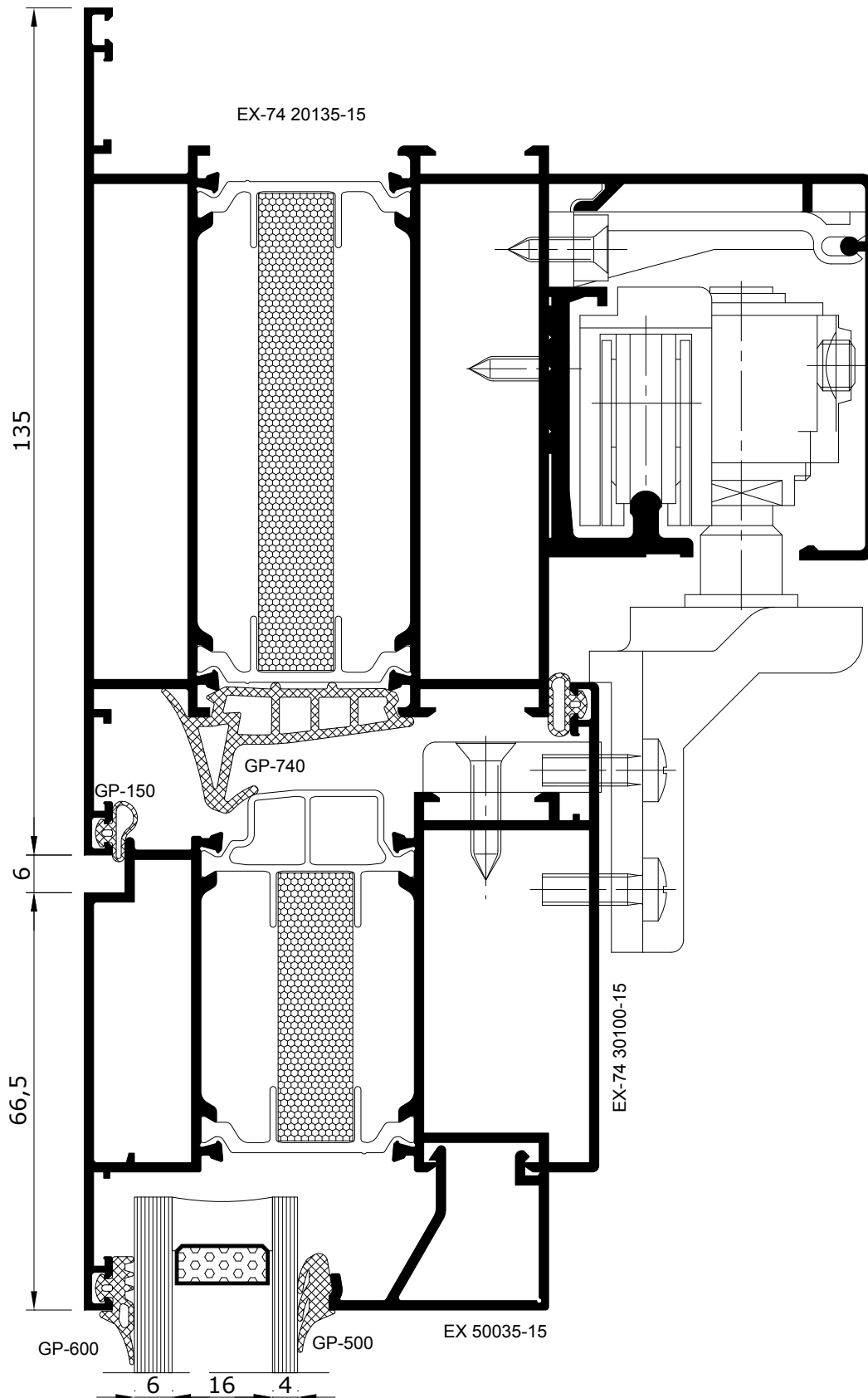

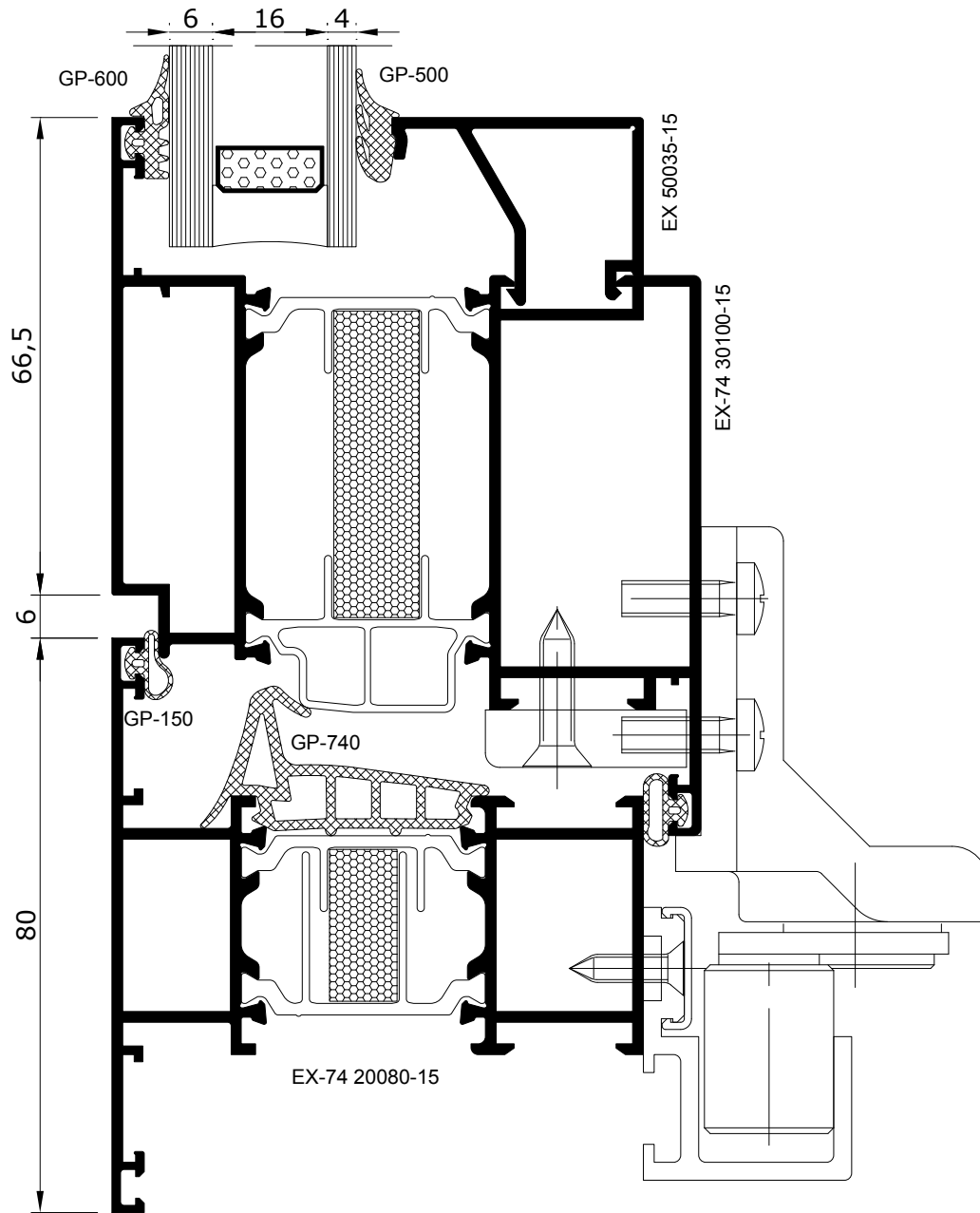

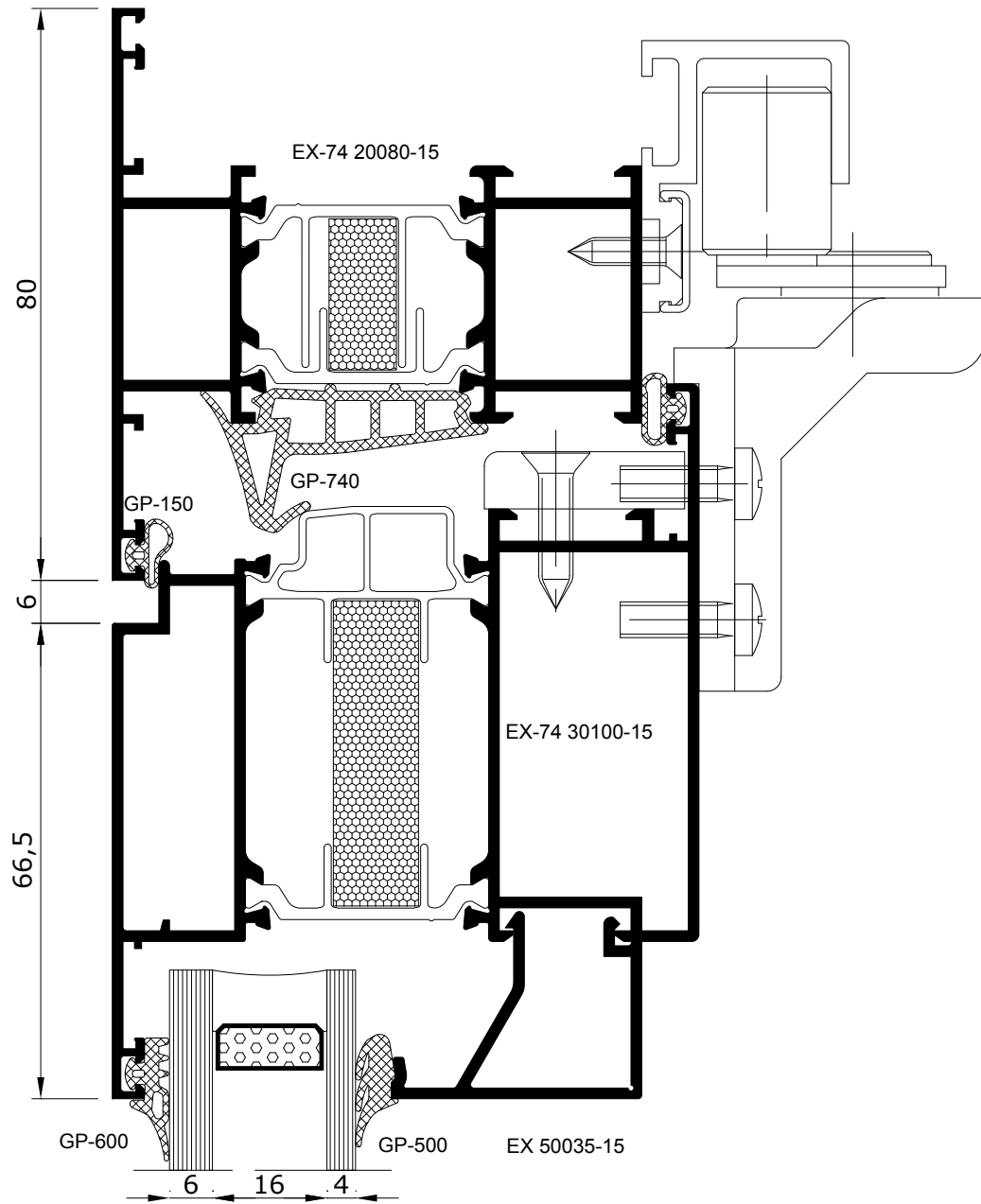

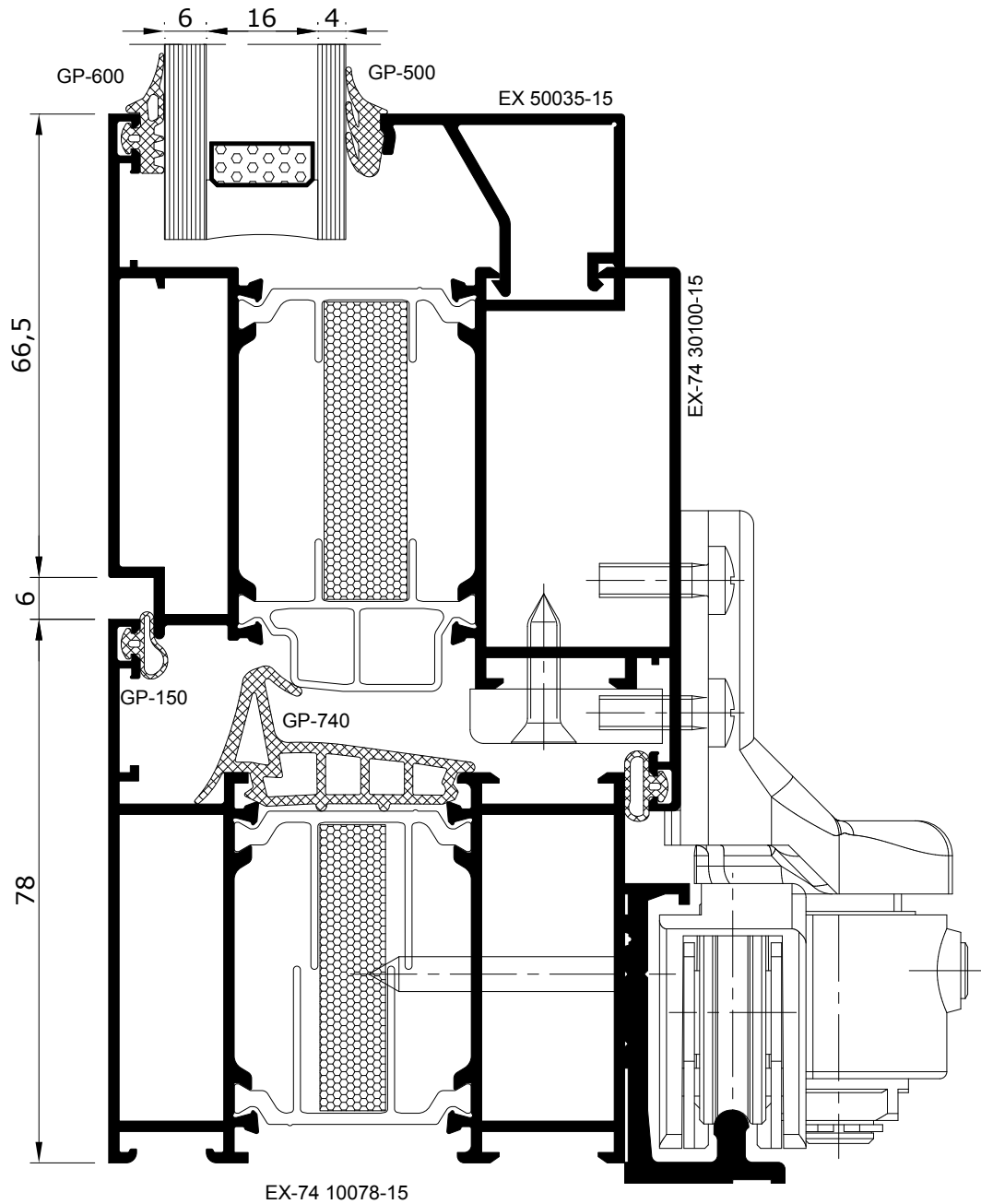



آدرس: زنجان، شهرک صنعتی شماره یک، خیابان پروفیسور ثبوتی، روبروی خیابان آذر جنوبی  
تلفن: ۴ - ۳۳۲۲ ۱۲۶۳ - ۰۲۴  
نمبر: ۱۲۶۵ - ۳۳۲۲ - ۰۲۴

**Add:** Professor sabouti St., No.1 Industrial Zone, Zanjan, iran

**Phone:** +9824 3222 1263 - 4      **Fax:** +9824 3222 1265

[www.exalaluminium.com](http://www.exalaluminium.com)

[info@exalaluminium.com](mailto:info@exalaluminium.com)