

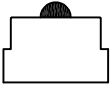

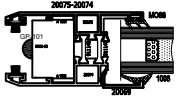

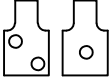

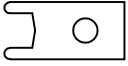

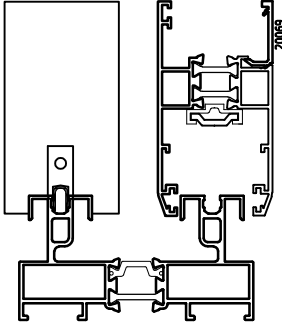

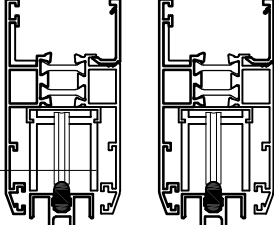

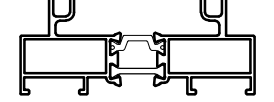

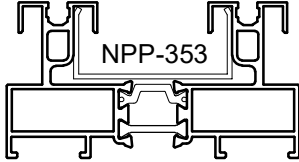
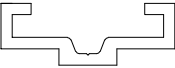
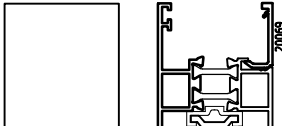
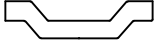
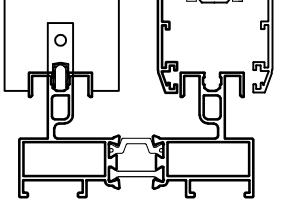

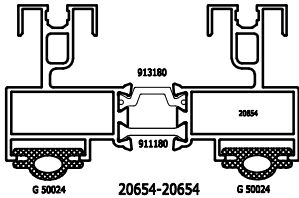

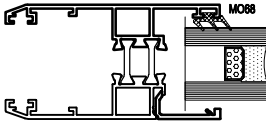

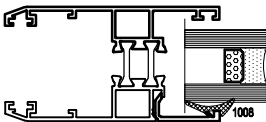

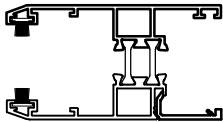

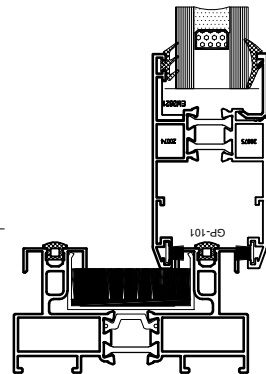

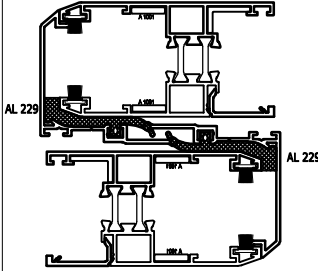

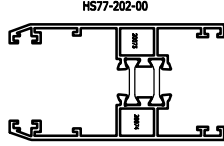
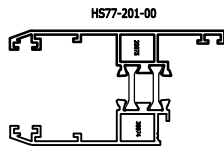

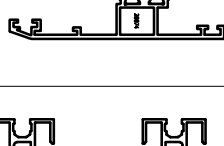
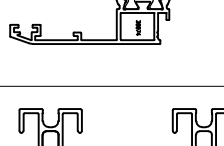

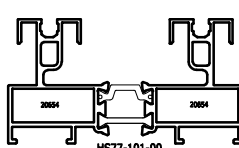
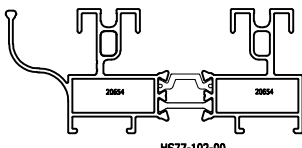

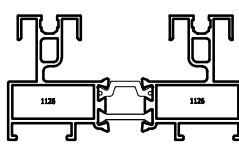
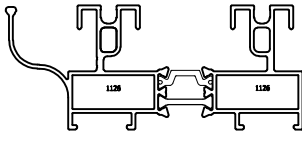

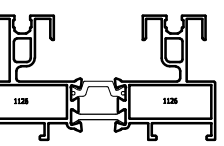
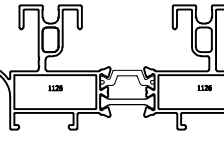

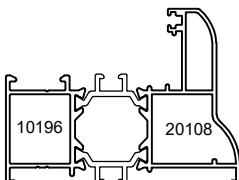

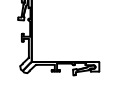

**THS77**

PICTURE	ACCESSORY CODE	APPLICATION PROFILES	APPLICATIN DETAIL	DESCRIPTION	
	EM38-23	STOPER		یاب ددع ود وشزب گیل بتبٹ گیل	وگ بمرض
	370005	LOCKER		یاب نفج کی بتبٹ گیل	ک فی کس لپ
	EM38-24	Cover Clip			ش پرد کس لپ
	EM38-32	Pulley With 2Wheels			
	20068	SSR-001			
	NPP-353				
	20614				
	5930				

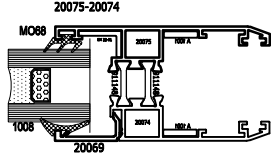
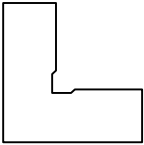
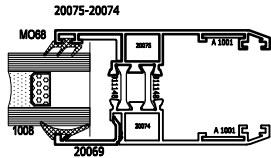
PICTURE	ACCESSORY CODE	APPLICATION PROFILES	APPLICATIN DETAIL	DESCRIPTION	
	G 50024				
	MO68			Interior Glazing Gasket 3 mm	000 M/PK
	1008			Interior Glazing Gasket 3 mm	000 M/PK
	1001			Interior Glazing Gasket 1.3 mm	000 M/PK
	1002			Interior Glazing Gasket 2 mm	000 M/PK
		Brush			
	50000154	Plastic Metal Dust collector			
	GP-101				
	AL 229				

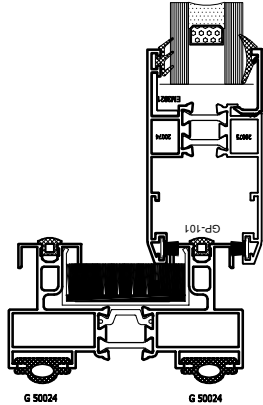
PICTURE	PIECE NO	MATERIAL	DESCRIPTION	
	20074			
	20075			
	20654			
	1126			
	220			
	10196			
	20108			
	913180			
	911148			
	913148			
	911180			
	915240			

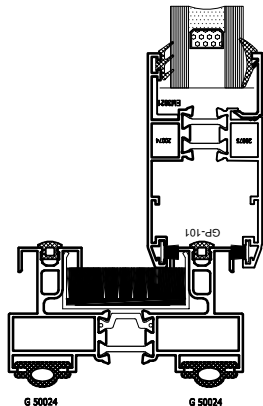
PICTURE	PIECE NO	MATERIAL	DESCRIPTION
	EM38-21		
	A 1001		
	50000154	Plastic Metal Dust collector	
	370046		

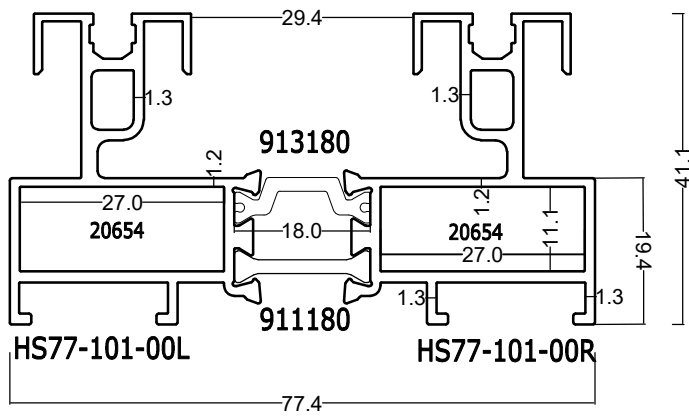

profiles frame	
code	THS77-101-00
weight	1.6061 kg/m

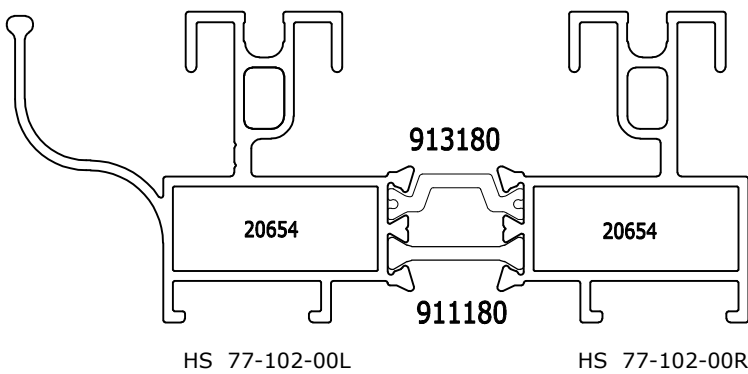

profiles frame	
code	THS77-102-00
weight	1.7494 kg/m

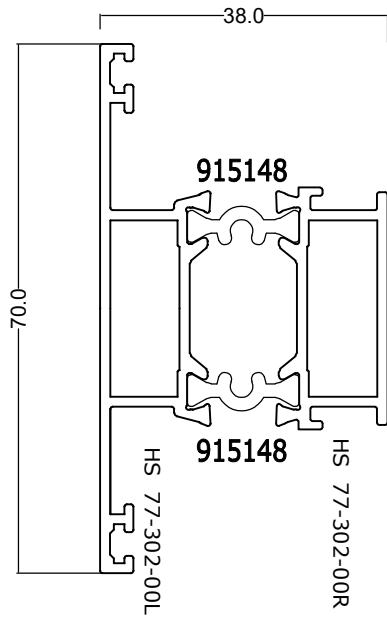

profiles frame	
code	THS77-302-00
weight	1.007 kg/m

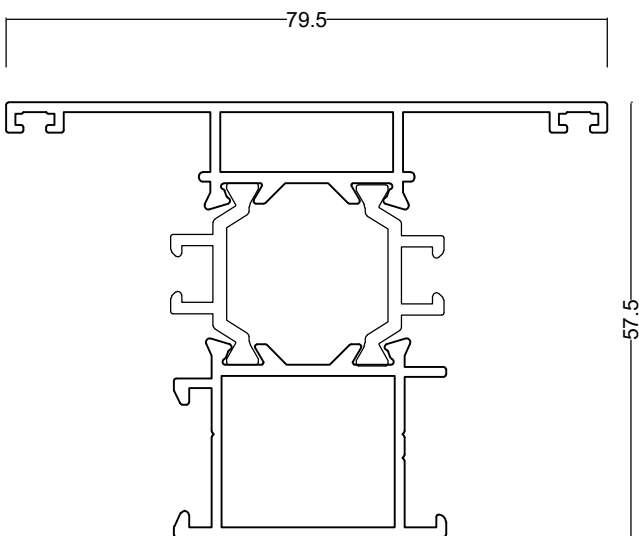

profiles frame	
code	THS77-303-00
weight	1.499

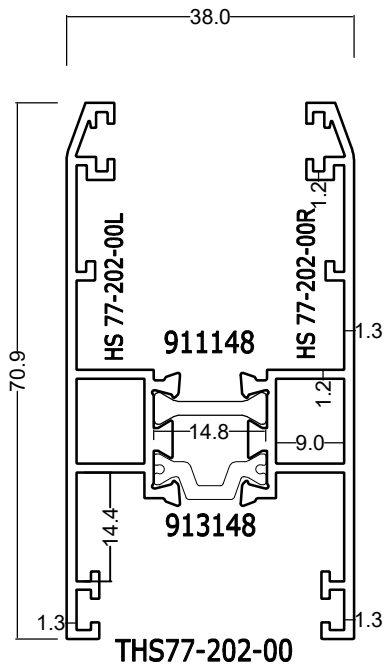

profiles frame	
code	THS77-202-00
weight	1.142 kg/m

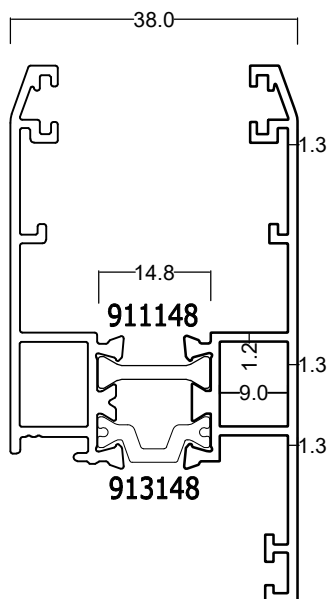

profiles frame	
code	THS77-201-00
weight	1.055 kg/m



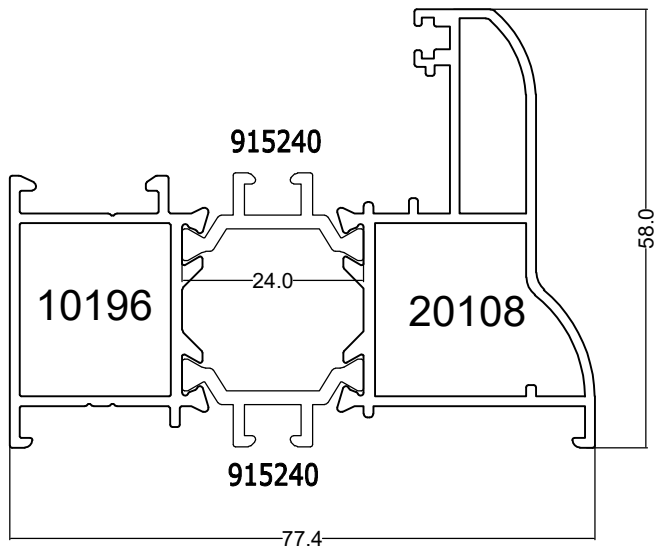

profiles frame	
code	THS77-108-00
weight	1.3992 kg/m

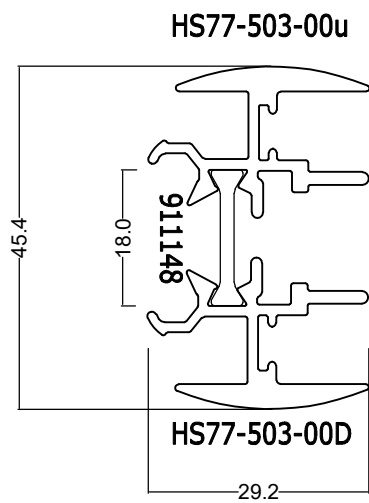

profiles frame	
code	THS77-503-00
weight	0.911 kg/m

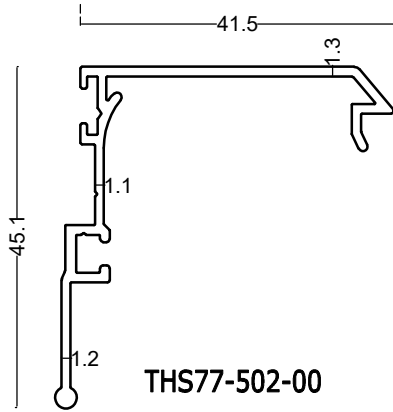

profiles frame	
code	THS77-502-00
weight	0.4346 kg/m

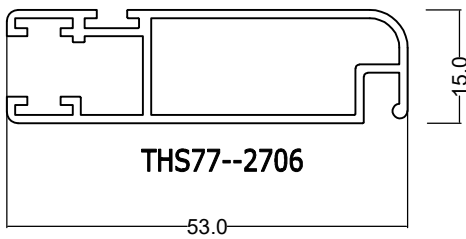

profiles frame	
code	THS77--2706
weight	0.502 kg/m

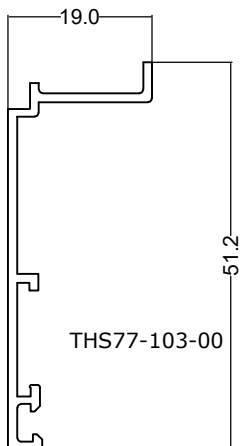

profiles frame	
code	THS77-103-00
weight	0.124 kg/m

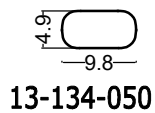

profiles frame	
code	<b>13-134-050</b>
weight	0.1240 kg/m

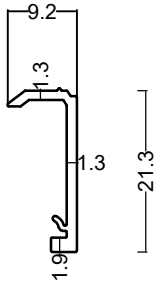

THS77-801-00

profiles frame	
code	THS77-801-00
weight	0.1378 kg/m

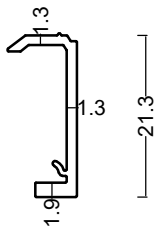

THS77-802-00

profiles frame	
code	THS77-802-00
weight	0.1378 kg/m

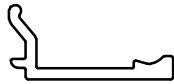

HS77-803-00

profiles frame	
code	HS77-803-00
weight	0.1378 kg/m

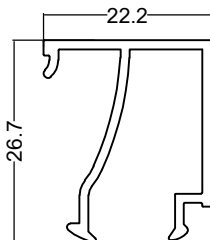

profiles frame	
code	THS77-802--00
weight	0.2936 kg/m

