

Profile No.	weight(kg/m)
كود پروفيل	وزن پروفيل
ALH-40	0.664
ALH-05	0.575
ALH-06	0.721
ALH-41	0.575

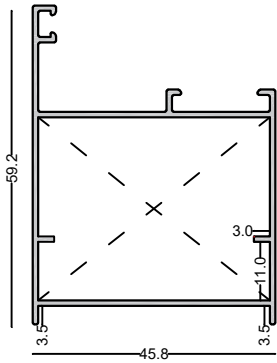

ALH-41

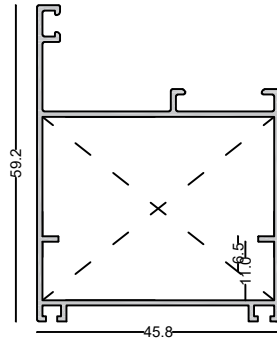

ALH-40

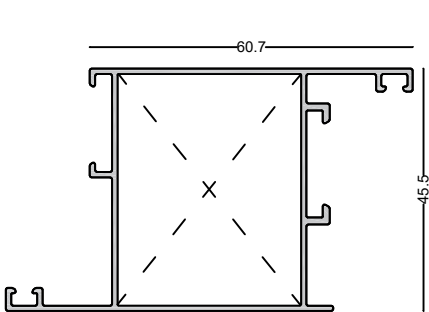

ALH-06 (10307)

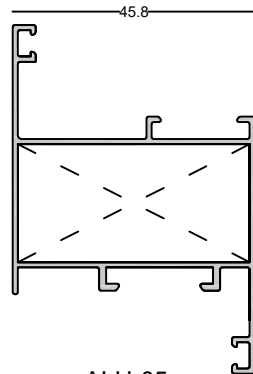

ALH-05

SC:1/1

Profile No.	weight(kg/m)
کد پروفیل	وزن پروفیل
ALH-10	0.651
ALH-35	0.813

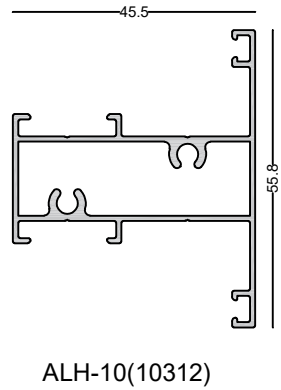
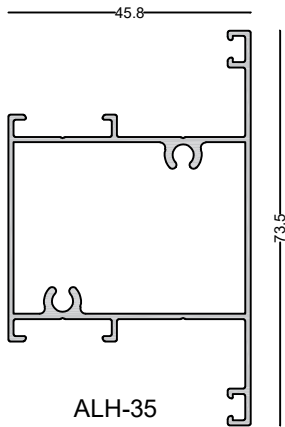

Profile No.	weight(kg/m)
ڪوڊ پروفيل	وزن پروفيل
ALH-25	0.265
ALH-30	0.245
ALH-5930	0.172
ALH-5920	0.875

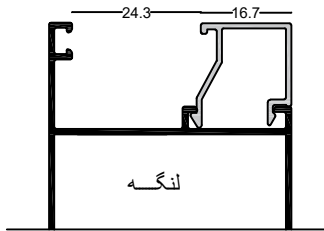

ALH-25(10313)

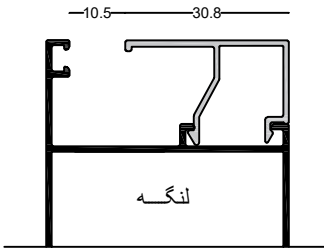
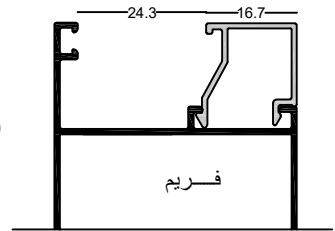

ALH-30 قالب جديد

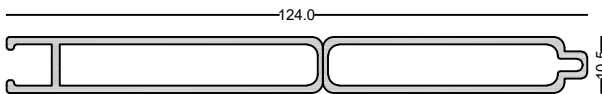
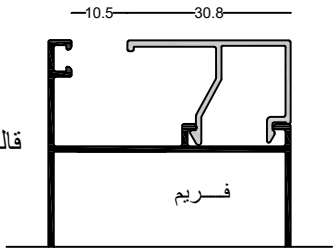

ALH-5920

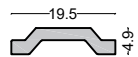

ALH-5930